

Before Starting Installation

CHECK BOX CONTENTS: ACS 160, User's Manual, Mounting Template
 CHECK INSTALLATION SITE: $U_{supply} = 380...500$ V (3-phase), correct type and size of supply fuses installed, see ACS 160 User's Manual, Reference Section Q, $U_{motor} = 380...500$ V (3-phase), $I_{motor} \leq I_{2N}$ converter (see nameplates), $T_{amb} = 0...40$ C. For more information, see Reference Sections A, B, C.
 TOOLS NEEDED: Screwdrivers, wire stripper, four $\varnothing = 5$ mm screws, drill for screws, cable glands (see Reference Section I).
 Write down motor nominal values from its nameplate: voltage, motor current, frequency, speed, power, Cos Phi.

Installation



ENSURE MAINS SUPPLY TO INSTALLATION IS OFF. CIRCUIT BOARDS CONTAIN DANGEROUS VOLTAGES WHEN MAINS IS CONNECTED.



ENSURE MOTOR IS SUITABLE FOR USE WITH ACS 160. ACS 160 MUST BE INSTALLED BY A COMPETENT PERSON. IF IN DOUBT DO NOT INSTALL.

1

Remove the wall mounting template from the packing box.

- ACS160 can be mounted either vertically or horizontally, see figures for minimum air flow gaps (mm).
- Using the mounting template, mark four fixing holes and drill them. Screw in the fixing screws or the affix nuts and bolts depending on mounting surface.
- Position the ACS 160 onto the fixing screws and securely tighten the screws.

Note! Lift ACS 160 by its metal parts only.

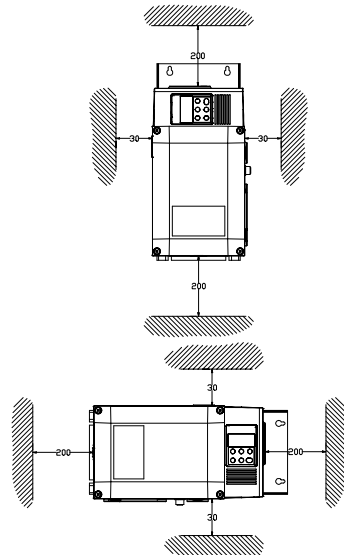

2

- Remove the metal cover of the ACS 160 by unscrewing the four screws.
- Remove the plugs from the necessary cable entries, see Figure 1.

Mount the cable glands to the entries, see Figure 2 (M25 or M20, see User's Manual Reference Section I). Make sure the glands have sealing O-rings.

- Follow local rules for mains and motor cable cross sections (normally 2,5 mm² (AWG14) wire is suitable).
- Strip the ends of mains and motor cables.

If a shielded motor cable is used to minimise radio frequency interference, twist the shield wires to a bundle at both ends.

- Lead the mains and motor cables through the cable glands and connect them to connectors U1, V1, W1 and U2, V2, W2, see Figure 2.

Be sure to connect the PE wires. Motor cable shield is also connected to the PE. In units with built-in RFI filter the PE screws are located at the filter base plate.

- Make sure that the motor wires at the motor end are connected in the same order as at the converter end. Connect shield wires to motor PE.

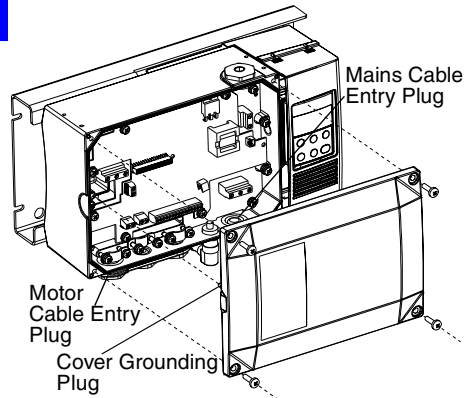

Figure 1

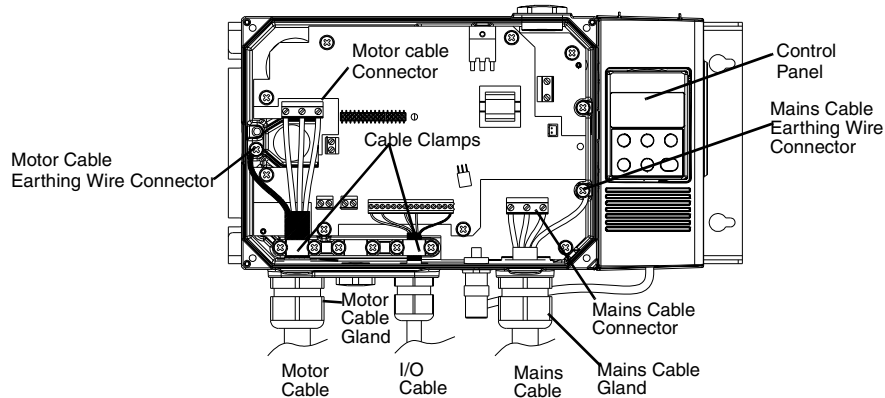

Figure 2

NOTE! Fuses are not included with the ACS 160. Please ensure correct fuses are installed on the supply distribution board, see ACS 160 User's Manual, Reference Section Q.

3

I/O TERMINAL (X1) WIRING

- The ACS 160 can be controlled either by control panel (LOCAL control mode) or through I/O terminals (REMOTE control mode). The figure beside is an example of remote control through I/O terminals.
- Lead the control cable through the cable gland and connect the appropriate wires to the main I/O terminal.
Use cable clamp to ground the control cable shield, see Figure 2.

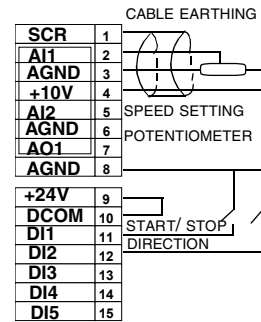

4

REPLACE THE CONVERTER COVER. (Make sure the grounding plug of the converter is inserted in its place, see Figure 1, and tighten the four screws.)

STOP!



CHECK that starting the motor does not cause any danger. If there is a risk of damage to the driven equipment in case of incorrect rotation direction of the motor, disengage the driven equipment when the first start is performed.





5 Start-up

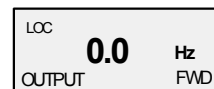
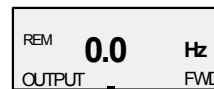

SWITCH ON THE MAINS

- After a few seconds the control panel will wake up and show the OUTPUT mode. Converter is in the REMOTE control mode (REM is displayed in the panel).
- Set the control mode to LOCAL by pressing and holding the Menu (MENU) and Enter (ENTER) buttons down until "LOC" is displayed in the panel.
- Enter the motor information by setting the values of the following parameters, see item 6 how to do this:
 - 9905 MOTOR NOM VOLT
 - 9906 MOTOR NOM CURR
 - 9907 MOTOR NOM FREQ
 - 9908 MOTOR NOM SPEED
 - 9909 MOTOR NOM POWER
 - 9910 MOTOR COS PHI



Instructions for setting the parameters:

- Press Menu  button to enter the menu. Press Enter  button to select the start-up group 99. Select the parameter with Up  and Down  buttons (for example 9905).

Select the next parameter to be changed with Up  and Down  buttons and change its value.

- After setting all the start-up parameters listed in item 5, press Menu  button twice to resume OUTPUT display. For further information refer to the ACS 160 User's Manual.

LOC	- 99 -	MENU FWD
-----	--------	----------





LOC	9905	PAR FWD
-----	------	---------

LOC	400	V FWD
	SET	

THE DRIVE IS NOW READY TO RUN.

- Press START/STOP  button to run the motor.
- Check the rotation direction.

According to standards the rotation direction should be clockwise when looking at the axle end of the motor. If not the order of two motor cable wires at the motor cable connector in converter should be changed. To do this stop the motor by pressing START/STOP button. Disconnect the mains. Wait for 5 minutes before opening the converter cover and do the reconnection.

- The motor speed can be changed by pressing Up  and Down  buttons on the control panel to alter the speed reference.
- To stop the motor press START/STOP  button.
- When controls connected to the I/O terminals want to be used, change the converter from LOCAL control REMOTE control by pressing and holding simultaneously Menu  and Enter  buttons down until "REM" is displayed in the panel.