











Electrical Safety

This equipment complies with the requirements of CEI/IEC 61010-1:2001-2 'Safety Requirements for Electrical Equipment for Measurement, Control and Laboratory Use'. If the equipment is used in a manner NOT specified by the Company, the protection provided by the equipment may be impaired.

Symbols

One or more of the following symbols may appear on the equipment labelling:

	Warning – Refer to the manual for instructions		Direct current supply only
	Caution – Risk of electric shock		Alternating current supply only
	Protective earth (ground) terminal		Both direct and alternating current supply
	Earth (ground) terminal		The equipment is protected through double insulation

Information in this manual is intended only to assist our customers in the efficient operation of our equipment. Use of this manual for any other purpose is specifically prohibited and its contents are not to be reproduced in full or part without prior approval of the Technical Publications Department.

Health and Safety

To ensure that our products are safe and without risk to health, the following points must be noted:

1. The relevant sections of these instructions must be read carefully before proceeding.
2. Warning labels on containers and packages must be observed.
3. Installation, operation, maintenance and servicing must only be carried out by suitably trained personnel and in accordance with the information given.
4. Normal safety precautions must be taken to avoid the possibility of an accident occurring when operating in conditions of high pressure and/or temperature.
5. Chemicals must be stored away from heat, protected from temperature extremes and powders kept dry. Normal safe handling procedures must be used.
6. When disposing of chemicals ensure that no two chemicals are mixed.

Safety advice concerning the use of the equipment described in this manual or any relevant hazard data sheets (where applicable) may be obtained from the Company address on the back cover, together with servicing and spares information.

GETTING STARTED

This manual is divided into five sections which contain all the information needed to install, configure, commission and operate the DATUM L160. Each section is identified clearly by a symbol as shown below.



Displays and Controls

- Displays and function keys
- LED indication
- Error messages



Operator Mode (Level 1)

- Operator menus for:
 - Standard level indicator
 - Maximum/minimum/average level indicator
 - Level indicator with volume indication



Set Up Mode (Level 2)

- Alarm trip points
- Alarm hysteresis levels



Configuration Mode (Levels 3 and 4)

- Accessing the configuration levels
- Level 3
 - Hardware assignment and input type
 - Alarm types and hysteresis
 - Operator functions
 - Digital input and serial communications
- Level 4
 - Ranges and passwords



Installation

- Siting
- Mounting
- Electrical connections

Symbol Identification and Section Contents

CONTENTS

1	DISPLAYS AND FUNCTION KEYS	3
1.1	Introduction	3
1.2	Use of Function Keys	4
1.3	LED Alarms and Indicators	5
1.4	Error Messages	6
2	OPERATOR MODE	7
2.1	Introduction	7
2.2	Operating Page – Standard (Level 1)	8
2.3	Operating Page – Max./Min./Average Functions (Level 1)	9
2.4	Operating Page – Volume Function (Level 1)	11
3	SET UP MODE	12
3.1	Introduction	12
3.2	Set Up Level (Level 2)	13
4	CONFIGURATION MODE	16
4.1	Introduction	16
4.2	Accessing the Configuration Mode	18
4.3	Basic Hardware and Indicator Functions (Level 3)	18
4.4	Ranges and Passwords (Level 4)	28
5	INSTALLATION	30
5.1	Siting the System	31
5.2	Siting the Instrument	32
5.3	Mounting the Instrument	34
5.4	Electrical Connections	36
5.5	Relays, Arc Suppression, Outputs and Input	38
	SPECIFICATION	39

Note.

The fold-out page attached to the back cover of this manual shows all frames in the programming levels. Space is provided next to each frame to record programmed settings/selections.

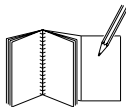

1 DISPLAYS AND FUNCTION KEYS

1.1 Introduction – Fig. 1.1

The DATUM L160 front panel display, function keys and LED indicators are shown in Fig. 1.1.

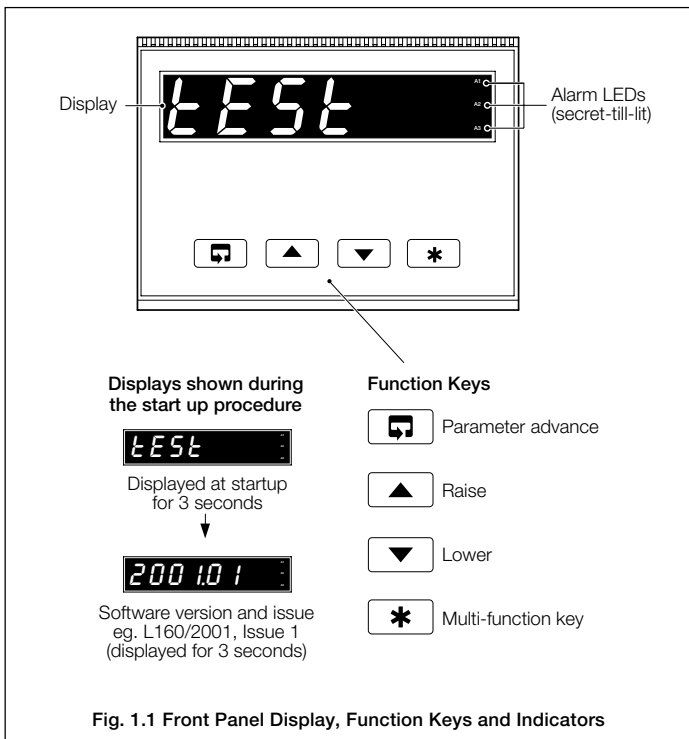

1.2 Use of Function Keys – Fig. 1.2

A – Raise and Lower Keys

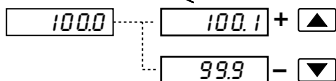

Use to change/set a parameter value... or...

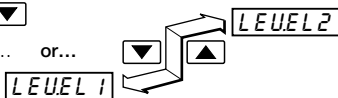

...move between levels

B – Parameter Advance Key

LEVEL 1 Frame 1
(top of level)

100.1 Frame 2 or...

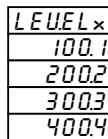
Press for
a few
secondsUse to advance to the next
frame within a level......select the top (LEVEL)
frame from within a level**Note.** This key also stores any changes made in the previous frame

C – Multi-function Key



CodE

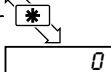

Use to view a parameter setting or selection...or...

123456



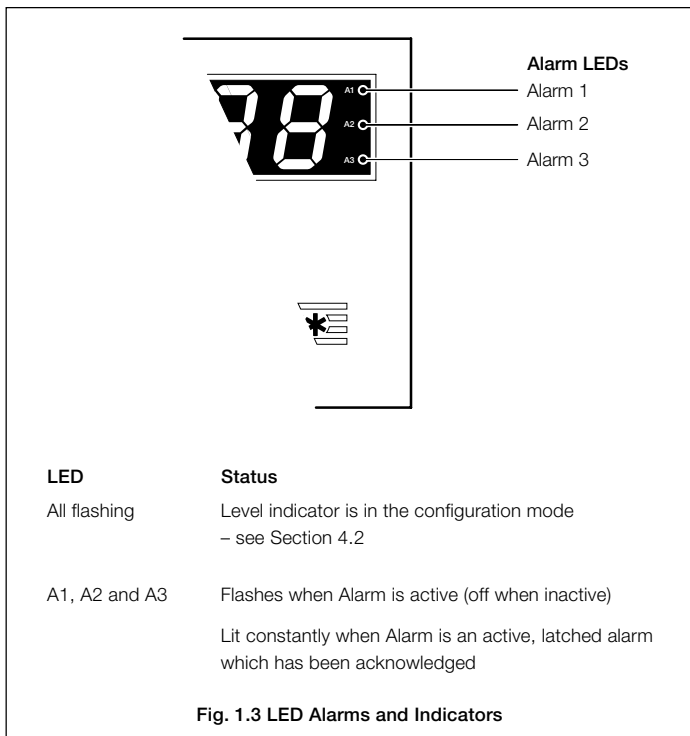

...select individual
characters in a frame

Fig. 1.2 Use of Function Keys

1.3 LED Alarms and Indicators – Fig. 1.3

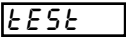
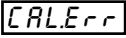

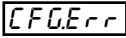
1.4 Error Messages

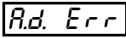
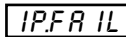
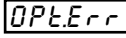
Display	Error/Action	To Clear Display
	Start-up Screen Displayed at system start-up.	Clears automatically (after 3 secs.) to display software version/issue – see Fig. 1.1.
	Calibration error Turn mains power off and on again (if the error persists contact the Service Organization).	Press the  key.
	Configuration error The configuration and/or setup data for the instrument is corrupted. Turn mains power off and on again (if the error persists, check configuration/setup settings).	Press the  key.
	A to D Converter fault The analog to digital converter is not communicating correctly.	Turn mains power off and on again. If the fault persists, contact the Service Organization.
	Sensor input out of range	Restore valid sensor input. Check sensor output.
	Option board error Communications to the option board have failed.	Contact the Service Organization.



2 OPERATOR MODE

2.1 Introduction

Operator Mode (Level 1) is the normal day-to-day mode of the DATUM L160.

Frames displayed in Level 1 are determined and limited by the indicator functions which are selected during configuration of the instrument – see Section 4.

Note. Only the operating frames relevant to the configured functions are displayed in Operator Mode.

The three indicator functions are:

- **Standard Level Indicator** – page 8
- **Level Indicator with Max./Min./Average** – page 9
- **Level Indicator with Volume Indication** – page 11



2.2 Operating Page – Standard (Level 1)

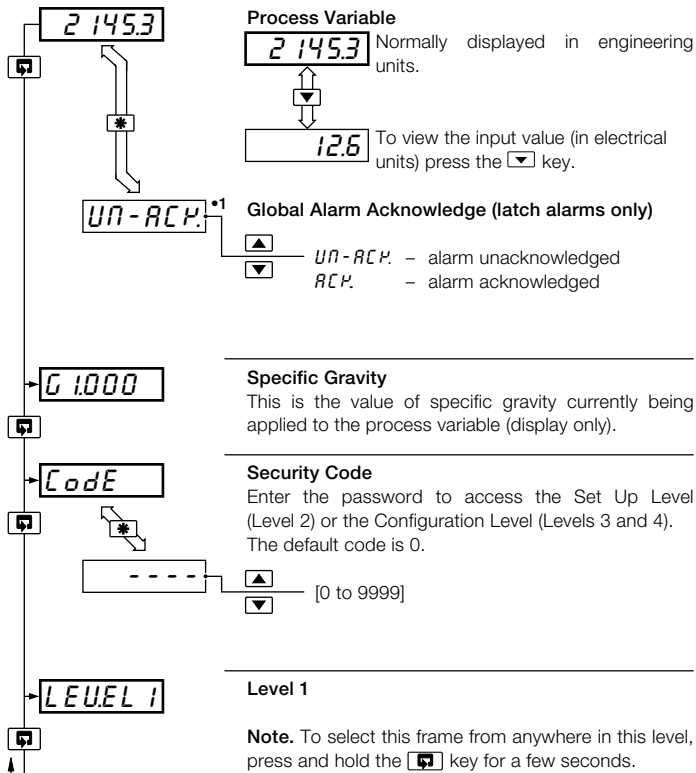

•1 Displayed only if there is an active latch alarm.



2.3 Operating Page – Max./Min./Average Functions (Level 1)

See Section 4.3.3 for details of Max./Min./Average functions.

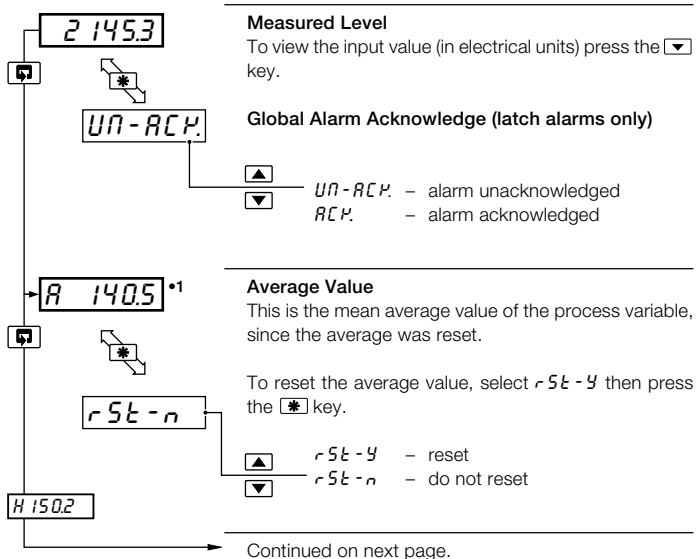

- 1 The average value is displayed only if enabled in the configuration level – see Section 4.3.3

The average value is reset automatically on power-up and can also be reset from a digital input – see Section 4.3.4.



...2.3 Operating Page – Max./Min./Average Functions (Level 1)

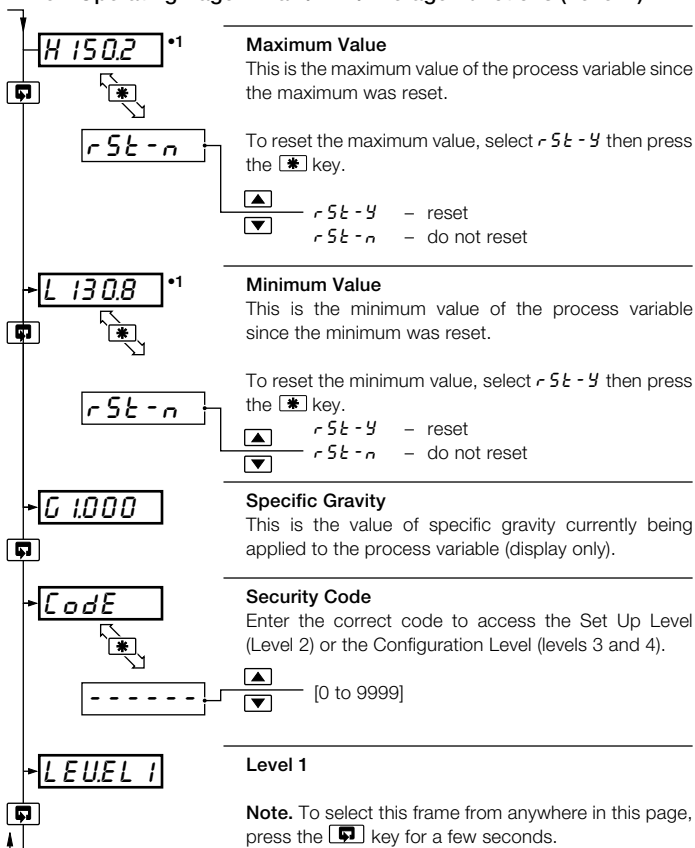

•1 The maximum and minimum values are reset automatically on power-up and can also be reset from a digital input – see Section 4.3.4.



2.4 Operating Page – Volume Function (Level 1)

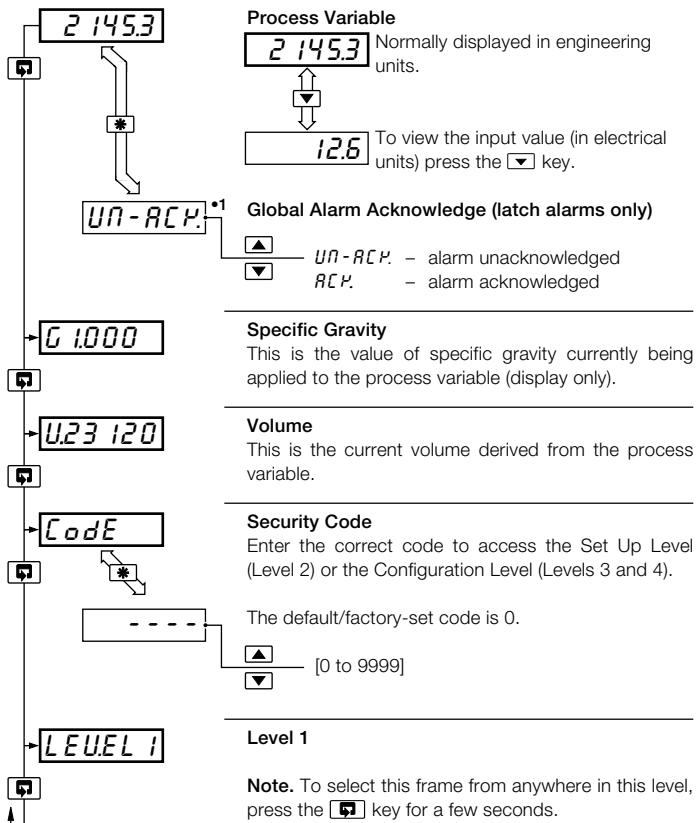

*1 Displayed only if there is an active latch alarm.

3.1 Introduction

To access the Set Up Level (Level 2) the correct code must be entered in the security code frame (CODE) in Level 1 – see Sections 2.2 to 2.4.

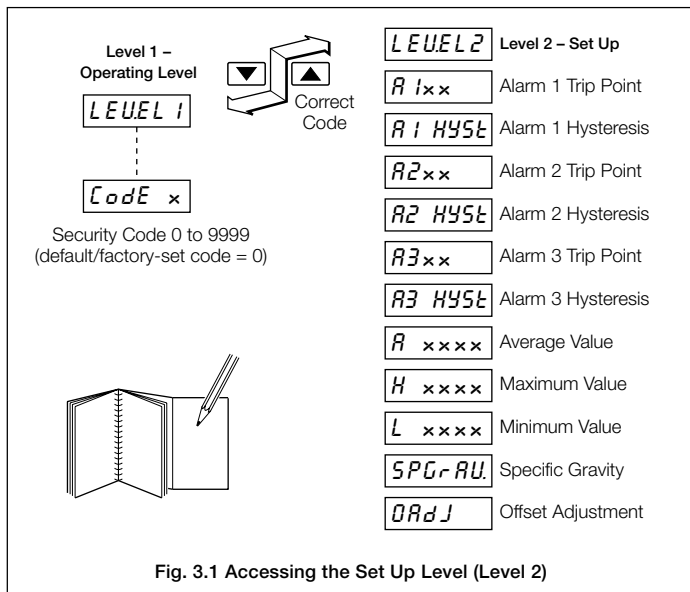

Fig. 3.1 Accessing the Set Up Level (Level 2)



3.2 Set Up Level (Level 2)

LEVEL 2

Level 2

Note. To select this frame from anywhere in this level, press the key for a few seconds.

A1hP *1

Alarm 1 Trip Point

Alarm type: *A1hP* = High level alarm
A1lP = Low level alarm
A1HL = Latched high level alarm
A1LL = Latched low level alarm
A1Fr = Fast rate level alarm
A1Sr = Slow rate level alarm

100.1

[In engineering units or % of engineering span per hour]

A1HYSE *2

Alarm 1 Hysteresis

Not applicable to *A1Fr* and *A1Sr* alarm type.

1000

[Process alarms – engineering units]

A2LP *1

Alarm 2 Trip Point

Alarm type

200.2

[In engineering units or % of engineering span per hour].

A2HYSE *2

Alarm 2 Hysteresis

Not applicable to *A2Fr* and *A2Sr* alarm type.

200

[in % engineering range]

A3hP

Continued on next page...

- 1 Not displayed if the alarm is disabled ('None' selected) – see Section 4.3.2.
- 2 Displayed only if custom alarm hysteresis is selected – see Section 4.3.2. (not displayed for rate alarms).

...3.2 Setup Level (Level 2)

A3.hP •1

Alarm 3 Trip Point
Alarm type

▲ [In engineering units or % engineering span per hour]
▼

3003

A3 HYS •2

Alarm 3 Hysteresis
Not applicable to *A3.Fr* and *A3.Sr* alarm type.

▲ [Process alarms – engineering units]
▼

34.6

A 1405 •3

Average Value
This is the mean average value of the process variable input since the average was reset.

To reset the average value, select *r 5t - y* then press the * key.

▲ *r 5t - y* – reset
▼ *r 5t - n* – do not reset

L 1308

Continued on next page...

- 1 Not displayed if the alarm is disabled ('None' selected) – see Section 4.3.2.
- 2 Displayed only if custom alarm hysteresis is selected – see Section 4.3.2. (not displayed for rate alarms).
- 3 The average value is reset automatically on power-up and can also be reset from a digital input – see Section 4.3.3.



...3.2 Set Up Level (Level 2)

H 150.2 •1

Maximum Value
This is the maximum value of the level input since the maximum was reset.

To reset the maximum value, select *rSt-y* then press the ***** key.

▲ *rSt-y* - reset
▼ *rSt-n* - do not reset

L 130.8 •1

Minimum Value
This is the minimum value of the level input since the minimum was reset.

To reset the minimum value, select *rSt-y* then press the ***** key.

▲ *rSt-y* - reset
▼ *rSt-y* - do not reset

SPG rAU.

Specific Gravity

▲ Enter the specific gravity of the liquid to be measured.
▼

0.RdJ

Offset Adjustment
An offset can be applied to the level input to enable spot calibration or the removal of system errors.

▲ [±10% of engineering range].
▼

- 1 The maximum and minimum values are reset automatically on power-up and can also be reset from a digital input – see Section 4.3.3.



4 CONFIGURATION MODE

4.1 Introduction – Fig. 4.1

The Configuration Mode comprises two levels (3 and 4) as shown in Fig. 4.1.

Level 3 is divided into four frames. For most simple applications it is only necessary to set up the parameters in the first frame.

Note.

When in the Configuration Level:

- All the LED indicators flash.
 - All relays and logic outputs are turned off.
 - The analog output reverts to 0% (4mA) output level.
-



...4.1 Introduction – Fig. 4.1

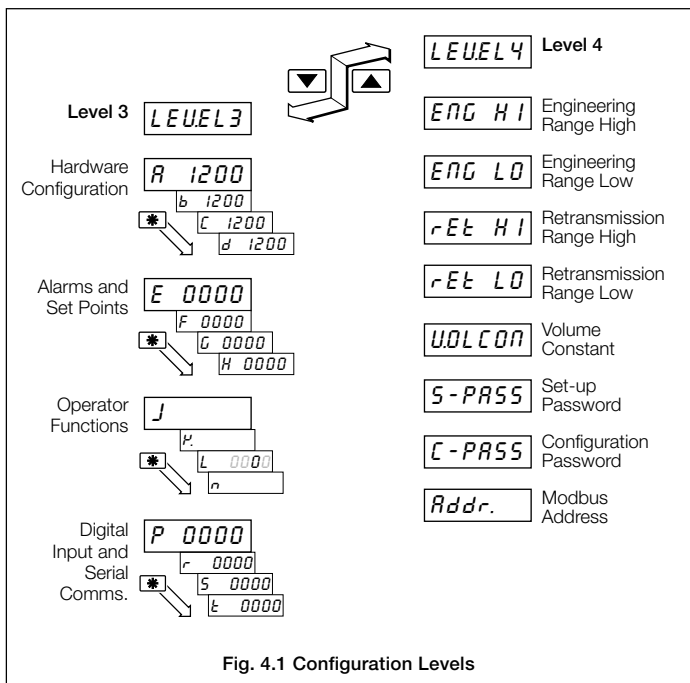



4.2 Accessing the Configuration Mode

To access the Configuration Mode, enter the correct configuration code in Level 1 – see Sections 2.2 to 2.4. The Configuration password is set up in Level 4.

4.3 Basic Hardware and Indicator Functions (Level 3)

4.3.1 Hardware Assignment and Input Type – Fig. 4.2

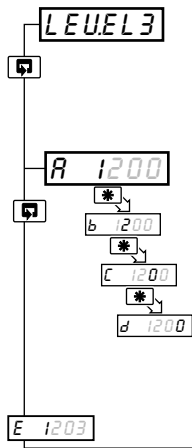

Level 3

Note. To select this frame from anywhere in this level, press the  key for a few seconds.

'ABCD' Settings

The first character (A, B, C or D) identifies the parameter to be changed. The current setting is indicated by a flashing letter. Parameter options are shown in Fig. 4.2.

- R* = Hardware configuration
- b* = Input type and range
- c* = Not applicable
- d* = No. of decimal points

Note. For custom settings contact the local distributor.

Continued on page 20.



...4.3.1 Hardware Assignment and Input Type – Fig. 4.2

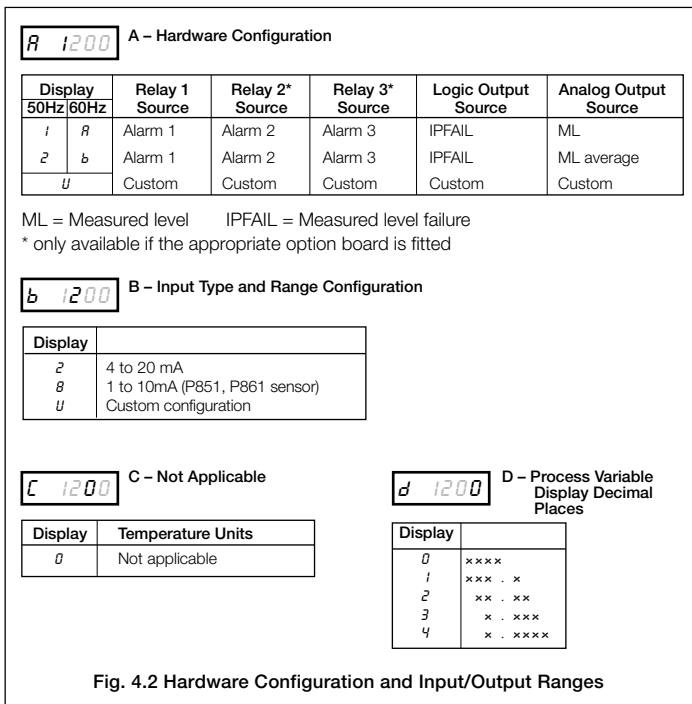



.3.2 Alarms – Figs. 4.3, 4.4, 4.5 and 4.6

All alarms output relays are de-energized in the alarm state (fail safe).

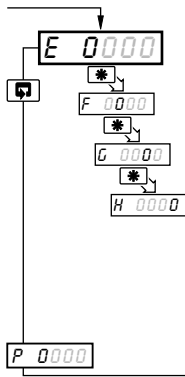

'EFGH' Settings

The first character (E, F, G or H) identifies the parameter to be changed. The current setting is indicated by a flashing letter. Parameter options are shown in Fig. 4.3.

- E* = Alarm 1 type
- F* = Alarm 2 type
- G* = Alarm 3 type
- H* = Alarm hysteresis

Note. For fail safe operation, active alarms denegize the relay and inactive alarms energize the relay. For custom settings contact the local distributor.

Continued on page 25.



...4.3.2 Alarms – Figs. 4.3, 4.4, 4.5 and 4.6

E 0000 E – Alarm 1 Type

Display	
0	None
1	High Process
2	Low Process
3	High Latch
4	Low Latch
5	Fast Rate
6	Slow Rate

F 0000 F – Alarm 2 Type

Display	
0	None
1	High Process
2	Low Process
3	High Latch
4	Low Latch
5	Fast Rate
6	Slow Rate

G 0000 G – Alarm 3 Type

Display	
0	None
1	High Process
2	Low Process
3	High Latch
4	Low Latch
5	Fast Rate
6	Slow Rate

h 0000 H – Alarm Hysteresis

Display	
0	None
1	0.1%
2	0.2%
3	0.5%
4	1.0%
5	2.0%
6	5.0%
U	Custom

Value in % of engineering range

See Note

Note. When custom alarm hysteresis is selected, the alarm hysteresis values must first be set individually in the **Set Up Level** – see Section 3.2

Fig. 4.3 Alarm Types



...4.3.2 Alarms – Figs. 4.3, 4.4, 4.5 and 4.6

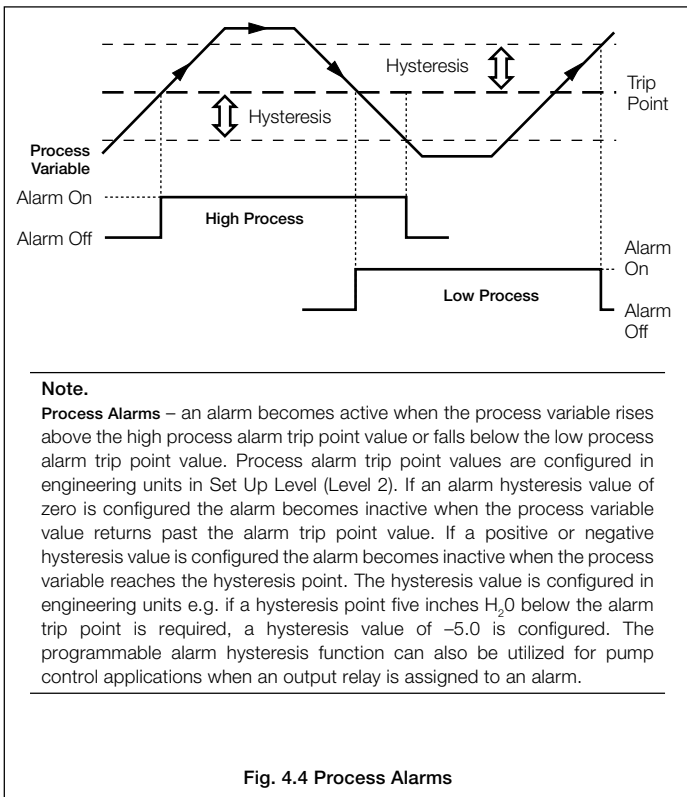

Note.

Process Alarms – an alarm becomes active when the process variable rises above the high process alarm trip point value or falls below the low process alarm trip point value. Process alarm trip point values are configured in engineering units in Set Up Level (Level 2). If an alarm hysteresis value of zero is configured the alarm becomes inactive when the process variable value returns past the alarm trip point value. If a positive or negative hysteresis value is configured the alarm becomes inactive when the process variable reaches the hysteresis point. The hysteresis value is configured in engineering units e.g. if a hysteresis point five inches H₂O below the alarm trip point is required, a hysteresis value of -5.0 is configured. The programmable alarm hysteresis function can also be utilized for pump control applications when an output relay is assigned to an alarm.

Fig. 4.4 Process Alarms



...4.3.2 Alarms – Figs. 4.3, 4.4, 4.5 and 4.6

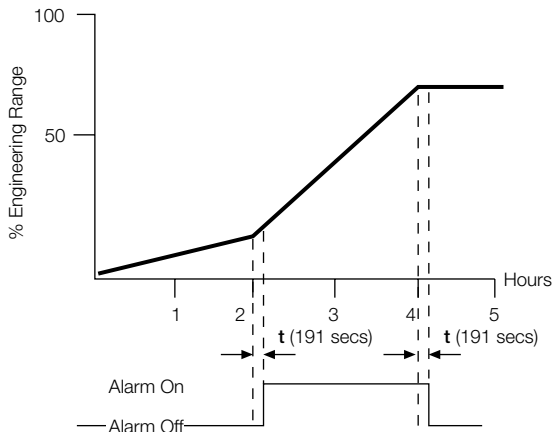

Note.

Fast/Slow Rate Alarms – an alarm becomes active when the rate of change in the process variable is faster or slower than the configured alarm value. Rate of change alarm values are configured as a % of span change per hour. The elapsed time period before the alarm condition is detected is dependant upon the configured alarm value. This period can be calculated as follows:

$$t = 10.81 + \frac{1800}{\text{trip value (as a \% of eng. span/hr)}}$$

$$t = 191 \text{ seconds}$$

The alarm remains active until the rate of change in the process variable returns to the non-alarm condition. The calculated time period (t) elapses between the process variable reaching the non-alarm condition and the alarm becoming inactive.

Fig. 4.5 Rate Alarms

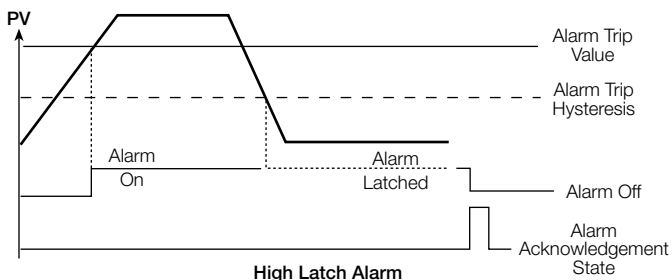

High Latch Alarm

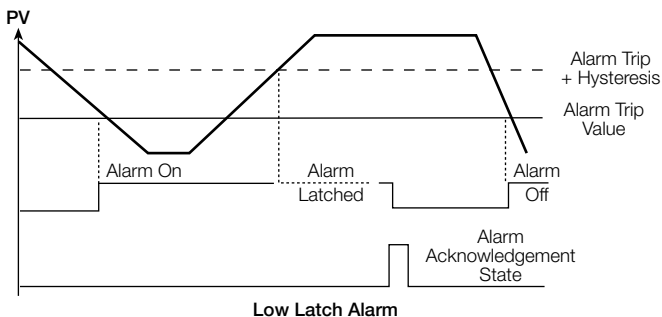

Low Latch Alarm

Note.

High/Low Latch Alarms – An alarm becomes active when the process variable value rises above the high latch alarm trip point value or falls below the low latch alarm trip point value. The latch alarm trip point values are configured in engineering units in the Set Up Level (Level 2). The alarm remains active until it is acknowledged and the alarm process condition is removed. The alarm can be acknowledged using the keys on the instrument front panel (see page 3) or via the volt-free digital input once it has been configured to provide a remote alarm acknowledge facility.

Fig. 4.6 Latch Alarms



4.3.3 Operator Functions – Fig. 4.7

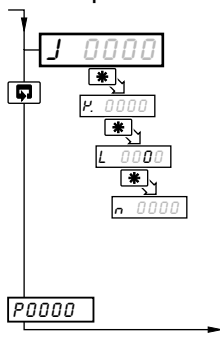

'JKLN' Settings

The first character (J, K, L or N) identifies the parameter to be changed (indicated by a flashing letter). Available parameter options are shown in Fig. 4.7 below.

- J = Not applicable
- P = Not applicable
- L = Operator Level frame enable
- n = Operator Level math reset enable

Note. For custom settings contact the local distributor.

Continued on page 26.

L 0000

Parameter Setting	Max./Min.	Average	Volume
0	X	X	X
1	X	X	✓
2	X	✓	X
3	X	✓	✓
4	✓	X	X
5	✓	X	✓
6	✓	✓	X
7	✓	✓	✓

n 0000

Parameter Setting	Max/Min./Average
0	X
1	✓

Fig. 4.7 Operator Level Maths Reset Enable



4.3.4 Digital Input and Serial Communications – Fig. 4.8 and 4.9

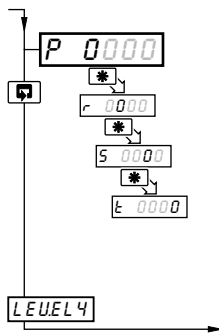

'PRST' Settings

The first character (P, R, S or T) identifies the parameter to be changed. The current setting is indicated by a flashing letter. Parameter options are shown in Fig. 4.8.

- P = Digital input function
- r = Analog input filter
- S = Serial communications configuration
- t = Serial communications parity

Note. For custom settings contact the local distributor.

Continued on page 28.

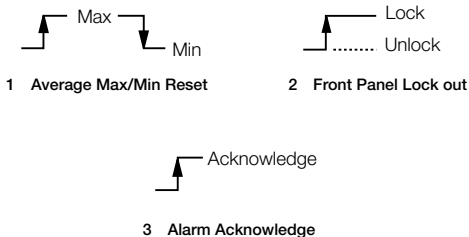

Note.

Digital input options 1, 2 and 3 are edge-triggered to enable the front panel keys to change the function when the digital input is operational.

Fig. 4.8 Digital Functions



...4.3.4 Digital Input and Serial Communications – Fig. 4.8 and 4.9

P 0000 P – Digital Input Function

Display	
0	None
1	Average, Max/Min Reset
2	Front Panel Lockout
3	Alarm Acknowledge

r 0000 R – Analog Input Filter

Display	
0	0 seconds
1	1 second
2	2 seconds
5	5 seconds
A	10 seconds
B	20 seconds
C	40 seconds
D	60 seconds

5 0000 S – Serial Communication Configuration

Display	Baud Rate, 2/4 Wire
0	Off
1	2400, 2 Wire
2	2400, 4 Wire
3	9600, 2 Wire
4	9600, 4 Wire

t 0000 T – Serial Communication Parity

Display	
0	None
1	Odd
2	Even

Note. Settings for options P, S and T are available only if the appropriate option board is fitted.

Fig. 4.9 Digital Functions and Serial Communications Configuration



4.4 Ranges and Passwords (Level 4)

LEVEL 4

Level 4

Note. To select this frame from anywhere in this level, press the  key for a few seconds.

Engineering (Display) Range

High Value
(100.0 metres)

Low Value
(0.0 metres)

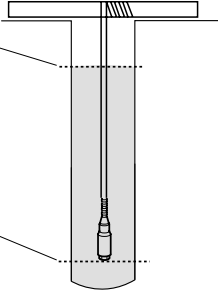

Retransmission Range
Defines the engineering range to be retransmitted.

High (20mA output)

Low (4mA output)

Navigation: A vertical line of icons on the left side of the page indicates the sequence of screens. From top to bottom: a square with a right arrow, a square with a left arrow, a square with a right arrow, a square with a left arrow, a square with a right arrow, a square with a left arrow, a square with a right arrow, and a square with a left arrow. Each icon is positioned to the left of its corresponding screen label.

Screen 1: LEVEL 4

Screen 2: ENG HI

Screen 3: 100.0 (with up/down arrow icons) [-9999 to 99999]

Screen 4: ENG LO

Screen 5: 00 (with up/down arrow icons) [-9999 to 99999]

Screen 6: rEt HI

Screen 7: 100.0 (with up/down arrow icons) [-9999 to 99999 (in engineering units)]

Screen 8: rEt LO

Screen 9: 00 (with up/down arrow icons) [-9999 to 99999 (in engineering units)].

Screen 10: WOLCON

Continued on next page...



...4.4 Ranges and Passwords (Level 4)

	<p>Volume Constant – Fig. 4.10</p> <p>This constant can be used to calculate the volume of liquid in a tank from the measured level</p> <p>1.0 [0.0 to 9999.9]</p>
	<p>Set Up Password</p> <p>The password enables access to the set up level (Level 2).</p> <p>0 [0 to 9999] Default/factory set = 0</p>
	<p>Configuration Password</p> <p>The password enables access to the configuration levels (Levels 3 and 4). The Configuration password overrides the setup password.</p> <p>0 [0 to 9999] Default/factory set = 0</p>
	<p>Modbus Address</p> <p>This frame sets the Modbus address.</p> <p>1 [1 to 99]</p>

- 1 Available only if the appropriate option board is fitted.

Cube:

$$\text{Volume} = a \times b \times L$$

$$\text{Volume Constant} = \frac{a \times b}{L}$$

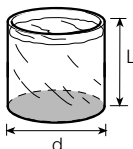
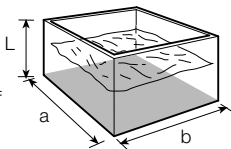

Cylinder:

$$\text{Volume} = \pi \times \left(\frac{d}{2}\right)^2 \times L$$

$$\text{Volume Constant} = \frac{\pi \times \left(\frac{d}{2}\right)^2}{L}$$

Fig. 4.10 Volume Constant Calculations



5 INSTALLATION

EC Directive 89/336/EEC

In order to meet the requirements of the EC Directive 89/336/EEC for EMC regulations, this product must not be used in a non-industrial environment.

End of Life Disposal

This instrument does not contain any substance that will cause undue harm to the environment. It can therefore be safely considered as normal waste and disposed of accordingly.

Cleaning

Clean the front panel only, using warm water and a mild detergent.



5.1 Siting the System – Fig. 5.1

Notes.

- Sensor cable runs over long distances can pick up transients which could impair operation of the L160. Transient protection within the L160 Level System gives protection against induced voltage transients of up to 2kV.
- In high humidity environments, condensation must be prevented from entering any sensor vent (breather) tubes.

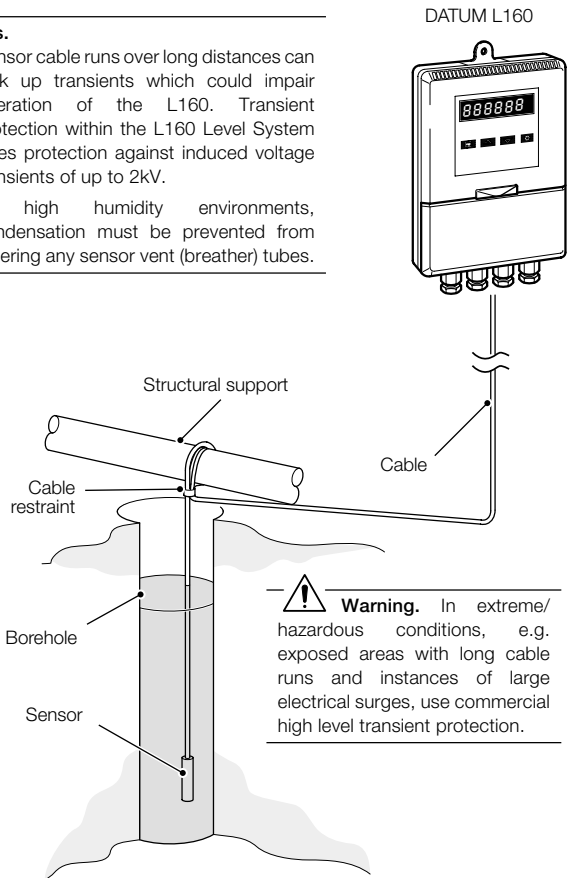
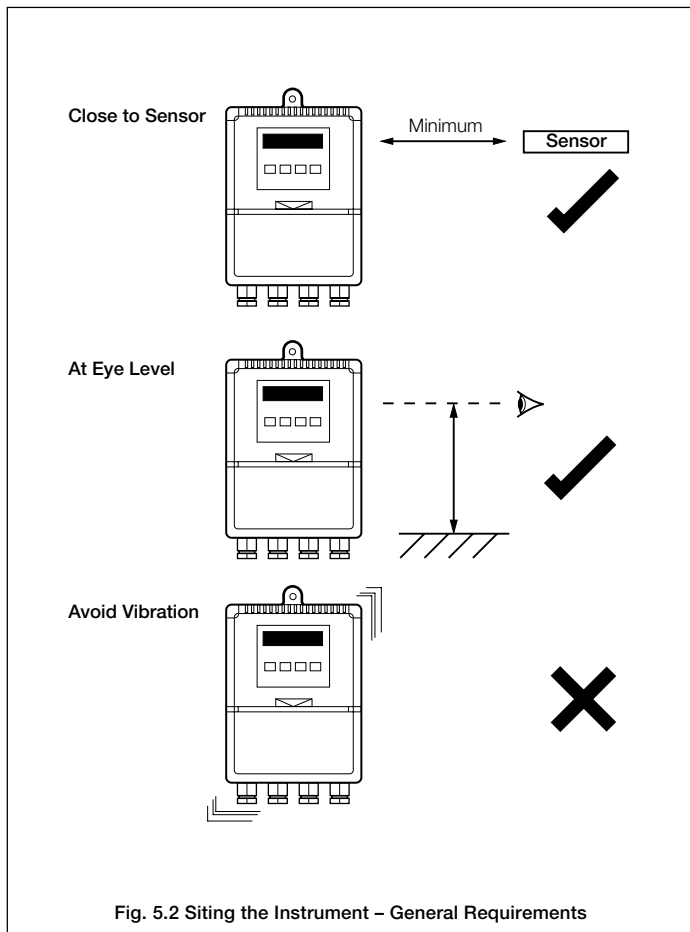

Fig. 5.1 System Installation



5.2 Siting the Instrument – Figs. 5.2 and 5.3





...5.2 Siting the Instrument – Figs. 5.2 and 5.3

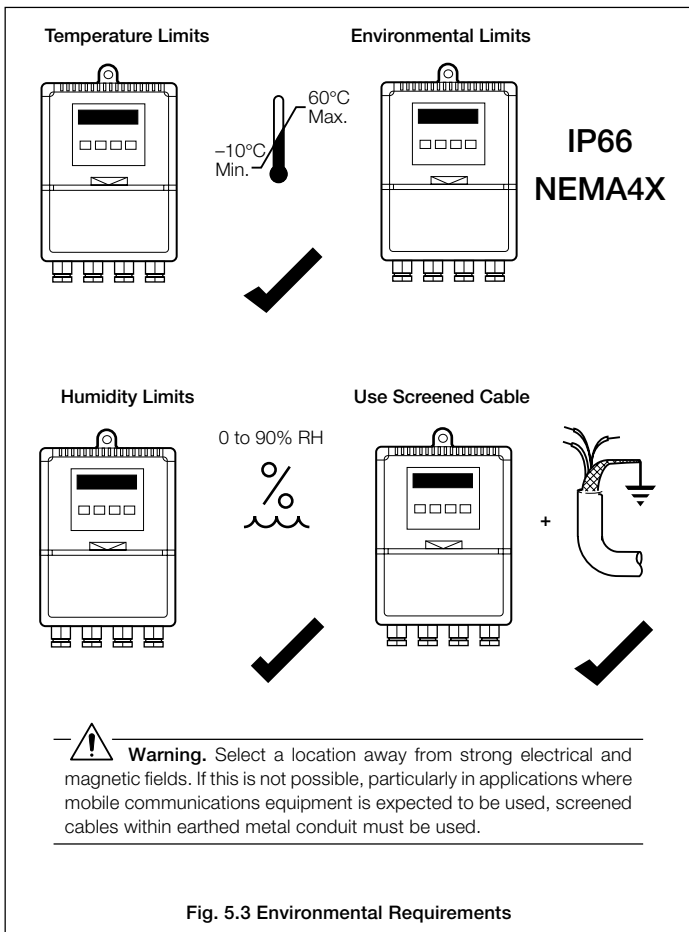
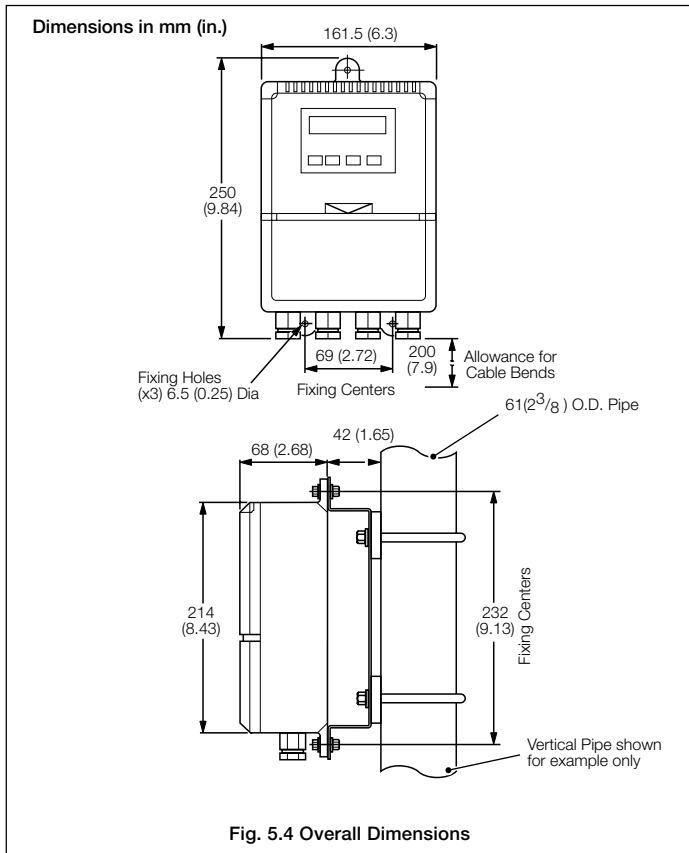

Fig. 5.3 Environmental Requirements



5.3 Mounting the Instrument – Figs. 5.4 and 5.5

The instrument is designed for wall-mounting or pipe-mounting (see Fig. 5.5). The pipe-mounting kit (part no. 4600/O138) is suitable for both vertical and horizontal pipes. Overall dimensions are shown in Fig. 5.4.





...5.3 Mounting the Instrument – Figs. 5.4 and 5.5

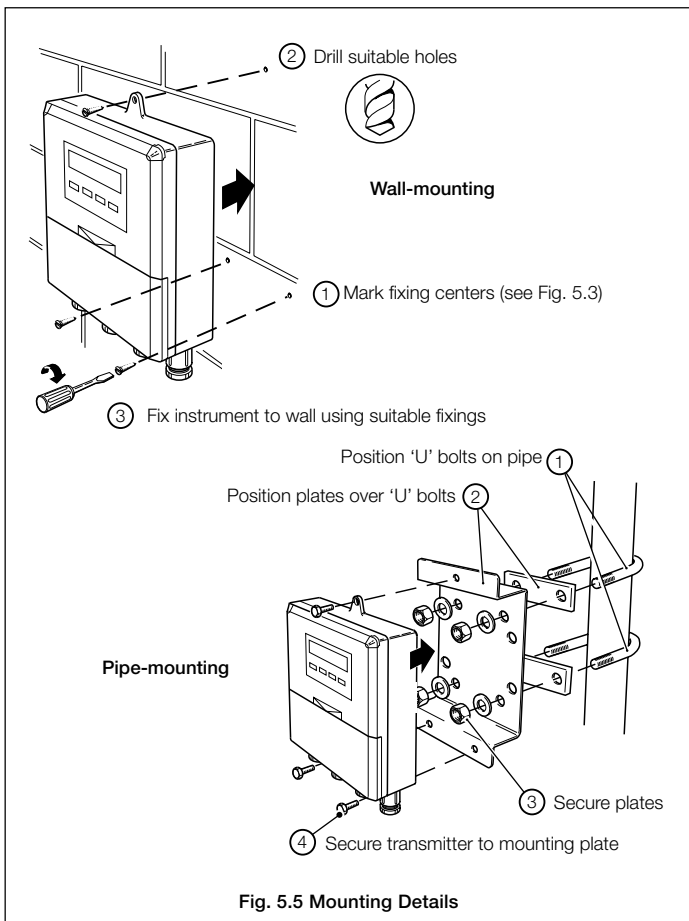



5.4 Electrical Connections – Fig. 5.6



Warning.

- The instrument is not fitted with a switch therefore a disconnecting device such as a switch or circuit breaker conforming to local safety standards must be fitted to the final installation. It must be mounted in close proximity to the instrument within easy reach of the operator and must be marked clearly as the disconnection device for the instrument
 - Remove all power from supply, relay and any powered control circuits and high common mode voltages before accessing or making any connections.
 - Use cable appropriate for the load currents. The terminals accept cables up to 14AWG (2.5mm²).
 - The instrument conforms to Mains Power Input Insulation Category 2, Pollution Degree 2 (EN601010–1).
 - All connections to secondary circuits must have basic insulation.
 - After installation, there must be no access to live parts, e.g. terminals
 - Terminals for external circuits are for use only with equipment with no accessible live parts.
 - If the instrument is used in a manner not specified by the Company, the protection provided by the equipment may be impaired.
 - All equipment connected to the instrument's terminals must comply with local safety standards (IEC 60950, EN601010–1).
-

Note.

- Always route signal leads and power cables separately, preferably in earthed (grounded) metal conduit.
 - It is strongly recommended that screened cable is used for signal inputs and relay connections.
-

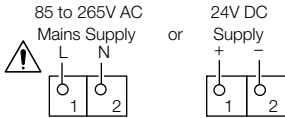

Power Connections

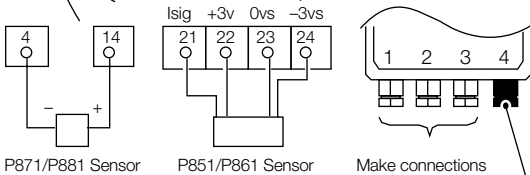
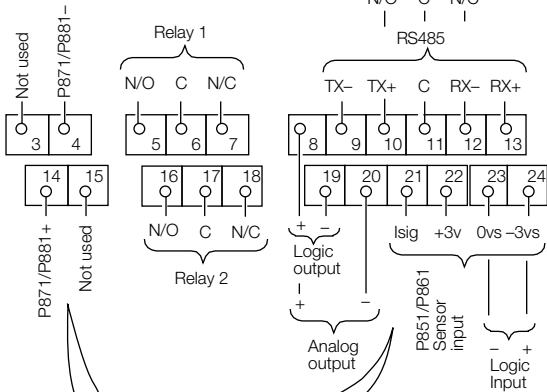

Sensor Connections



Warning. Connect earth (ground) wire and sensor screens to chassis earth stud.

Fig. 5.6 Electrical Connections



5.5 Relays, Arc Suppression, Outputs and Input

5.5.1 Relay Contact Ratings

115/230V AC at 5A (non-inductive)

250V DC 25W max.

5.5.2 Arc Suppression

Arc suppression components are fitted to relays 2 and 3 only. If relay 1 is required to switch inductive loads, fit the arc suppression components supplied.

5.5.3 Logic Output

18V DC at 20mA

Minimum load 900Ω

Isolation 500V from input (not isolated from retransmission output)

5.5.4 Retransmission Analog Output

Maximum load 15V (750Ω at 20mA)

Isolation 500V from input (not isolated from logic output).

5.5.5 Logic Input

Type: Volt-free

Minimum pulse: 250ms

SPECIFICATION

Operation

Display

High-intensity 7-segment, 1 x 5-digit LED display

Three alarm LED indicators

Display range -9999 to +99999

Display resolution ± 1 digit

Display height 14mm (0.56 in.)

Configuration

User-defined via front panel

Standard Functions

Alarms

Number Three user-defined

Types High/Low process

High/Low latch

Fast/Slow rate

Alarm hysteresis

0 to 100% of range

Math functions

Maximum and minimum value detection

Average level

SG correction

Tank volume calculation

20-breakpoint custom linearizer (factory configured)

...SPECIFICATION

Analog Inputs

Input type

1 to 10 mA, 4 to 20 mA or customize via PC Configurator

Input sampling rate

250ms

Accuracy

Indicator 0.2% of reading

Output <0.2% of span

Sensor power supply

24V, 30mA max. (powers one 2-wire transmitter)

± 3V, 15mA (power for P851/P861 sensors)*

*Option board

Outputs – Standard Build

Retransmission

Analog, configurable in the range 4 to 20mA

Max. load 15V (750 Ω at 20mA)

Isolation 500V DC from sensor input (not isolated from logic output)

Logic output

18V DC at 20mA

Min. load 400 Ω

Isolation 500V from sensor input (not isolated from retransmission output)

Relay output

One relay as standard (SPDT) 5A at 115/230V AC, assignable to alarms

Options

One build can be selected from:

Type 01	Two relays + retransmission + logic output + digital input (Standard Build)
Type 02	Three relays + retransmission + logic output + digital input
Type 03	Two relays + retransmission + logic output + digital input + Modbus
Type 04	Two relays + logic output + retransmission + P851/P861 power supply

I/O

Relay output

SPDT 5A at 115/230V AC

Assignable to alarms

Digital input

Type Volt-free

Minimum pulse 250ms

Modbus serial communications

Connections RS422/RS485, 2- or 4-wire

Speed 2.4k or 9.6k baud rate

Protocol Modbus RTU slave

Electrical

Voltage (supply)

85 to 265V AC 50/60Hz

24V DC optional

Power consumption

< 6VA (85 to 265V AC)

< 5W (24V DC)

Power interruption protection

<60ms/<3 cycles, no effect

>60ms/>3 cycles, instrument returns to operation after a controlled reset

...SPECIFICATION

Physical

Size

160mm wide x 250mm high x 68mm (6.3 in. wide x 9.84 in. high x 2.68 in.)

Weight

2kg (4.5lb)

Environmental

Operating limits

-10 to 55°C (14 to 131°F)

5 to 95% RH non-condensing

Temperature stability

<0.02% of reading or 2 μ V/°C (1 μ V/°F)

Front face

IP66 (NEMA 4X)

EMC

Emissions

Meets requirements of EN50081-2

Immunity

Meets requirements of EN50082-2

Design and manufacturing standards

CE mark

Electrical safety

EN61010-1

SS/L160 Issue 3

Customer Support

We provide a comprehensive after sales service via our Worldwide Service Organization. Contact one of the following offices for details of your nearest Service and Repair Centre.

United Kingdom

ABB Limited
Tel: +44 (0)1480 475321
Fax: +44 (0)1480 217948

United States of America

ABB Inc.
Tel: +1 215 674 6000
Fax: +1 215 674 7183

Client Warranty

Prior to installation, the equipment referred to in this manual must be stored in a clean, dry environment, in accordance with the Company's published specification. Periodic checks must be made on the equipment's condition.

In the event of a failure under warranty, the following documentation must be provided as substantiation:

1. A listing evidencing process operation and alarm logs at time of failure.
2. Copies of operating and maintenance records relating to the alleged faulty unit.

CUSTOMER SETUP LOG



LEVEL 1		LEVEL 2	_____
Code	---	R 1xx	-----
		R 1H45t	-----
		R2xx	-----
		R2H45t	-----
		R3xx	-----
		R3H45t	-----
		R xxxx	-----
		H xxxx	-----
		L xxxx	-----
		SPGrAU	-----
		ORdJ	-----

Instrument Serial Number: _____

Product Code: L 1 6 0 / _ _ _ _ / _ _ _ _



CUSTOMER CONFIGURATION LOG



LEVEL3		LEVEL4	
R 14C0		ENG HI	_____
A _ B _ C _ D _		ENG LO	_____
E 0000		rEt HI	_____
E _ F _ G _ H _		rEt LO	_____
J 0000		UOLCON	_____
J _ K _ L _ N _		S-PASS	_____
P 0000		C-PASS	_____
P _ R _ S _ T _		Addr.	_____

ABB has Sales & Customer Support expertise in over 100 countries worldwide

www.abb.com

The Company's policy is one of continuous product improvement and the right is reserved to modify the information contained herein without notice.

Printed in UK (03.06)

© ABB 2006



ABB Limited
 Howard Road, St. Neots
 Cambridgeshire
 PE19 8EU
 UK
 Tel: +44 (0)1480 475321
 Fax: +44 (0)1480 217948

ABB Inc.
 125 E. County Line Road
 Warminster
 PA 18974
 USA
 Tel: +1 215 674 6000
 Fax: +1 215 674 7183