

Dissolved Oxygen Cartridge Electrode Systems

9408 8000 Series



ABB

The Company

We are an established world force in the design and manufacture of instrumentation for industrial process control, flow measurement, gas and liquid analysis and environmental applications.

As a part of ABB, a world leader in process automation technology, we offer customers application expertise, service and support worldwide.

We are committed to teamwork, high quality manufacturing, advanced technology and unrivalled service and support.

The quality, accuracy and performance of the Company's products result from over 100 years experience, combined with a continuous program of innovative design and development to incorporate the latest technology.

The NAMAS Calibration Laboratory No. 0255 is just one of the ten flow calibration plants operated by the Company, and is indicative of our dedication to quality and accuracy.

EN ISO 9001:1994



Cert. No. Q05907

EN 29001 (ISO 9001)



Lenno, Italy – Cert. No. 9/90A

Stonehouse, U.K



0255

Information in this manual is intended only to assist our customers in the efficient operation of our equipment. Use of this manual for any other purpose is specifically prohibited and its contents are not to be reproduced in full or part without prior approval of the Technical Publications Department.

Health and Safety

To ensure that our products are safe and without risk to health, the following points must be noted:

1. The relevant sections of these instructions must be read carefully before proceeding.
2. Warning labels on containers and packages must be observed.
3. Installation, operation, maintenance and servicing must only be carried out by suitably trained personnel and in accordance with the information given.
4. Normal safety precautions must be taken to avoid the possibility of an accident occurring when operating in conditions of high pressure and/or temperature.
5. Chemicals must be stored away from heat, protected from temperature extremes and powders kept dry. Normal safe handling procedures must be used.
6. When disposing of chemicals ensure that no two chemicals are mixed.

Safety advice concerning the use of the equipment described in this manual or any relevant hazard data sheets (where applicable) may be obtained from the Company address on the back cover, together with servicing and spares information.

CONTENTS

1	INTRODUCTION	2
1.1	Purpose	2
1.2	Systems and Cartridges	2
2	INSTALLATION	3
2.1	Typical Installation	3
2.2	Water Supply for Water Wash Systems	3
2.3	Fitting the Dissolved Oxygen Sensor	4
2.4	Installing the Cartridge	4
3	CALIBRATION	5
4	MAINTENANCE	6
4.1	General Cleaning	6
4.2	Calibration Requirement	6
4.3	Replacing the Oxygen Sensor	6
5	SPARES	7
6	SPECIFICATION	8

1 INTRODUCTION

1.1 Purpose – Fig. 1.1

This instruction manual describes the installation and maintenance of the 9408-8000 Series Dissolved Oxygen System.

1.2 Systems and Cartridges – Fig. 1.1

Systems comprise a cartridge and a 'T' piece flowcell with connection fittings. The table below summarizes the available combinations of pipe size/connection type, cable length and cleaning option. Part numbers for individual items are listed in the Spares Section.

Dissolved Oxygen System	9408/8	X	X	X
Process connections				
1" BSP		0		
1/2" BSP		1		
1" NPT		2		
1/2" NPT		3		
Cable length in metres				
1			0	
3			1	
5			2	
10			3	
20			4	
Cleaning				
Without cleaning				0
With cleaning				2

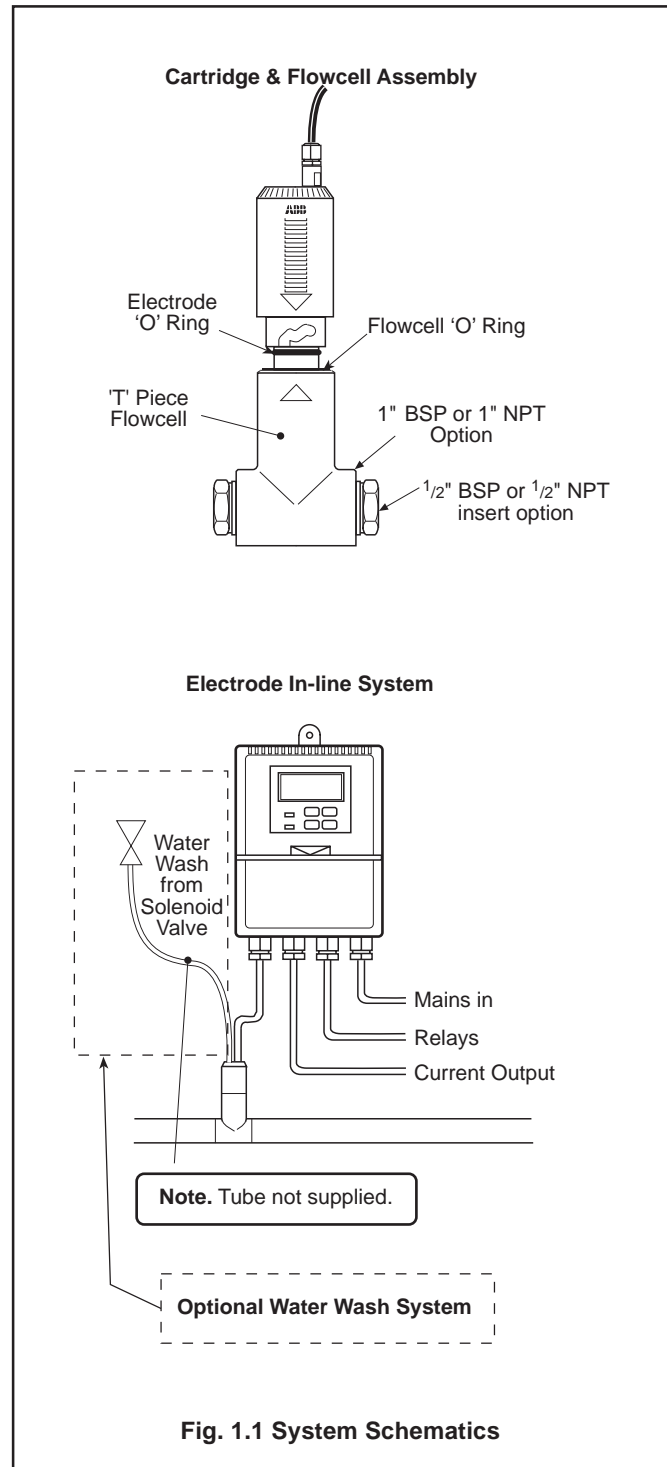

2 INSTALLATION

2.1 Typical Installation

A typical installation is shown in Fig. 2.1. A recommended installation for samples which may have entrained air or are subject to intermittent flow is shown in Fig. 2.2

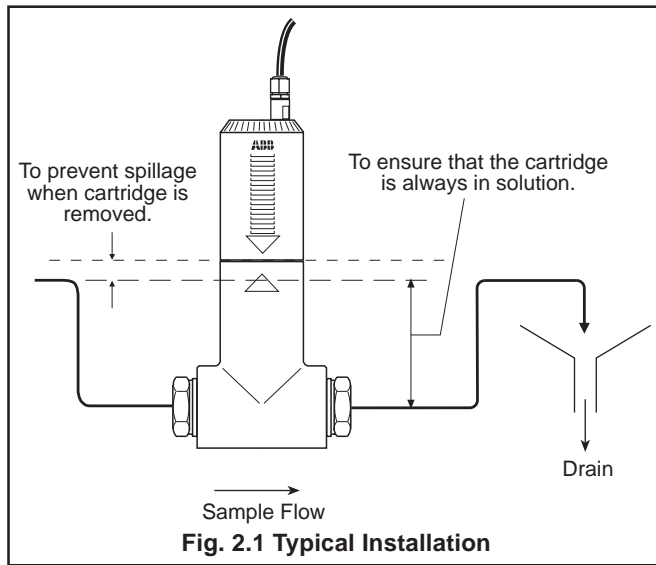

2.2 Water Supply for Water Wash Systems – Fig. 2.3 and 2.4

Important Note. Installation must only be carried out in accordance with the local water authority and council bylaws.

Caution. The maximum water pressure at the electrode should not exceed 4 bar. At NO time should the sample pressure be allowed to exceed that of the Water Wash water supply. Fit a non return valve if this possibility exists.

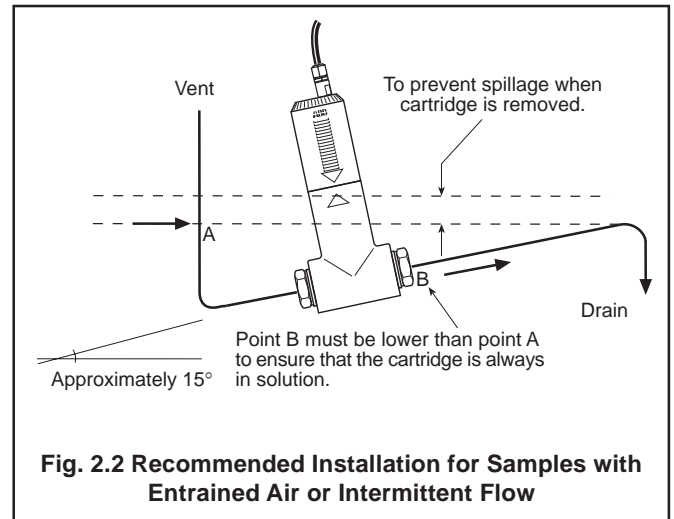
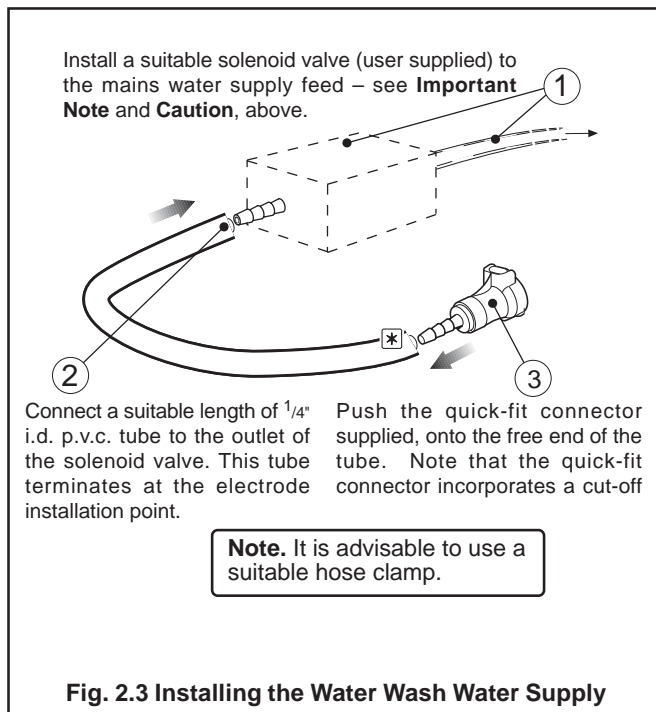

Information. As all quick-fit connectors used in Water Wash systems incorporate cutoff valves, tubes may subsequently be disconnected on operational equipment without sample loss or Water Wash discharge.

Note. For optimum performance of the Water Wash function in flow systems, the sample pressure should be at least 2 bars lower than that of the Water Wash water supply.

The water supply for the Water Wash system must come from a suitable supply via a solenoid valve. The general specification for the solenoid valve is:

Brass body: 2/2, NC
 Orifice size: 3.0 / 4.0 mm
 Port size: 1/8" – 1/4" BSP
 Pressure: 0 to 6 bar
 Coil: 110/115 V a.c. or 230/240 V a.c. 50/60 Hz

Before fitting the electrode cartridge system, install the water supply as shown in Fig. 2.3.

Note. See Fig. 2.3 for recommended tubing.

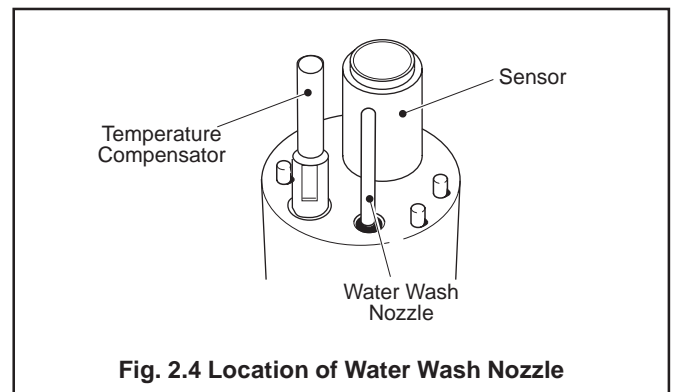

...2 INSTALLATION

2.3 Fitting the Dissolved Oxygen Sensor – Fig. 2.5

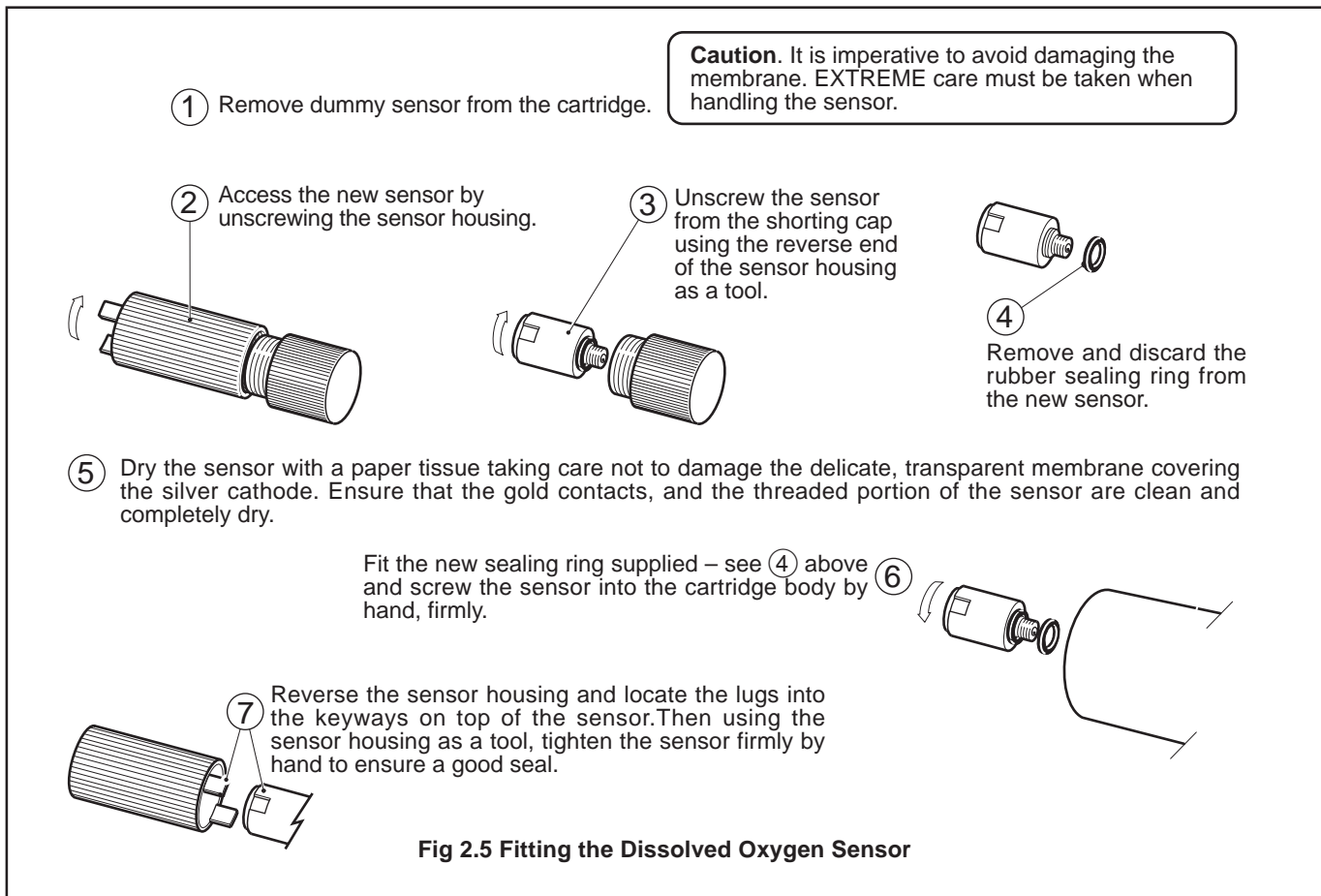

2.4 Installing the Cartridge

- a) Fit the flowcell into the pipeline observing all safety precautions. Fit isolating valves where necessary to enable safe access to the sensor for maintenance purposes.
- b) Ensure that all connections are tight.
- c) Connect the end of the cable from the cartridge to the 4600 Series Transmitter – see Tables 2.1 and 2.2 and the appropriate 4600 Series manual.

Table 2.1 Connections to the 4645 Dissolved Oxygen Transmitter

4645		
TBB		
	Terminal No.	Wire
Temperature Compensator	6	yellow
	6	green
	8	black
Sensor	10	-ve (blue)
	11	
	12	+ve (red)

Connect the screen to the earth stud on the case.

Table 2.1 Connections to the 4640 Dissolved Oxygen Transmitter

4640		
	Terminal No.	Wire
Sensor	1	+ve (red)
	2	
	3	-ve (blue)
	4	screen
Temperature Compensator	5	black
	6	green
	7	yellow

- f) Calibrate – see Section 3.
- g) For Water Wash systems, snap on the water feed pipe from the solenoid valve – see Fig. 2.6.
- h) Visually check water cleaning action by switching on the Water Wash option on the 4600 transmitter. There should be a vigorous jet of water sprayed across or onto the sensor membrane.

2 INSTALLATION

- i) Ensure that all pipeline connections are securely fitted. Apply PTFE tape to the threads of the 1" NPT cartridge to effect a water tight seal, and check that the 'O' ring and sealing area are clean on bayonet.
- j) Fit the electrode cartridge to the flowcell.

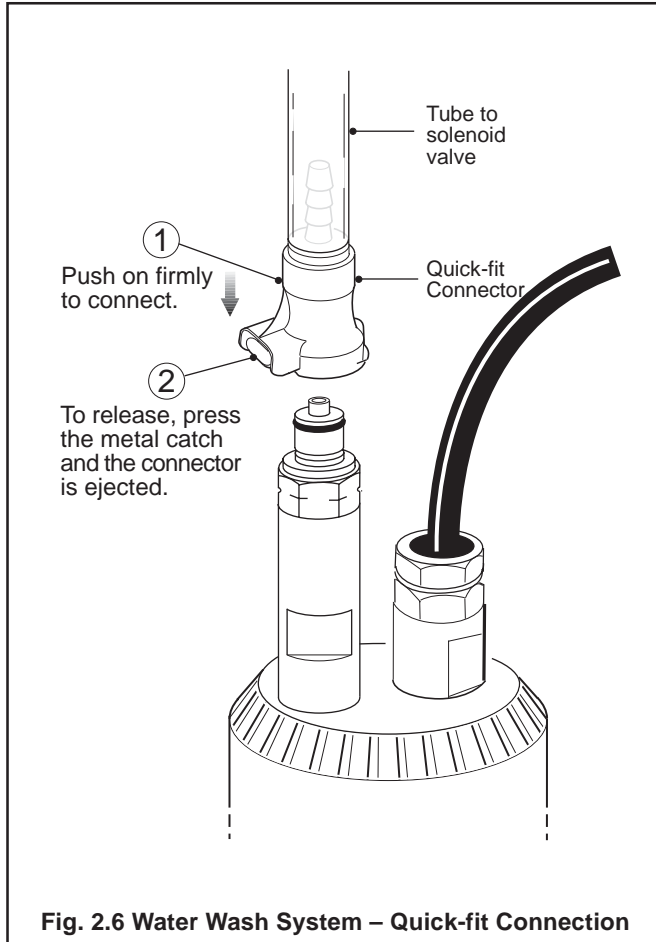

3 CALIBRATION

The procedures for zero and span calibration are fully described in the 4600 Series Transmitter Operating Instructions to which reference should be made.

Note. It is advisable to switch off the Water Wash before starting the calibration procedure. This can be done either by turning off at the transmitter unit, or by disconnecting the quick-fit connector.

- 1) Isolate the flowcell.
- 2) Remove the system from its mounting bracket.

Caution. It is imperative to avoid damaging the membrane when removing the cartridge (with sensor) from the flowcell. Use EXTREME care in step 3).

- 3) Remove the cartridge from the flowcell.
- 4) Wash the exposed sensor capsule CAREFULLY with clean water.
- 5) Calibrate as instructed in the 4600 Series Transmitter Operating Instructions.
- 6) Re-enable the Water Wash (if applicable).
- 7) Again, use EXTREME care when fitting the cartridge into the flowcell to avoid damaging the membrane; remount on the bracket and restore the sample.

4 MAINTENANCE

Regular maintenance is limited to periodic cleaning and calibration.

4.1 General Cleaning

To ensure accurate monitoring, the sensor membrane must be kept clean by periodic washing. The frequency depends on the particular application.

Caution. It is imperative to avoid damaging the membrane. EXTREME care must be taken when handling the sensor.

Wash the membrane using clean water and a soft cloth or tissue.

4.2 Calibration Requirement

Regular calibrations keep the system operating at the optimum level. Calibration also gives an early indication of degrading sensor performance. See Section 3 for the calibration procedure.

4.3 Replacing the Oxygen Sensor

The sensor is replaced whenever the existing one becomes exhausted. Typical sensor life is approximately 12 months.

Storage

DO:

- use sensors in date rotation to prevent them being stored longer than necessary.
- at all times, store sensors in a dry and cool environment.
- store sensors in a refrigerator to extend their life, but DO NOT allow them to freeze.

DO NOT:

- allow sensors to dry out, either in storage or in use.
- leave sensors in vehicles where they are likely to freeze or be exposed to high temperatures.
- leave sensors on-site without protection from direct sun or high temperatures.
- use the sensor if it's sealed environment has dried out.

- 1 Isolate and remove the cartridge from the flowcell.

Caution. Clean and dry the area around the sensor capsule before removal, as indicated below.

- 2 Use the sensor housing as a tool to unscrew the old sensor from the cartridge body (see 9 for method); discard the old capsule in accordance with local regulations.
- 3 Dry the cartridge body with a paper tissue; ensure that the gold electrical contacts, and the recess into which the capsule screws, are clean and completely dry.

Caution.

- Do not leave the new sensor exposed to air for more than 30 minutes as the membrane will dry out.
- Ensure the following steps are done carefully to avoid damaging the membrane covering the silver cathode.

- 4 Access the new capsule by unscrewing the capsule housing
- 5 Unscrew the capsule from the shorting cap using the reverse end of the capsule housing as a tool.
- 6 Remove and discard the rubber sealing ring from the new capsule.
- 7 Dry the sensor with a paper tissue taking care not to damage the delicate, transparent membrane covering the silver cathode. Ensure that the gold contacts, and the threaded portion of the sensor are clean and completely dry.
- 8 Fit the new sealing ring supplied – see 6 above and screw the sensor into the cartridge body by hand.
- 9 Reverse the sensor housing and locate the lugs into the keyways on top of the sensor. Then using the sensor housing as a tool, tighten the sensor firmly by hand to ensure a good seal.
- 10 Calibrate the cartridge – see Section 3.
- 11 Finish the installation – see Section 2.4.

Fig. 4.1 Procedure for Changing the Sensor Capsule

5 SPARES

Dissolved Oxygen Sensor 8012 170

Cartridges

D.O. cartridge, 1 m cable 9408 800
D.O. cartridge, 3 m cable 9408 801
D.O. cartridge, 5 m cable 9408 802
D.O. cartridge, 10 m cable 9408 803
D.O. cartridge, 20 m cable 9408 804
D.O. cartridge, special cable length 9408 809

Cartridges + Water Wash

D.O. cartridge, 1 m cable 9408 810
D.O. cartridge, 3 m cable 9408 811
D.O. cartridge, 5 m cable 9408 812
D.O. cartridge, 10 m cable 9408 813
D.O. cartridge, 20 m cable 9408 814
D.O. cartridge, special cable length 9408 819

Additional Spares for Water Wash systems only

End Cap Quick-fit in-line connector – 1/4" barb 0216512
End Cap Quick-fit connector insert –
panel mount 1/8" hose barb 0216513
Cartridge Quick-fit in-line connector – 1/8" barb 0216514
Tubing – specify length: 1, 2, 3, 5, 10, 20 metres or
special length 0212141
Hose clamp for tubing above 0215163

6 SPECIFICATION

Materials of construction	Glass-coupled polypropylene
Operating temperature range	-5°C to 40°C
Operating pressure	Atmospheric
Temperature compensation	Automatic correction by means of an integral Pt100 resistance sensor
Accuracy	±0.2 mg/l or ±2% saturation within ±10°C of the calibration temperature within the range 0°C to 35°C
Response	Typically 20 seconds for 90% step change of oxygen concentration at 20°C
Pressure rating	2 bar
Flow rate	2 litres a minute minimum
Process connections	1/2" and 1" BSP and 1/2" and 1" NPT
Cable lengths	1, 3, 5, 10 and 20 metre (standard options). With a suitable junction box fitted, a maximum 100 metre cable can be used – part number 0233 828.

PRODUCTS & CUSTOMER SUPPORT

Products

Automation Systems

- *for the following industries:*
 - Chemical & Pharmaceutical
 - Food & Beverage
 - Manufacturing
 - Metals and Minerals
 - Oil, Gas & Petrochemical
 - Pulp and Paper

Drives and Motors

- *AC and DC Drives, AC and DC Machines, AC Motors to 1kV*
- *Drive Systems*
- *Force Measurement*
- *Servo Drives*

Controllers & Recorders

- *Single and Multi-loop Controllers*
- *Circular Chart and Strip Chart Recorders*
- *Paperless Recorders*
- *Process Indicators*

Flexible Automation

- *Industrial Robots and Robot Systems*

Flow Measurement

- *Electromagnetic Flowmeters*
- *Mass Flow Meters*
- *Turbine Flowmeters*
- *Flow Elements*

Marine Systems & Turbochargers

- *Electrical Systems*
- *Marine Equipment*
- *Offshore Retrofit and Refurbishment*

Process Analytics

- *Process Gas Analysis*
- *Systems Integration*

Transmitters

- *Pressure*
- *Temperature*
- *Level*
- *Interface Modules*

Valves, Actuators and Positioners

- *Control Valves*
- *Actuators*
- *Positioners*

Water, Gas & Industrial Analytics Instrumentation

- *pH, Conductivity and Dissolved Oxygen Transmitters and Sensors*
- *Ammonia, Nitrate, Phosphate, Silica, Sodium, Chloride, Fluoride, Dissolved Oxygen and Hydrazine Analyzers*
- *Zirconia Oxygen Analyzers, Katharometers, Hydrogen Purity and Purge-gas Monitors, Thermal Conductivity*

Customer Support

We provide a comprehensive after sales service via a Worldwide Service Organization. Contact one of the following offices for details on your nearest Service and Repair Centre.

United Kingdom

ABB Limited
Tel: +44 (0)1453 826661
Fax: +44 (0)1453 829671

United States of America

ABB Inc.
Tel: +1 (0) 775 850 4800
Fax: +1 (0) 775 850 4808

Client Warranty

Prior to installation, the equipment referred to in this manual must be stored in a clean, dry environment, in accordance with the Company's published specification.

Periodic checks must be made on the equipment's condition. In the event of a failure under warranty, the following documentation must be provided as substantiation:

1. A listing evidencing process operation and alarm logs at time of failure.
2. Copies of all storage, installation, operating and maintenance records relating to the alleged faulty unit.

ABB has Sales & Customer Support
expertise in over 100 countries worldwide

www.abb.com

The Company's policy is one of continuous product
improvement and the right is reserved to modify the
information contained herein without notice.

Printed in UK (05.05)

© ABB 2005



ABB Limited
Oldends Lane, Stonehouse
Gloucestershire
GL10 3TA
UK
Tel: +44 (0)1453 826661
Fax: +44 (0)1453 829671

ABB Inc.
Analytical Instruments
9716 S. Virginia St., Ste. E
Reno, Nevada 89521
USA
Tel: +1 (0) 775 850 4800
Fax: +1 (0) 775 850 4808