











# Electrical Safety

This equipment complies with the requirements of CEI/IEC 61010-1:2001-2 "Safety requirements for electrical equipment for measurement, control, and laboratory use". If the equipment is used in a manner NOT specified by the Company, the protection provided by the equipment may be impaired.

## Symbols

One or more of the following symbols may appear on the equipment labelling:

	<b>Warning</b> – Refer to the manual for instructions
	<b>Caution</b> – Risk of electric shock
	Protective earth (ground) terminal
	Earth (ground) terminal

	Direct current supply only
	Alternating current supply only
	Both direct and alternating current supply
	The equipment is protected through double insulation

Information in this manual is intended only to assist our customers in the efficient operation of our equipment. Use of this manual for any other purpose is specifically prohibited and its contents are not to be reproduced in full or part without prior approval of the Technical Communications Department.

### Health and Safety

To ensure that our products are safe and without risk to health, the following points must be noted:

1. The relevant sections of these instructions must be read carefully before proceeding.
2. Warning labels on containers and packages must be observed.
3. Installation, operation, maintenance and servicing must only be carried out by suitably trained personnel and in accordance with the information given.
4. Normal safety precautions must be taken to avoid the possibility of an accident occurring when operating in conditions of high pressure and/or temperature.
5. Chemicals must be stored away from heat, protected from temperature extremes and powders kept dry. Normal safe handling procedures must be used.
6. When disposing of chemicals ensure that no two chemicals are mixed.

Safety advice concerning the use of the equipment described in this manual or any relevant hazard data sheets (where applicable) may be obtained from the Company address on the back cover, together with servicing and spares information.

---

# GETTING STARTED

---

The COMMANDER 160 is a development of the COMMANDER 150 1/8 DIN indicator and uses the same programming procedures. It also compliments the COMMANDER 310 universal controller giving an IP66 indicator in the same case, providing a retransmission output and three alarm relays, with the option to add MODBUS™ RS485 communications.

This manual is divided into 5 sections which contain all the information needed to install, configure, commission and operate the COMMANDER 160. Each section is identified clearly by a symbol as shown below.



## Displays and Controls

- Displays and function keys
- LED Indication
- Error Messages



## Operator Mode (Level 1)

- Operator menus for:
  - *Standard Indicator*
  - *Totalizer/Batch Controller*
  - *Maximum/Minimum/Average Indicator*



## Set Up Mode (Level 2)

- Alarm trip points
- Totalizer functions



## Configuration Mode (Levels 3 and 4)

- Accessing the configuration levels
- Level 3
  - Hardware assignment and input type
  - Alarm types and hysteresis
  - Operator functions and totalizer setup
  - Digital input and serial communications
- Level 4
  - Ranges and passwords



## Installation

- Siting
- Mounting
- Electrical connections

### Symbol Identification and Section Contents

---

# CONTENTS

---

Section	Page
<b>GETTING STARTED</b> .....	<b>1</b>
<b>1 DISPLAYS AND FUNCTION KEYS</b> .....	<b>3</b>
1.1 Introduction .....	3
1.2 Use of Function Keys .....	4
1.3 LED Alarms and Indicators .....	5
1.4 Error Messages .....	6
<b>2 OPERATOR MODE</b> .....	<b>7</b>
2.1 Introduction .....	7
2.2 Operating Page – Standard .....	8
2.3 Operating Page – Totalizer .....	9
2.4 Operating Page – Math Functions .....	11
<b>3 SET UP MODE</b> .....	<b>13</b>
3.1 Introduction .....	13
3.2 Set Up Level .....	14
<b>4 CONFIGURATION MODE</b> .....	<b>18</b>
4.1 Introduction .....	18
4.2 Accessing the Configuration Mode .....	18
4.3 Basic Configuration .....	20
4.3.1 Hardware Assignment and Input Type .....	20
4.3.2 Alarms .....	22
4.3.3 Operator Functions and Totalizer Set Up .....	26
4.3.4 Digital Input and Serial Communications .....	28
4.4 Ranges and Passwords .....	30
<b>5 INSTALLATION</b> .....	<b>33</b>
5.1 Siting .....	33
5.2 Mounting .....	35
5.3 Cable Glands and Conduit Fixings .....	37
5.3.1 Cable Glands (IEC – 20mm) .....	37
5.3.2 Conduit Adapters (N. American – 0.5 in.) .....	37
5.3.3 Cable Glands (N. American – 0.5 in.) .....	38
5.4 Electrical Connections .....	39
<b>6 SPECIFICATION</b> .....	<b>41</b>

# 1 DISPLAYS AND FUNCTION KEYS

## Information.

The fold-out page inside on the back cover of this manual shows all the frames in the programming levels. Space is provided on the page for writing the programmed setting or selection for each frame.

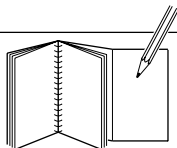

## 1.1 Introduction – Fig. 1.1

The COMMANDER 160 front panel display, function keys and LED indicators are shown in Fig. 1.1.

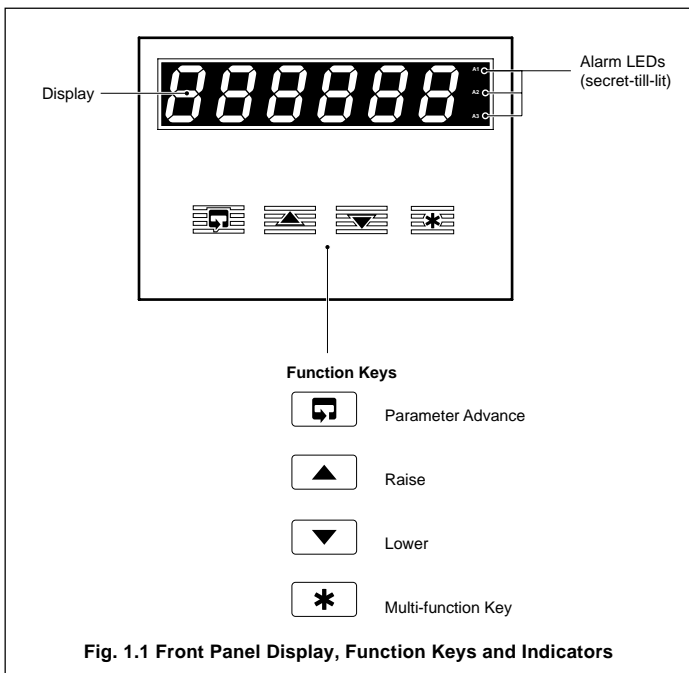

## 1.2 Use of Function Keys – Fig. 1.2

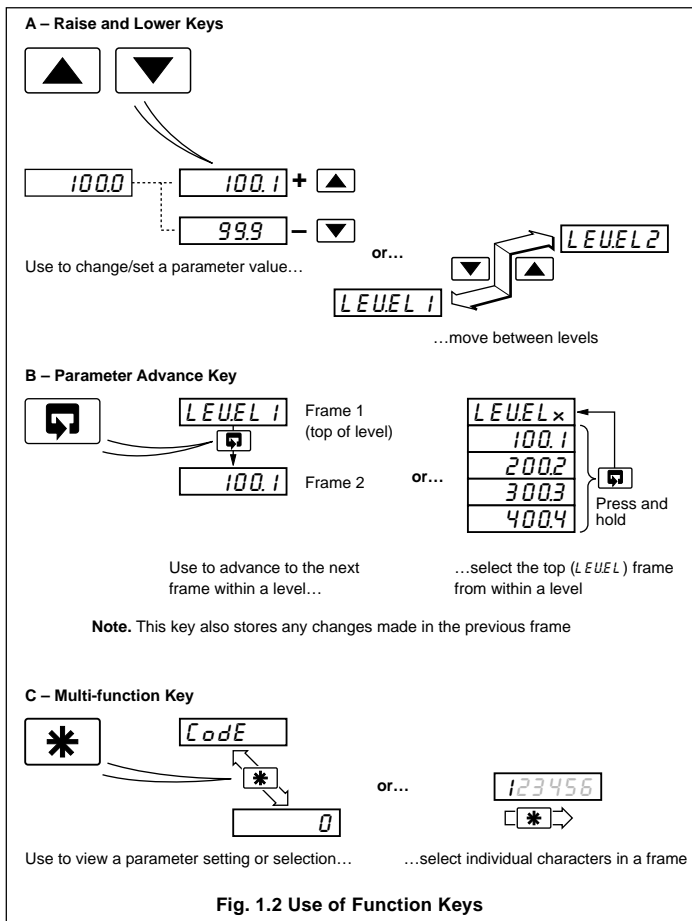
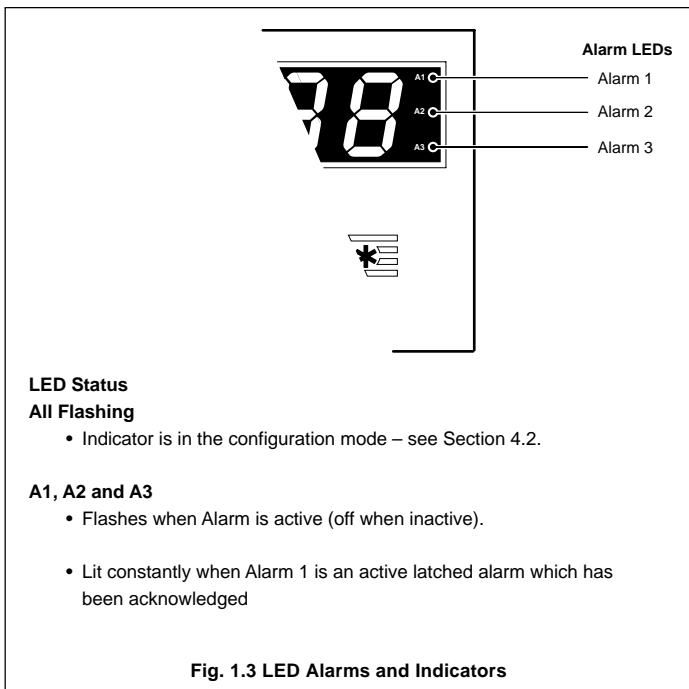
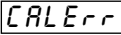

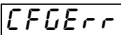

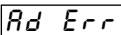
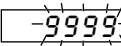
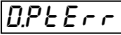

Fig. 1.2 Use of Function Keys

### 1.3 LED Alarms and Indicators



## 1.4 Error Messages

Display	Error/Action	To Clear Display
	<b>Calibration error</b> Turn mains power off and on again (if the error persists contact the Service Organization).	Press the  key
	<b>Configuration error</b> The configuration and/or setup data for the instrument is corrupted. Turn mains power off and on again (if error persists, check configuration/setup settings).	Press the  key
	<b>A to D Converter fault</b> The analog to digital converter is not communicating correctly.	Turn mains power off and on again. If the error persists, contact the Service Organization
	<b>Process variable over/under range</b>	Restore valid input
	<b>Option board error</b> Communications to the option board have failed.	Contact the Service Organization



## 2 OPERATOR MODE

### 2.1 Introduction

Operator Mode (Level 1) is the normal day-to-day mode of the COMMANDER 160.

Frames displayed in level 1 are determined by the indicator functions which are selected during configuration of the instrument – see Section 4.

**Note.** Only the operating frames relevant to the configured functions are displayed in Operator Mode.

The three indicator functions are:

- **Standard Indicator** – page 8
- **Indicator with Totalization** – page 9
- **Indicator with Max./Min./Average** – page 11



### 2.2 Operating Page – Standard (Level 1)

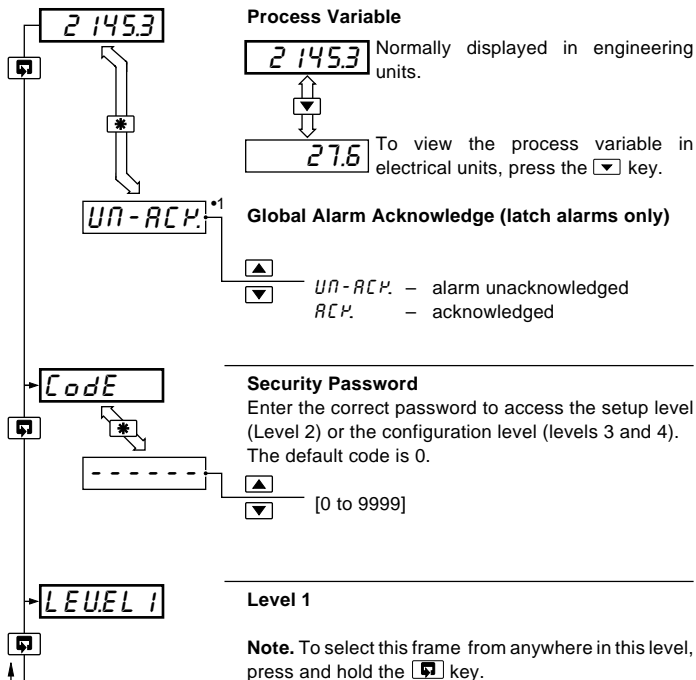

•1 Displayed only if there is an active latch alarm.



## 2.3 Operating Page – Totalizer (Level 1)

These frames are displayed only if the totalizer function is enabled in the configuration level – see Section 4.3.3

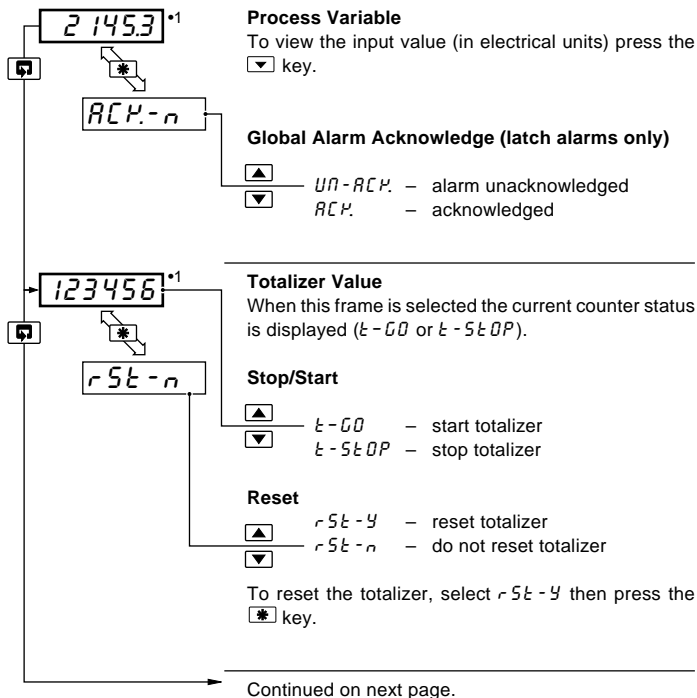

- 1 Totalizer stop/go and reset from these frames can be disabled – see Section 4.3.3.

A digital input can also be used to start/stop or reset the totalizer – see Section 4.3.4



### ...2.3 Operating Page – Totalizer (Level 1)

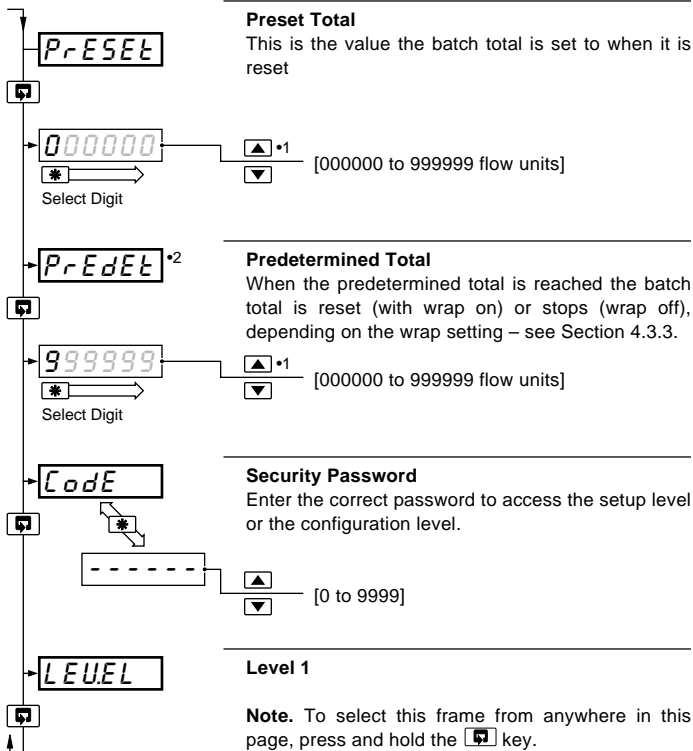

- 1 The predetermined value should be greater than the preset value when the totalizer is counting up and lower than the preset value when the totalizer is counting down.
- 2 Displayed only if enabled in the configuration level – see Section 4.3.3.



## 2.4 Operating Page – Math Functions (Level 1)

**Note.** It is possible to display totalizer and math functions together.

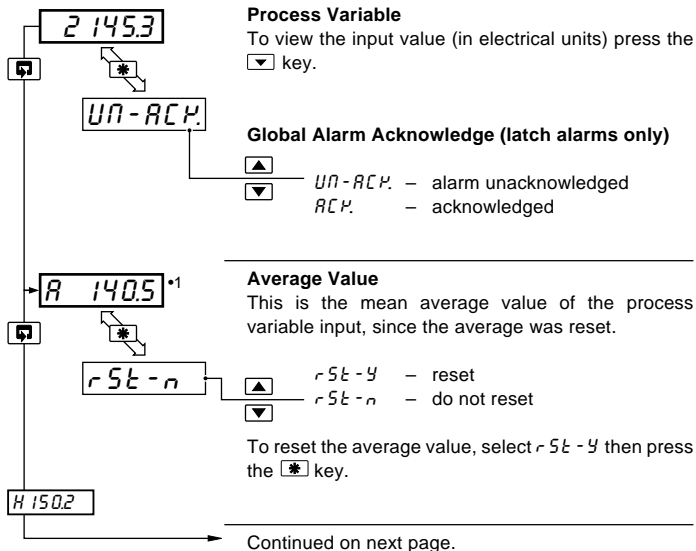

- 1 This frame can be disabled – see Section 4.3.3.

The reset function in this frame can be disabled – see Section 4.3.3.

The average value is reset automatically on power-up and can also be reset from a digital input – see Section 4.3.4.



### ...2.4 Operating Page – Math Functions (Level 1)

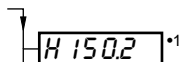

#### Maximum Value

This is the maximum value of the process variable since the maximum was reset.

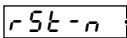

- rSt-y – reset
- rSt-n – do not reset

To reset the maximum value, select rSt-y then press the key.

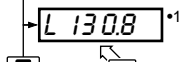

#### Minimum Value

This is the minimum value of the process variable since the minimum was reset.

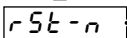

- rSt-y – reset
- rSt-n – do not reset

To reset the minimum value, select rSt-y then press the key.

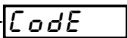

#### Security Code

Enter the correct code to access the setup level or the configuration level.

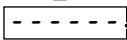

- [0 to 9999]
- 

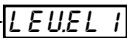

#### Level 1

**Note.** To select this frame from anywhere in this page, press and hold the key.

•1 This frame can be disabled – see Section 4.3.3.

The reset function in this frame can be disabled – see Section 4.3.3.

The average value is reset automatically on power-up and can also be reset from a digital input – see Section 4.3.4.

## 3 SET UP MODE

### 3.1 Introduction

To access the Set Up Level (Level 2) the correct set up or configuration level password must be entered in the security password frame (*Code*) in Level 1 – see Sections 2.2 to 2.4.

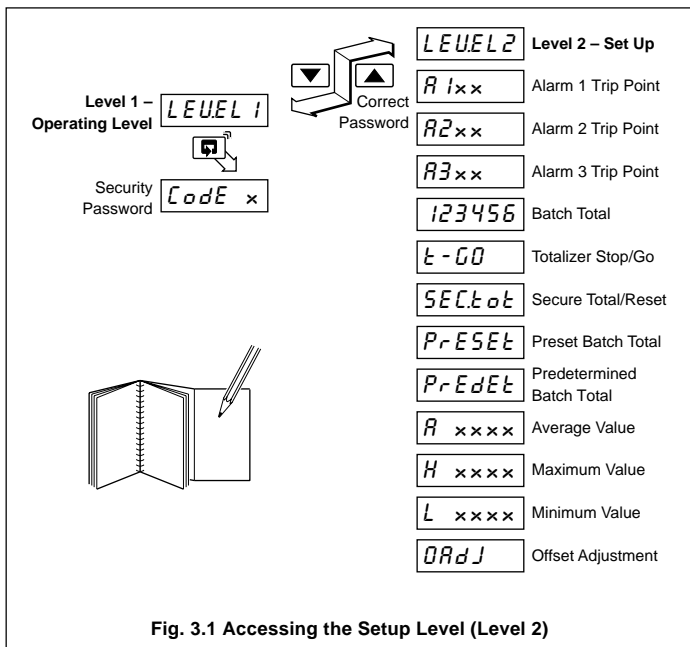



## 3.2 Set Up Level (Level 2)

## Level 2

**Note.** To select this frame from anywhere in this level, press and hold the  key.

## Alarm 1 Trip Point

Alarm type: *R ihP* = High process  
*R ilP* = Low process  
*R iHL* = Latched high process  
*R iLL* = Latched low process  
*R iFr* = Fast Rate  
*R iSr* = Slow Rate

 Process and Latched Alarms in Eng. units.  
 Rate Alarms  $\pm 0.5$  to 500% of Eng. Span/hr.

## Alarm 1 Hysteresis Value



 [In engineering units]  

## Alarm 2 Trip Point

Alarm type

 [In engineering units]  

## Alarm 2 Hysteresis Value

 [In engineering units]  

Continued on next page.

- 1 Not displayed if the alarm is disabled ('None' selected) – see Section 4.3.2.
- 2 Displayed only if custom alarm hysteresis is selected – see Section 4.3.2  
 Not displayed if 'Rate' Alarm type is selected.



### ...3.2 Setup Level (Level 2)

**A3hP**\*1 **Alarm 3 Trip Point**  
Alarm type

[▲] [▼] [In engineering units]

**3003**

---

**A3 HYS**\*2 **Alarm 3 Hysteresis Value**  
[In engineering units]

[▲] [▼]

**34.6**

---

**123456**\*3 **Totalizer Value**

[▲] *rSt-y* – reset  
[▼] *rSt-n* – do not reset

To reset the maximum value, select *rSt-y* then press the **\***  key.

---

**t-GO**\*3 **Totalizer Stop/Go**

[▲] *t-GO* – start totalizer  
[▼] *t-StOP* – stop totalizer

Setting to *t-GO* starts the totalizer counting towards the predetermined value. Setting to *t-StOP* holds the totalizer at its present value.

**SEtSt**

Continued on next page

- 1 Not displayed if the alarm is disabled ('NONE' selected) – see Section 4.3.2
- 2 Displayed only if custom alarm hysteresis is selected – see Section 4.3.2  
Not displayed if 'Rate' Alarm type is selected.
- 3 Displayed only if enabled in the Configuration Level – see Section 4.3.3
- 4 A digital input can also be used to reset the batch total.

## ...3.2 Set Up Level (Level 2)

**SECT00**<sup>\*1</sup>

**Secure Total**  
The secure total is independent of the batch total value. When 999999 or 000000 is reached, the total is reset and then continues counting.

**456789** — **Total**

**Reset**

**r5t-n** ▲ r5t-y — reset totalizer  
▼ r5t-n — do not reset totalizer

To reset, select r5t-y then press the [\*] key.

---

**PrESEt**<sup>\*2</sup>

**Preset Batch Total**  
This is the value the batch total is set to when it is reset.

▲ [000000 to 999999]  
▼

---

**PrEdEt**<sup>\*2</sup>

**Predetermined Batch Total**  
When this value is reached the batch total either resets (with wrap on) or stops (wrap off) – see Section 4.3.3.

▲ [000000 to 999999]  
▼

**R 140.5**

Continued on next page.

- 1 Displayed only if enabled in the Configuration Level – see Section 4.3.3.
- 2 The preset value must be lower than the predetermined value when counting up, and greater than the predetermined value when counting down.



### ...3.2 Set Up Level (Level 2)

---

**Average Value**  
 This is the mean average value of the process variable input since the average was reset.

<sup>\*1</sup>

$rSt - n$

▲  $rSt - y$  – reset  
 ▼  $rSt - n$  – do not reset

To reset, select  $rSt - y$  then press the key.

---

**Maximum Value**  
 This is the maximum value of the process variable since the maximum was reset.

<sup>\*2</sup>

$rSt - n$

▲  $rSt - y$  – reset  
 ▼  $rSt - n$  – do not reset

To reset, select  $rSt - y$  then press the key.

---

**Minimum Value**  
 This is the minimum value of the process variable since the minimum was reset.

<sup>\*2</sup>

$rSt - n$

▲  $rSt - y$  – reset  
 ▼  $rSt - n$  – do not reset

To reset, select  $rSt - y$  then press the key.

---

**Offset Adjustment**  
 An offset can be applied to the process variable input to enable spot calibration or the removal of system errors.

$OffJ$

$1.0$

▲ [±10% of engineering range]  
 ▼

---

- 1 The average value is reset automatically on power-up and can also be reset from a digital input – see Section 4.3.4.
- 2 The maximum and minimum values are reset automatically on power-up and can also be reset from a digital input – see Section 4.3.4.



## 4 CONFIGURATION MODE

### 4.1 Introduction

The Configuration Mode comprises two levels (3 and 4) as shown in Fig. 4.2.

Configuration level 3 is divided into four frames. For most simple applications it is only necessary to set up the parameters in the first frame.

#### Note.

When in the configuration level:

- All the l.e.d. indicators flash.
- All relays and logic outputs are turned off.
- The analog output reverts to 0% (4mA) output level.

### 4.2 Accessing the Configuration Mode – Fig. 4.1

The Configuration Mode is accessed by entering the correct password in level 1 (see Sections 2.2 to 2.4). The configuration password is set up in level 4.

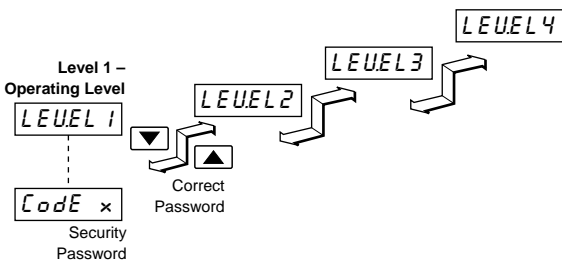
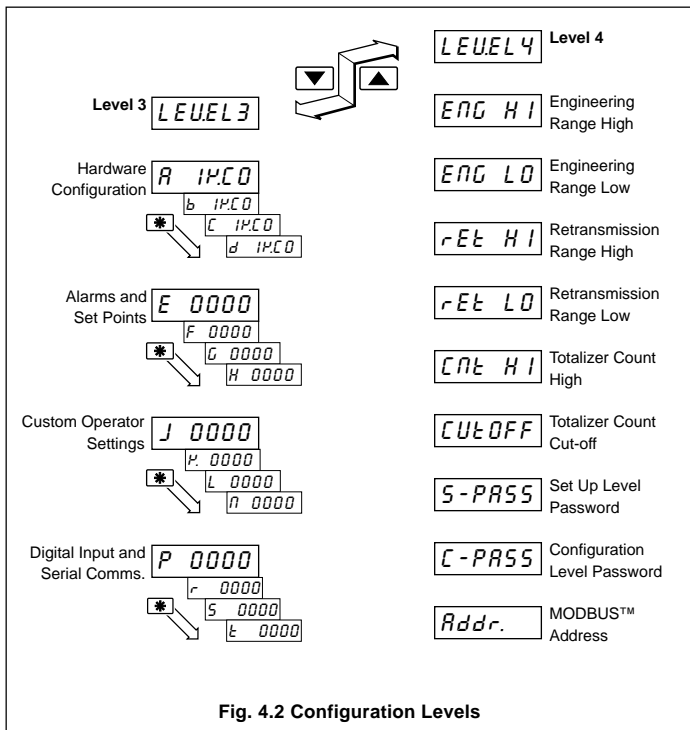

Fig. 4.1 Accessing the Configuration Level (Levels 3 and 4)





### 4.3 Basic Configuration (Level 3) – Fig. 4.3

#### 4.3.1 Hardware Assignment and Input Type

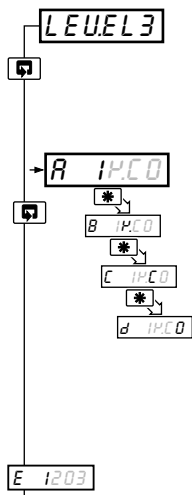

#### Level 3

**Note.** To select this frame from anywhere in this level, press and hold the  key for a few seconds.

#### 'RbCd' Settings

The first character (*R*, *b*, *C* or *d*) identifies the parameter to be changed. The current setting is indicated by a flashing letter. Parameter options are shown in Fig. 4.3.

- R* = Hardware configuration
- b* = Input type and range
- C* = Temperature units
- d* = No. of decimal points

**Note.** For custom settings contact the local distributor.

Continued on page 22.

#### Information.

##### Count High Calculation

Convert flow rate into units/sec =  $\frac{\text{actual engineering flow rate}}{\text{flow range time units (in seconds)}}$

Count High =  $\frac{\text{units/sec}}{\text{counter factor}}$  resultant must be >0.001 and <99.999pps.

Counter factor is the engineering value of the least significant digit shown on the totalizer display – see Section 4.3.3.

##### Totalizer Count Pulse

The totalizer count pulse is on for a preset time of 250ms and off for a minimum of 250ms.

**R 1P.C0** A – Hardware Configuration

Supply Hz		Relay 1 Source	Relay 2 Source	Relay 3* Source	Logic O/P Source	Analog O/P Source
50	60					
1	R	Alarm 1	Alarm 2	Alarm 3	TCP**	PV
2	b	Alarm 1	Alarm 2	Alarm 3	TWP**	PV
3	c	TCP**	Alarm 1	Alarm 2	TWP**	PV
4	d	TWP**	Alarm 1	Alarm 2	TCP**	PV
5	E	Alarm 1	Alarm 2	Alarm 3	TCP**	PV Average
U		Custom	Custom	Custom	Custom	Custom

TCP = Totalizer Count Pulse    TWP = Totalizer Wrap Pulse    PV = Process Variable

\* Not available if MODBUS™ option fitted.

\*\* Pulse energizes assigned relay

**b 1P.C0** B – Input Type and Range Configuration

Display		Display	
b	THC Type B	1	0 to 20 mA
E	THC Type E	2	4 to 20 mA
J	THC Type J	3	0 to 5 V
K	THC Type K	4	1 to 5 V
N	THC Type N	6	0 to 50 mV
R	THC Type R	7	4 to 20 mA (square root linearizer)
S	THC Type S	U	Custom Configuration
T	THC Type T		
P	PT100 RTD		

**C 1P.C0** C – Temperature Units

Display	Temperature Units
C	Degrees C*
F	Degrees F*
0	No temperature units

\* Temperature inputs only

**d 1P.C0** D – Process Variable Display Decimal Places

Display	
0	xxxx
1	xxx . x
2	xx . xx
3	x . xxx
4	x . xxxx

**Fig. 4.3 Hardware Configuration and Input/Output Ranges**



### 4.3.2 Alarms – Figs. 4.4, 4.5 and 4.6

**Note.** All relays are de-energized in the alarm state.

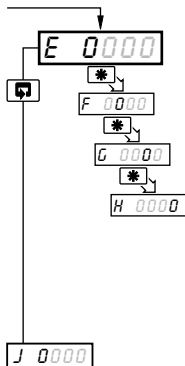

---

#### 'EFGH' Settings

The first character (*E*, *F*, *G* or *H*) identifies the parameter to be changed. The current setting is indicated by a flashing letter. Parameter options are shown in Fig. 4.4.

- E* = Alarm 1 type
- F* = Alarm 2 type
- G* = Alarm 3 type
- H* = Alarm hysteresis

**Note.** For custom settings contact the local distributor.

---

Continued on page 26.



**E 0000** E – Alarm 1 Type

Display	
0	None
1	High Process
2	Low Process
3	High Latch
4	Low Latch
5	Fast Rate
6	Slow Rate

**F 0000** F – Alarm 2 Type

Display	
0	None
1	High Process
2	Low Process
3	High Latch
4	Low Latch
5	Fast Rate
6	Slow Rate

**G 0000** G – Alarm 3 Type

Display	
0	None
1	High Process
2	Low Process
3	High Latch
4	Low Latch
5	Fast Rate
6	Slow Rate

**h 0000** H – Alarm Hysteresis

Display	
0	None
1	0.1%
2	0.2%
3	0.5%
4	1.0%
5	2.0%
6	5.0%
U	Custom

} Value in % of engineering range

} Value in engineering units – see Note.

**Note.** When custom alarm hysteresis is selected, the alarm hysteresis values are set individually in the **Set Up Level** – see Section 3.2.

Fig. 4.4 Alarm Setup



### ...4.3.2 Alarms – Figs. 4.4, 4.5 and 4.6

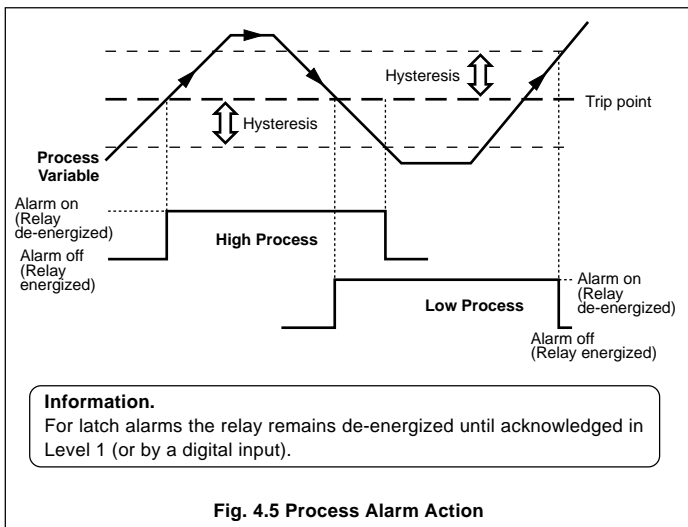

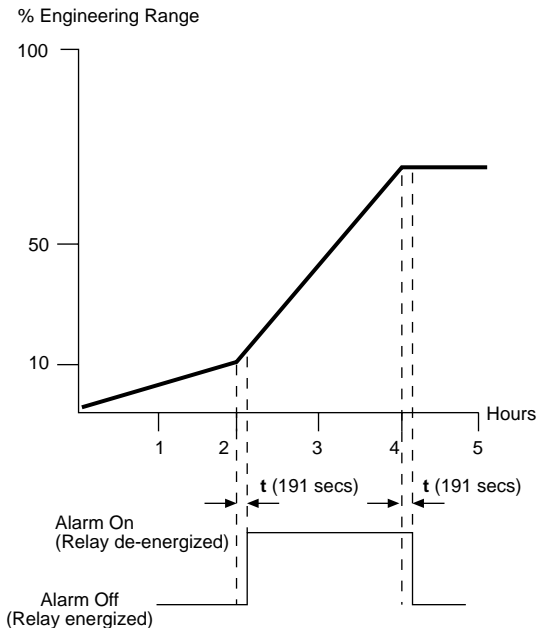

**Information.** The example above shows a fast rate alarm with a trip value of 10% of the Engineering Span per hour on an engineering range of 0.0 to 100.0. The time taken to detect whether an alarm condition is present or has cleared is calculated as follows:

$$t = 10.81 + \frac{1800}{\text{trip value}(10\% \text{ eng span per hour})}$$

$$t = 191 \text{ seconds}$$

**Fig. 4.6 Rate Alarm Action**



### 4.3.3 Operator Functions and Totalizer Set Up – Fig. 4.7

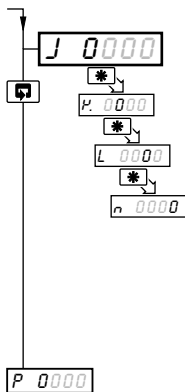

---

#### 'JPLn' Settings

The first character (*J*, *P*, *L* or *n*) identifies the parameter to be changed. The current setting is indicated by a flashing letter. Parameter options are shown in Fig. 4.7.

- J* = Totalizer set-up
- P* = No. of decimal places for totalizer
- L* = Operator level frame enable
- n* = Operator level functions enable/disable

**Note.** For custom settings contact the local distributor.

---

Continued on page 28.



**J 0000** J – Totalizer Setup

Display	
0	Off
1	Count Up, Wrap Off
2	Count Up, Wrap On
3	Count Down, Wrap Off
4	Count Down, Wrap On

**P. 0000** K – Totalizer Display  
Decimal Places

Display	
0	xxxxxx
1	xxxxx.x
2	xxxx.xx
3	xxx.xxx
4	xx.xxxx
5	x.xxxxx

**L 0000** L – Operator Level Frame Enable

Display	Max/Min Values Displayed	Average Value Displayed	Preset/Predetermined Values Displayed
0	No	No	No
1	Yes	No	No
2	Yes	Yes	No
3	No	Yes	Yes
4	No	No	Yes
5	Yes	No	Yes
6	Yes	Yes	Yes

This frame determines which frames appear in the operating page (level 1)

**n 0000** N – Operator Level Math Function & Totalizer Control Enable

Display	Totalizer Stop/Go	Totalizer Reset	Max./Min./Average
0	No	No	No
1	Yes	No	No
2	No	Yes	No
3	Yes	No	Yes
4	No	Yes	Yes
5	Yes	Yes	Yes

This frame determines which functions the operator can control

**Fig. 4.7 Totalizer Setup and Operator Functions**



### 4.3.4 Digital Input and Serial Communications – Figs. 4.8 and 4.9

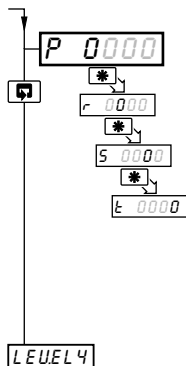

#### 'PrSt' Settings

The first character (*P*, *r*, *S* or *t*) identifies the parameter to be changed and the current setting is indicated by a flashing letter. Parameter options are shown in Fig. 4.9.

- P* = Digital input function
- r* = Analog input filter
- S* = Serial communications configuration
- t* = Serial communications parity

**Note.** For custom settings contact the local distributor.

Continued on page 30.

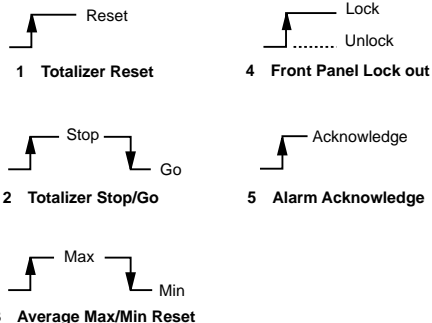

#### Information.

Digital input options 1, 2, 3 and 5 are edge-triggered to enable the front panel keys to change the function when the digital input is operational.

**Fig. 4.8 Digital Function Configuration**



**P 0000** P – Digital Input Function

Display	
0	None
1	Totalizer Reset
2	Totalizer Stop/Go
3	Average, Max/Min Reset
4	Front Panel Lockout
5	Alarm Acknowledge

**r 0000** R – Analog Input Filter

Display	
0	0 seconds
1	1 second
2	2 seconds
5	5 seconds
R	10 seconds
b	20 seconds
ƒ	40 seconds
D.	60 seconds

**5 0000** S – Serial Communication Configuration

Display	Baud Rate, 2/4 Wire
0	Off
1	2400, 2-Wire
2	2400, 4-Wire
3	9600, 2-Wire
4	9600, 4-Wire

**ƒ 0000** T – Serial Communication Parity

Display	
0	None
1	Odd
2	Even

**Note.** Settings for options P, S and T are only available if the appropriate option board is fitted.

**Fig. 4.9 Digital Function and Serial Communications Configuration**



### 4.4 Ranges and Passwords (Level 4)

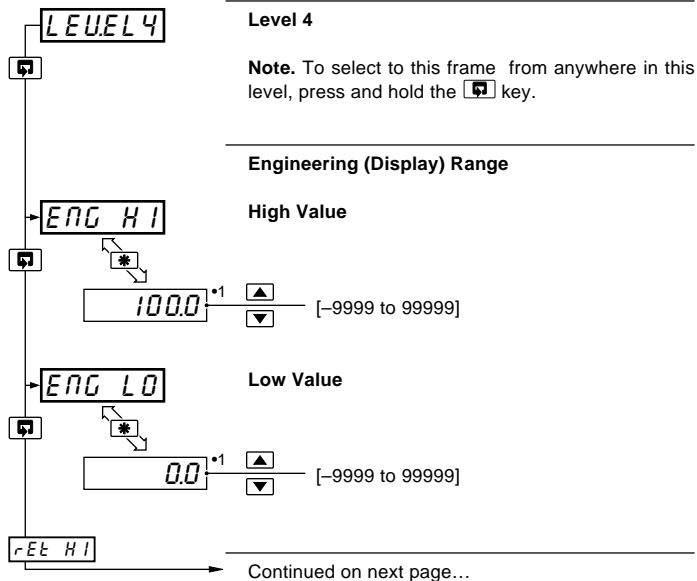

- 1 The engineering range high and low values are automatically set to the maximum allowed value when thermocouple or RTD is selected in the Configuration Level – see Section 4.3.1. This value can be modified if required.



#### ...4.4 Ranges and Passwords (Level 4)

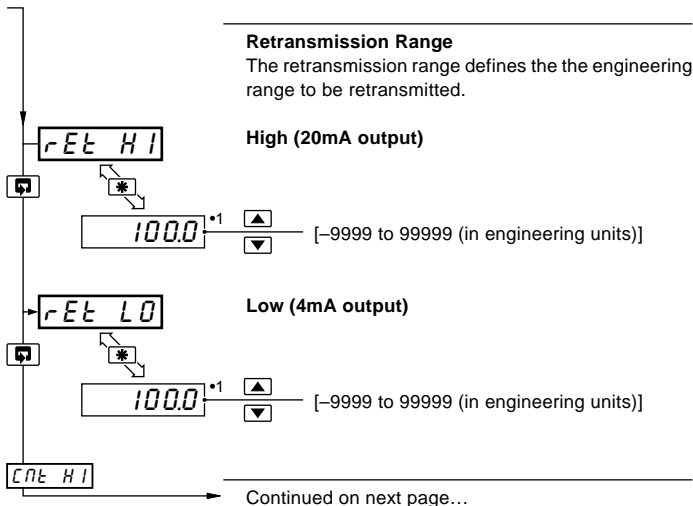

- \*1 The retransmission range high and low values are automatically set to the maximum allowed value when thermocouple or RTD is selected in the configuration level – see Section 4.3.1. This value can be modified if required.



### ...4.4 Ranges and Passwords (Level 4)

 CnE HI* <sup>1</sup>	<b>Totalizer Count High</b> This frame determines the count corresponding to the full-scale input.
 100	<input type="button" value="▲"/> [0.000 and 99.999 pulses/second] <input type="button" value="▼"/>
 cut.off* <sup>1</sup>	<b>Cut-off</b> This frame sets the lowest flow value at which the totalizer is to stop counting.
 1000	<input type="button" value="▲"/> [In engineering units] <input type="button" value="▼"/>
 S-PASS	<b>Setup Password</b> This password enables access to the set-up level (Level 2).
 0	<input type="button" value="▲"/> [0 to 9999] <input type="button" value="▼"/>
 C-PASS	<b>Configuration Password</b> This password enables access to the configuration levels. (Levels 3 and 4).
 0	<input type="button" value="▲"/> [0 to 9999] <input type="button" value="▼"/>
 Addr.* <sup>2</sup>	<b>MODBUS™ Address</b> This frame sets the MODBUS™ address.
 1	<input type="button" value="▲"/> [1 to 99] <input type="button" value="▼"/>

\*1 Displayed only if enabled in the configuration level – see Section 4.3.3.

\*2 Available only if the appropriate option board is fitted.



## 5 INSTALLATION

### EC Directive 89/336/EEC

In order to meet the requirements of the EC Directive 89/336/EEC for EMC regulations, this product must not be used in a non-industrial environment.

#### 5.1 Siting – Figs 5.1 and 5.2

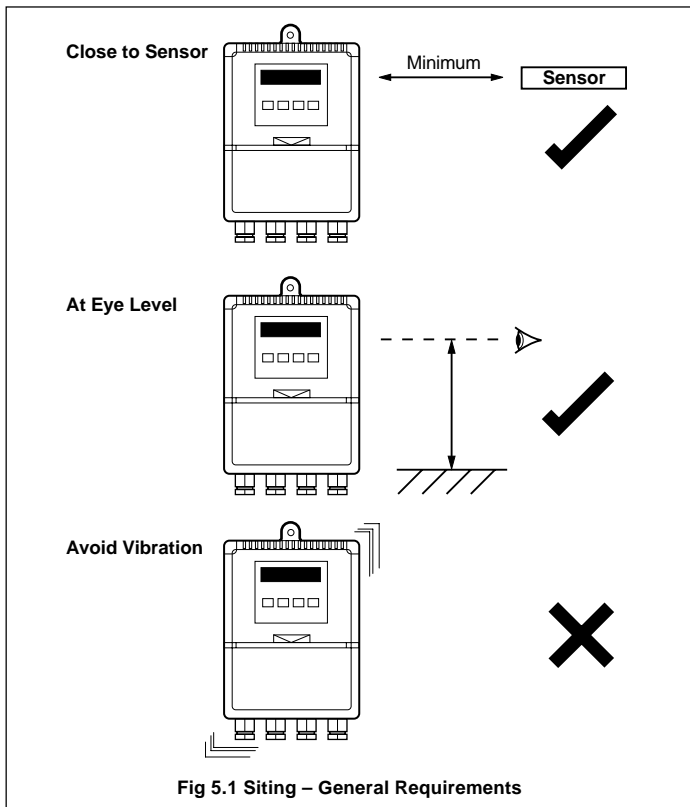



### ...5.1 Siting – Figs 5.1 and 5.2

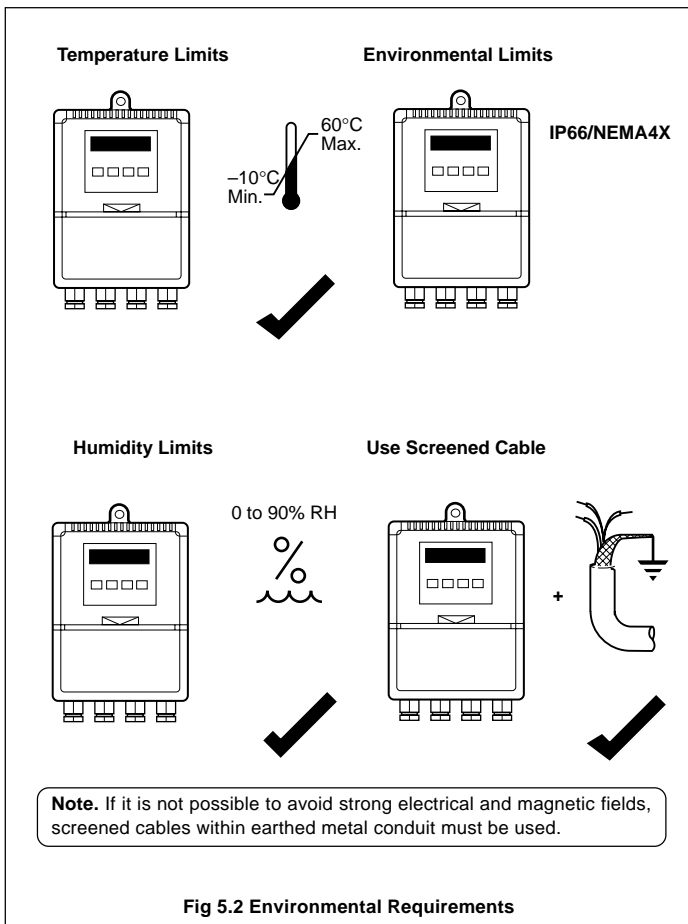



## 5.2 Mounting – Figs. 5.3 and 5.4

The instrument is designed for wall-mounting or pipe-mounting (see Fig. 5.4). The pipe-mounting kit (part no. 4600/0138) is suitable for both vertical and horizontal pipes. Overall dimensions are shown in Fig. 5.3.

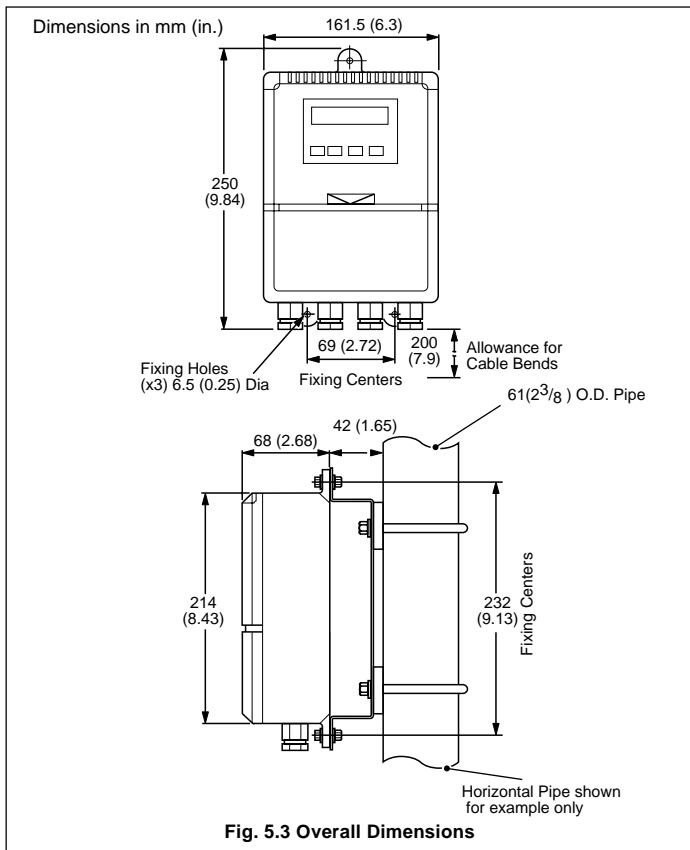



### ...5.2 Mounting – Figs. 5.3 and 5.4

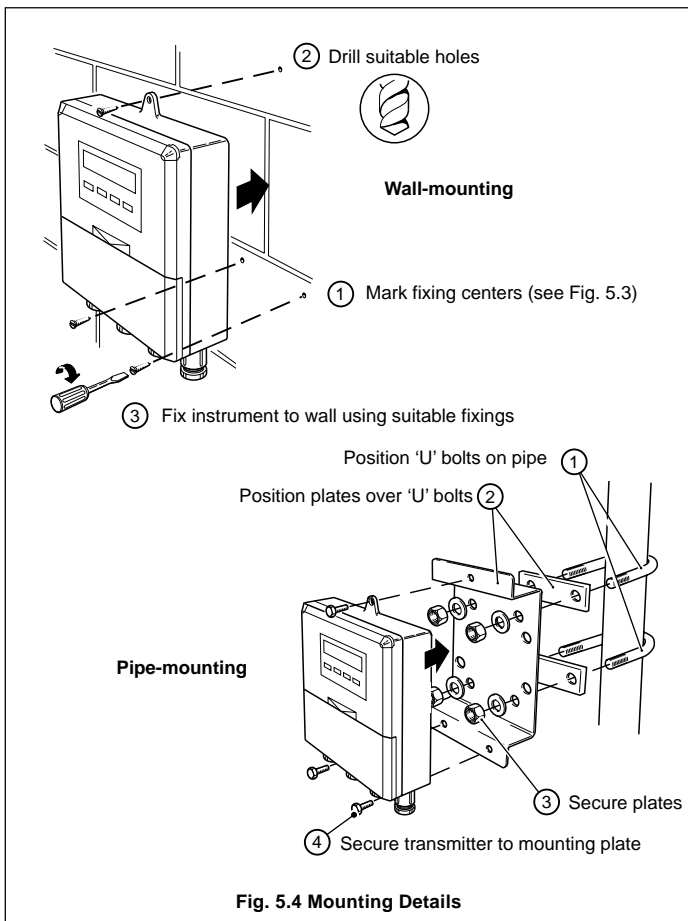



### 5.3 Cable Glands and Conduit Fixings

#### 5.3.1 Cable Glands (IEC – 20mm) – Fig. 5.5

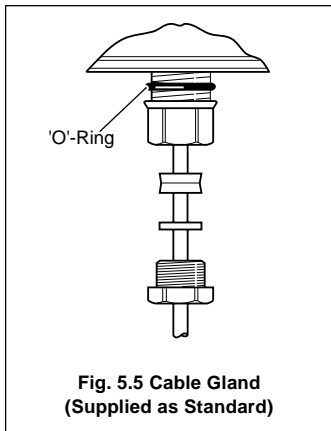

#### 5.3.2 Conduit Adapters (N. American – 0.5 in.) – Fig. 5.6

##### Warning.

- Rigid conduit must NOT be fitted to the Indicator.
- Indicator adapters must incorporate a face seal.
- Torque settings for the hubs and outer nuts on the specified adapters is 20ft.lbs minimum, 25ft.lbs. maximum.

#### ...5.3.2 Conduit Adapters (N. American – 0.5 in.) – Fig. 5.6

##### Information.

- Suitable adapters for indicator (mandatory for FM installations):  
 APPLETON  
 ST-50 PLUS STG-50 or  
 STB-50 PLUS STG-50.  
 Reusable ONLY with  
 replacement ferrule STF-50.  
 O.Z. GEDNEY  
 4Q-50, 4Q50T or 4Q-50TG.

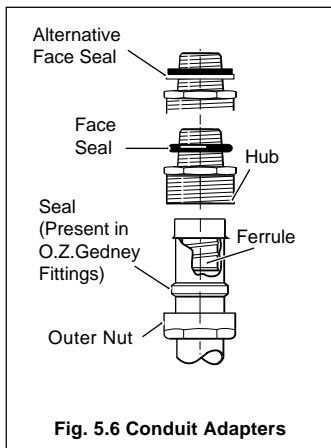



### 5.3.3 Cable Glands (N. American – 0.5 in.) – Fig. 5.7

#### Warning.

- Indicator glands must be fitted with a face seal.
- Torque settings (hubs only) – 20ft. lbs minimum, 25ft. lbs. maximum.
- Outer nuts – hand tight plus a half turn only.

#### Information.

- Suitable Cable Glands: (mandatory for FM installations):  
O.Z. GEDNEY SR-50-375 or SR-504  
APPLETON CG 3150 or CG-3150S (and STG-50 sealing ring).  
THOMAS & BETTS 2521.
- When fitting cable glands to the Indicator, start with an outer gland and also temporarily fit a gland at the opposite end, to aid location of the transmitter gland plate. Fit and tighten glands consecutively from initial gland.

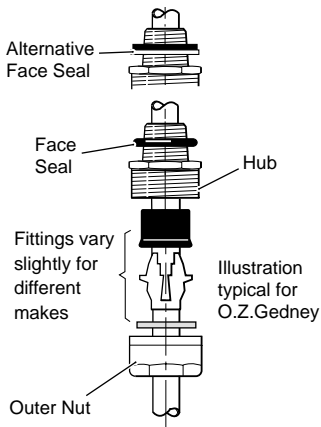

Fig. 5.7 Cable Glands



## 5.4 Electrical Connections – Fig. 5.8

**Warning.** Before making any connections, ensure that the instrument power supply, any powered control circuits and high common mode voltages are switched off.

**Note.** The analog output and the logic output share a common positive and can be used at the same time.

### 5.4.1 Relay Contact Ratings

Relay contacts are rated at:

115/230V a.c. at 5A (non-inductive)

250V d.c. 25W max.

### 5.4.2 Arc Suppression

Arc suppression components are fitted to relays 2 and 3 only. If relay 1 is required to switch inductive loads, the arc suppression components supplied must be fitted.

### 5.4.3 Logic Output

18V d.c. at 20mA

Min. load 900 $\Omega$

Isolation 500V from input (not isolated from retransmission output)

### 5.4.4 Retransmission Analog Output

Max. load 15V (750 $\Omega$  at 20mA)

Isolation 500V from input (not isolated from logic output)

**Note.** Problems may be encountered if the retransmission analog output is connected to devices with a very fast sampling rate. A 100 $\mu$ F 63V electrolytic capacitor can be fitted across terminals 8 (+ve) and 20 (-ve).

### 5.4.5 Digital Input

Type: Volt-free

Minimum pulse: 250 ms



## ...5 INSTALLATION

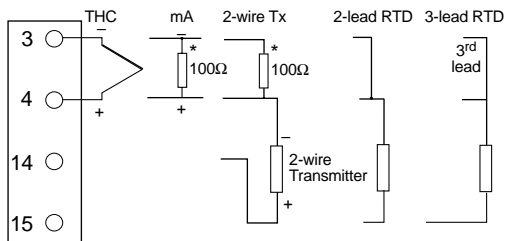
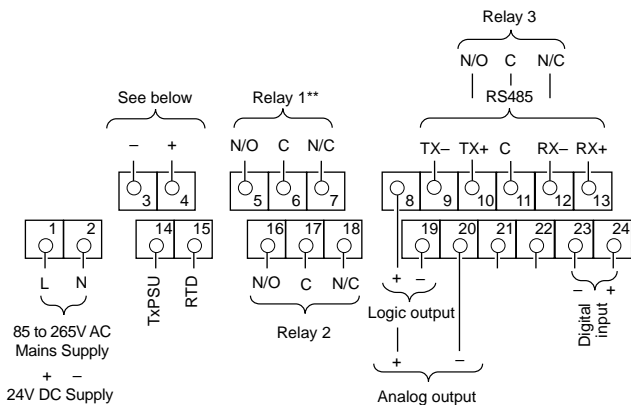

\* Fit 100Ω resistor supplied

\*\* Fit arc suppression components

**Fig. 5.8 Electrical Connections**

# 6 SPECIFICATION

## Summary

Fully user-configurable universal indicator  
IP66/NEMA4X all-round protection  
Large 5-digit display  
Totalizer/math functions as standard

## Operation

### Display

High-intensity 7-segment, 1 x 6-digit LED display  
Three alarm LED indicators

Display range	process value	-9999 to +99999
	totalization	0 to 999999
Display resolution		±1 digit
Display height		14mm (0.56 in.)

### Configuration

User-defined via front panel or PC configurator

## Standard Functions

### Totalizer

Six-digit, batch and secure totals

### Alarms

Number	Three user-defined
Types	High/Low process High/Low latch Fast/Slow rate

### Maths function

Maximum and minimum value detection  
Average value calculation

## Analog Input

### Input sampling rate

250ms

### Type

Universally configurable to provide:  
Thermocouple (THC)  
Resistance Thermometer (RTD)  
Millivolt  
Current  
DC Voltage

### Input impedance

mA	100K
mV, V	>10MK

### Linearizer functions

Programmable for:  
Square root, THC types B, E, J, K, N, R, S, T or Pt100  
Custom 20-breakpoint linearizer, set up by PC configurator

### Broken sensor protection

Upscale drive on thermocouple and RTD  
Downscale drive on milliamps and voltage

### Cold junction compensation

Automatic CJC incorporated as standard  
Stability <0.05°C/°C change in ambient temperature

### Input protection

Common mode isolation	>120dB at 50/60Hz with 300K imbalance resistance
Series mode rejection	>60dB at 50/60Hz

### Transmitter power supply

24V, 30mA max. to power one 2-wire transmitter

## Inputs/Outputs

### Retransmission

Analog, configurable in the range of 4 to 20mA  
Max. load 15V (750K at 20mA)  
Accuracy A 0.25% of span  
Isolation 500V DC from input (not isolated from logic output)  
Assignable to Process Variable or Average PV

### Logic output

Rating	18V DC at 20mA
Min. load	400K
Isolation	500V from input (not isolated from retransmission output)

### Relay output

Number	2 standard (+ 1 optional)
Rating	(SPDT) 5A at 115/230V AC
Function wrap	Alarms, totalizer count pulse, totalizer pulse or end of batch alarm.

### Digital input

Type	Volt-free
Minimum pulse	250ms

## Options

### Modbus serial communications

Connections	RS422/RS485, 2 or 4-wire
Speed	2.4k or 9.6k baud rate
Protocol	Modbus RTU slave

## ...6 SPECIFICATION

### Physical

#### Size

160mm (6.3 in.) wide x 250mm (9.84 in.) high x  
68mm (2.68 in.) deep

#### Weight

2kg (4.5 lb) approx.

#### Mounting Option

Wall-mounted  
Pipe-mounted with optional kit Pt. No. 4600/0138

### Electrical

#### Voltage

85 to 265V AC 50/60Hz  
24V DC (option)

#### Power consumption

<6VA AC  
<5W DC

#### Power interruption protection

<60ms/< 3 cycles, no effect  
>60ms/>3 cycles, instrument returns to operation after a  
controlled reset

### Environmental

#### Operating limits

-10 to 55°C (32 to 131°F)  
5 to 95% RH non-condensing

#### Temperature stability

<0.02% of reading or 2µV/°C (1µV/°F)

#### Enclosure

IP66/NEMA4X

### EMC

#### Emissions

Meets requirements of EN50081-2

#### Immunity

Meets requirements of EN50082-2

#### Design and manufacturing standards

CE mark

#### Electrical safety

EN61010 - 1

### Standard Analog Input Ranges

Thermocouple	Maximum Range °C	Maximum Range °F	Accuracy (% of reading)
B	-18 to 1800	0 to 3270	0.1% or ±2°C (3.6°F) [above 200°C (392°F)] *
E	-100 to 900	-140 to 1650	0.1% or ±0.5°C (0.9°F)
J	-100 to 900	-140 to 1650	0.1% or ±0.5°C (0.9°F)
K	-100 to 1300	-140 to 2350	0.1% or ±0.5°C (0.9°F)
G	-200 to 1300	-325 to 2350	0.1% or ±0.5°C (0.9°F)
R	-18 to 1700	0 to 3000	0.1% or ±1.0°C (1.8°F) [above 300°C (572°F)] *
S	-18 to 1700	0 to 3000	0.1% or ±0.5°C (0.9°F) [above 200°C (392°F)] *
T	-250 to 300	-400 to 550	0.1% or ±0.5°C (0.9°F)

\* For B, R and S thermocouples, performance accuracy is not guaranteed below value stated

Min. span below zero Type T 70°C (128°F)  
Type N 109°C (189°F)

THC standards: DIN 43710  
IEC 584

RTD	Maximum Range °C	Maximum Range °F	Accuracy (% of reading)**
Pt100	-200 to 600	-325 to 1100	0.1% or ±0.5°C (0.9°F)

\*\* RTD, 3-wire platinum, 100K per DIN 43760 standard (IEC 751), with range of 0 to 400K

Linear Inputs	Range	Accuracy (% of reading)
Milliamps	0 to 20mA	0.2% or ±2µA
Milliamps	4 to 20mA	0.2% or ±2µA
Volts	0 to 5V	0.2% or ±200µV
Volts	1 to 5V	0.2% or ±200µV
Millivolts	0 to 50mV	0.1% or ±20µV

Square Root Input	Range	Accuracy (% of reading)***
Milliamps	4 to 20mA	0.2% or ±2µA

\*\*\* Below input of 4.84mA (20% flow) the input is linear

---

## NOTES

---





# CUSTOMER CONFIGURATION LOG



LEVEL 3

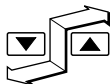

LEVEL 4

ENG HI

R 1XCO

ENG LO

A \_ B \_ C \_ D \_

rEt HI

E 0000

rEt LO

E \_ F \_ G \_ H \_

CnE HI

J 0000

CUTOFF

J \_ K \_ L \_ N \_

S-PASS

P 0000

C-PASS

P \_ R \_ S \_ T \_

Addr.

# CUSTOMER SETUP LOG



LEVEL 1

Code

LEVEL 2

R 1xx

R 2xx

R 3xx

xxxxxx

t-GO

SEctot

PrESEt

PrEdEt

R xxxx

H xxxx

L xxxx

ORdJ

Instrument Serial Number: \_\_\_\_\_

Product Code: C 1 6 0 / \_ \_ \_ \_ / \_ \_ \_ \_

## Customer Support

We provide a comprehensive after sales service via a Worldwide Service Organization. Contact one of the following offices for details on your nearest Service and Repair Centre.

### United Kingdom

ABB Limited

Tel: +44 (0)1480 475 321

Fax: +44 (0)1480 217 948

### United States of America

ABB Inc.

Tel: +1 215 674 6000

Fax: +1 215 674 7183

#### Client Warranty

Prior to installation, the equipment referred to in this manual must be stored in a clean, dry environment, in accordance with the Company's published specification. Periodic checks must be made on the equipment's condition.

In the event of a failure under warranty, the following documentation must be provided as substantiation:

1. A listing evidencing process operation and alarm logs at time of failure.
2. Copies of all storage, installation, operating and maintenance records relating to the alleged faulty unit.

---

**ABB** has Sales & Customer Support expertise  
in over 100 countries worldwide

[www.abb.com](http://www.abb.com)

The Company's policy is one of continuous product  
improvement and the right is reserved to modify the  
information contained herein without notice.

Printed in UK (07.05)

© ABB 2005



**ABB Limited**

Howard Road, St. Neots  
Cambridgeshire  
PE19 8EU  
UK

Tel: +44 (0)1480 475 321

Fax: +44 (0)1480 217 948

**ABB Inc.**

125 E. County Line Road  
Warminster  
PA 18974  
USA

Tel: +1 215 674 6000

Fax: +1 215-674 7183