

AV410, AV411, AV412, AV420 and AV422

Single and dual input dissolved organics monitor



The Company

We are an established world force in the design and manufacture of measurement products for industrial process control, flow measurement, gas and liquid analysis and environmental applications.

As a part of ABB, a world leader in process automation technology, we offer customers application expertise, service and support worldwide.

We are committed to teamwork, high quality manufacturing, advanced technology and unrivalled service and support.

The quality, accuracy and performance of the Company's products result from over 100 years experience, combined with a continuous program of innovative design and development to incorporate the latest technology.

EN ISO 9001:2000



Cert. No. Q 05907

EN 29001 (ISO 9001)



Lenno, Italy – Cert. No. 9/90A

Stonehouse, U.K.



Electrical Safety

This equipment complies with the requirements of CEI/IEC 61010-1:2001-2 'Safety Requirements for Electrical Equipment for Measurement, Control and Laboratory Use'. If the equipment is used in a manner NOT specified by the Company, the protection provided by the equipment may be impaired.

Symbols

One or more of the following symbols may appear on the equipment labelling:

	Warning – Refer to the manual for instructions
	Caution – Risk of electric shock
	Protective earth (ground) terminal
	Earth (ground) terminal

	Direct current supply only
	Alternating current supply only
	Both direct and alternating current supply
	The equipment is protected through double insulation

Information in this manual is intended only to assist our customers in the efficient operation of our equipment. Use of this manual for any other purpose is specifically prohibited and its contents are not to be reproduced in full or part without prior approval of the Technical Publications Department.

Health and Safety

To ensure that our products are safe and without risk to health, the following points must be noted:

1. The relevant sections of these instructions must be read carefully before proceeding.
2. Warning labels on containers and packages must be observed.
3. Installation, operation, maintenance and servicing must only be carried out by suitably trained personnel and in accordance with the information given.
4. Normal safety precautions must be taken to avoid the possibility of an accident occurring when operating in conditions of high pressure and/or temperature.
5. Chemicals must be stored away from heat, protected from temperature extremes and powders kept dry. Normal safe handling procedures must be used.
6. When disposing of chemicals ensure that no two chemicals are mixed.

Safety advice concerning the use of the equipment described in this manual or any relevant hazard data sheets (where applicable) may be obtained from the Company address on the back cover, together with servicing and spares information.

CONTENTS

1 INTRODUCTION	2	6 INSTALLATION	32
1.1 Introduction	2	6.1 Siting Requirements	32
1.2 Principle of Operation	2	6.1.1 Transmitter	32
1.3 AV400 Series Systems	2	6.1.2 Sensor	32
2 OPERATION	3	6.2 Mounting the Transmitter	33
2.1 Powering Up the Monitor	3	6.3 Installing the Sensor	34
2.2 Displays and Controls	3	6.4 Installing the Optional De-bubbler	36
2.2.1 Membrane Key Functions	3	6.5 Electrical Connections	38
2.3 Operating Page	6	6.5.1 Relay Contact Protection and Interference Suppression	39
2.3.1 Single Input Dissolved Organics	6	6.5.2 Cable Entry Knockouts	40
2.3.2 Dual Input Dissolved Organics	7	6.5.3 Access to Terminals	41
2.3.3 Wash Function	8	6.5.4 Connections	42
3 OPERATOR VIEWS	9	7 CALIBRATION	43
3.1 View Set Points	9	7.1 Factory Settings	43
3.2 View Outputs	10	8 SENSOR MAINTENANCE	50
3.3 View Hardware	10	8.1 Scheduled Maintenance	50
3.4 View Software	11	8.2 Cleaning the Sensor	50
3.5 View Clock	11	8.2.1 Dismantling and Cleaning	50
3.6 View Logbook	12	8.3 Replacing the Emitter and Receiver Modules	55
4 SETUP	14	8.4 Adjusting the Emitter Brightness	55
4.1 Sensor Calibration Standard Solutions	14	9 DIAGNOSTICS	56
4.1.1 Zero Standard Solution	14	9.1 Status Messages	56
4.1.2 Span Standard Solution	14	9.2 Unstable or Erratic Readings	56
4.1.3 Calibration Checks	14	10 SPARES	57
4.2 Sensor Calibration	15	SPECIFICATION	58
5 PROGRAMMING	17	APPENDIX A REPLACING A 7320 TRANSMITTER WITH AN AV400	60
5.1 Security Code	17		
5.2 Configure Display	18		
5.3 Configure Sensors	19		
5.4 Configure Alarms	21		
5.5.1 Wash Cycle Configuration (applicable only to Alarm 3)	23		
5.5 Configure Outputs	25		
5.6 Configure Clock	26		
5.7 Configure Logbook	27		
5.8 Configure Security	27		
5.9 Test Outputs and Maintenance	28		

Analyzer Model Number	Description of Analyzer	Sensor A	Sensor B
AV410	Single Input Low Range	7320 100	–
AV411	Dual Input Low Range	7320 100	7320 100
AV412	Dual Input Low and High Range	7320 100	7320 200
AV420	Single Input High Range	7320 200	–
AV422	Dual Input High Range	7320 200	7320 200

Table 1.1 AV400 Series Dissolved Organics Monitor Options

1 INTRODUCTION

1.1 Introduction



Warning. The sensor emitter module contains a high intensity xenon strobe lamp that emits ultraviolet (UV) radiation. ***This must NOT be viewed with the naked eye and must NEVER be operated while outside the sensor.*** Under normal operating conditions, it is not possible to see the light source but, if the sensor is dismantled with electrical power applied, it may be possible to expose the eyes to the strobe flash.

Many dissolved organic compounds (DOC) found commonly in potable water absorb ultraviolet radiation. These include Humic Acids, that gives water a characteristic yellow color, and dissolved organics, that result in the formation of Trihalomethanes (THMs).

The monitor is designed for use as a surrogate color monitor, coagulation monitor/controller and to monitor for THM precursors in potable water treatment plants.

1.2 Principle of Operation

The broad-spectrum, high intensity xenon strobe lamp, housed in the emitter module, generates pulses of light that pass through the sample water in the flowcell to a filtering and detection system, contained in the receiver module. The received light pulses are analyzed at two wavelengths; the measurement wavelength of 254 nm and the reference wavelength of 405 nm (at which the sample constituents of interest do not absorb). This dual light path system provides information that enables the measured value to be corrected for any turbidity due to suspended matter in the sample. The monitor is calibrated with a pure solution of a suitable organic compound of known carbon content.

An automatic, microprocessor-controlled, dual-wiper system, housed in the cleaner module, cleans the flowcell optical windows periodically to ensure that the sensor remains functional. Samples containing large solids and/or very high concentrations of solids must be pre-filtered.

1.3 AV400 Series Systems – Fig. 1.1

Note. An AV400 System is supplied factory-configured as a matched system with each component bearing the same serial number. If any part of a system is replaced (transmitter or sensor[s]), ***a complete factory re-calibration must be carried out*** – see Section 7.

- The **AV410** and **AV411** low range monitors are primarily for use in potable water applications, such as monitoring the effectiveness of the coagulation control, THM precursor detection and final treated water quality.

Range: **0 to 20mg^l-1 C** maximum.

- The **AV420** and **AV422** high range coagulation monitors are designed for use in potable water treatment plants to predict the coagulant dose to be applied to the raw water and to detect the rise in DOC from algal bloom toxins.

Range: **0 to 100mg^l-1 C** maximum.

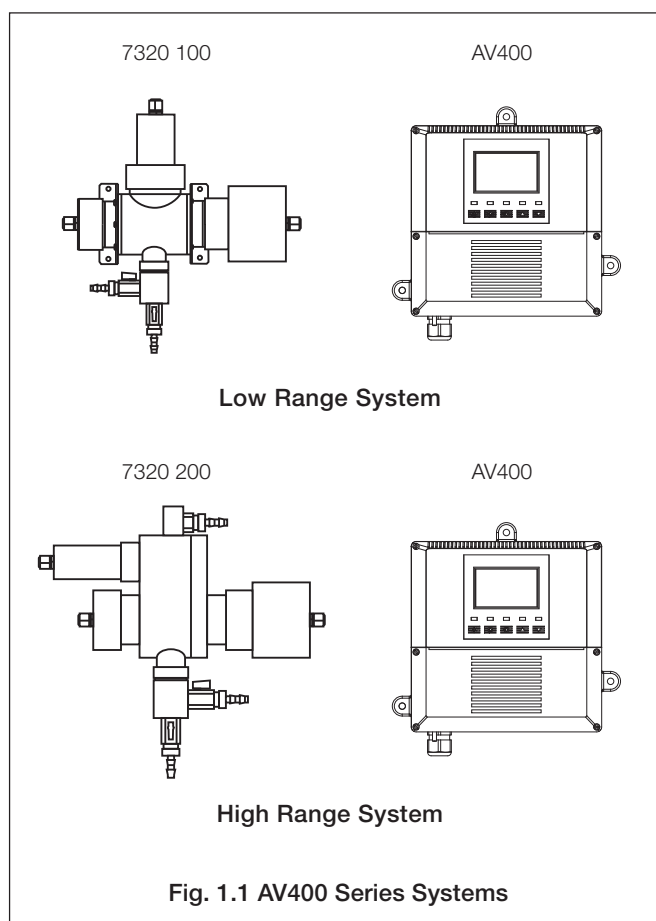

2 OPERATION

2.1 Powering Up the Monitor



Warning. Ensure all connections are made correctly, especially to the earth studs – see Section 6.5.

- 1) Ensure the input sensor(s) is (are) connected correctly.
- 2) Switch on the power supply to the transmitter. A start-up screen is displayed while internal checks are performed; then the *Operating Page* (Section 2.3) is displayed as the dissolved organics measuring operation starts.

2.2 Displays and Controls – Fig. 2.1

The upper and center display lines each comprise a 4½ digit, 7-segment digital display that shows the actual value of the measured parameter and alarm set points, followed by a 6-character dot matrix display showing the associated units. The lower line is a 16-character dot matrix display showing operating and programming information.

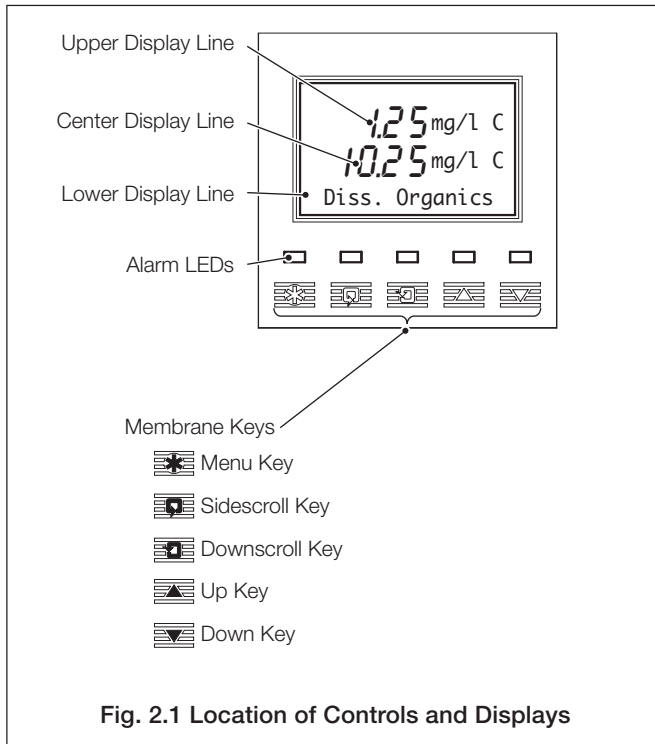

2.2.1 Membrane Key Functions – Fig. 2.2

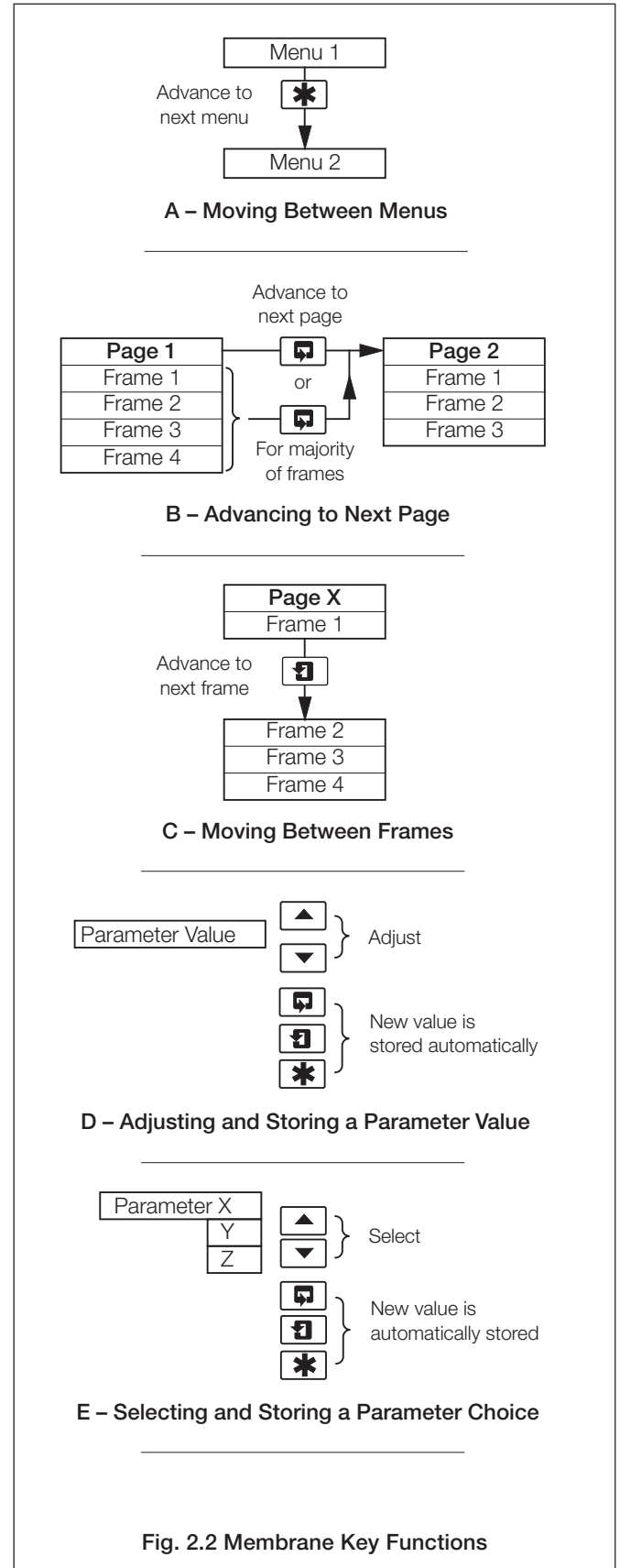

Fig. 2.2 Membrane Key Functions

...2 OPERATION

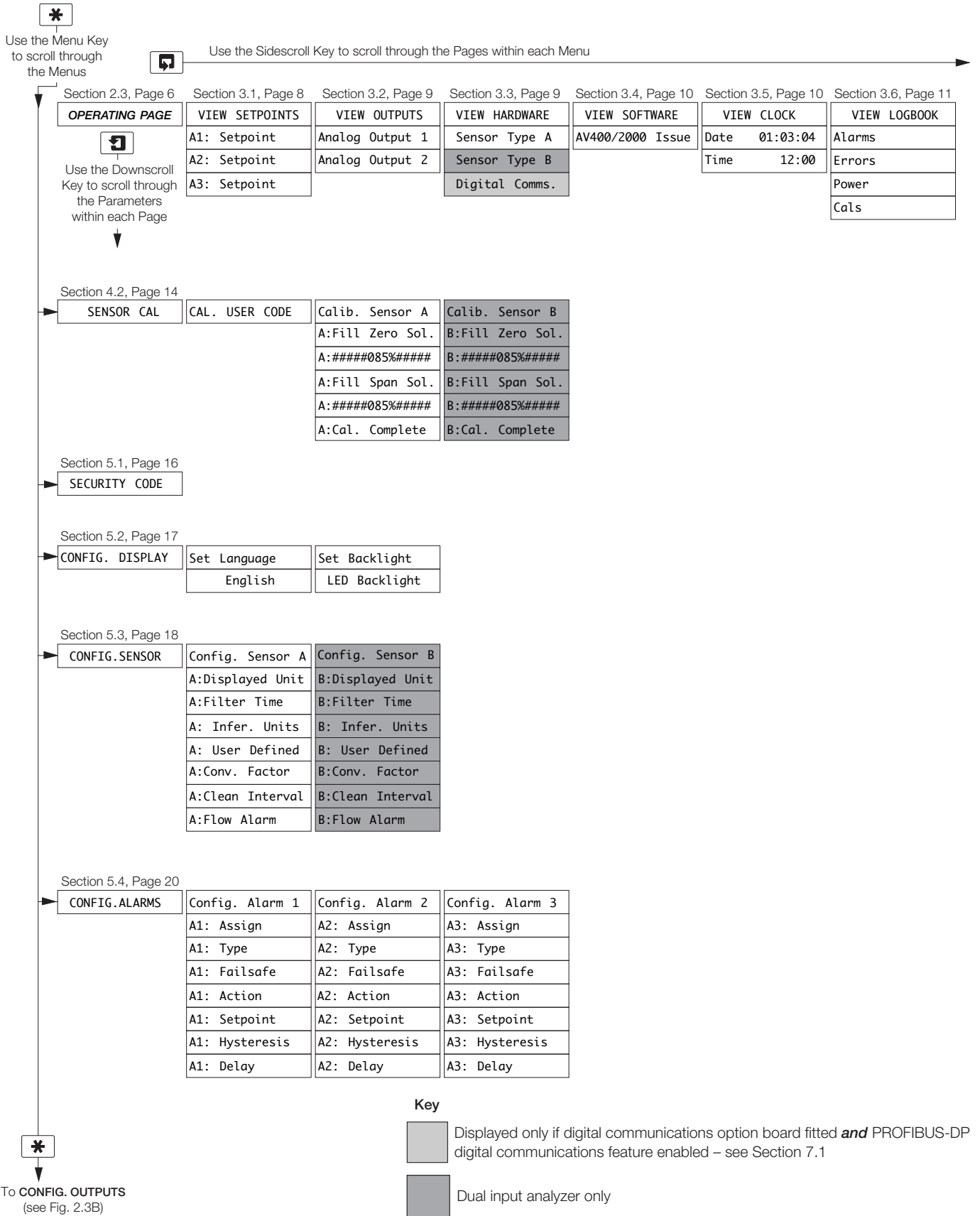

Fig. 2.3A Overall Programming Chart

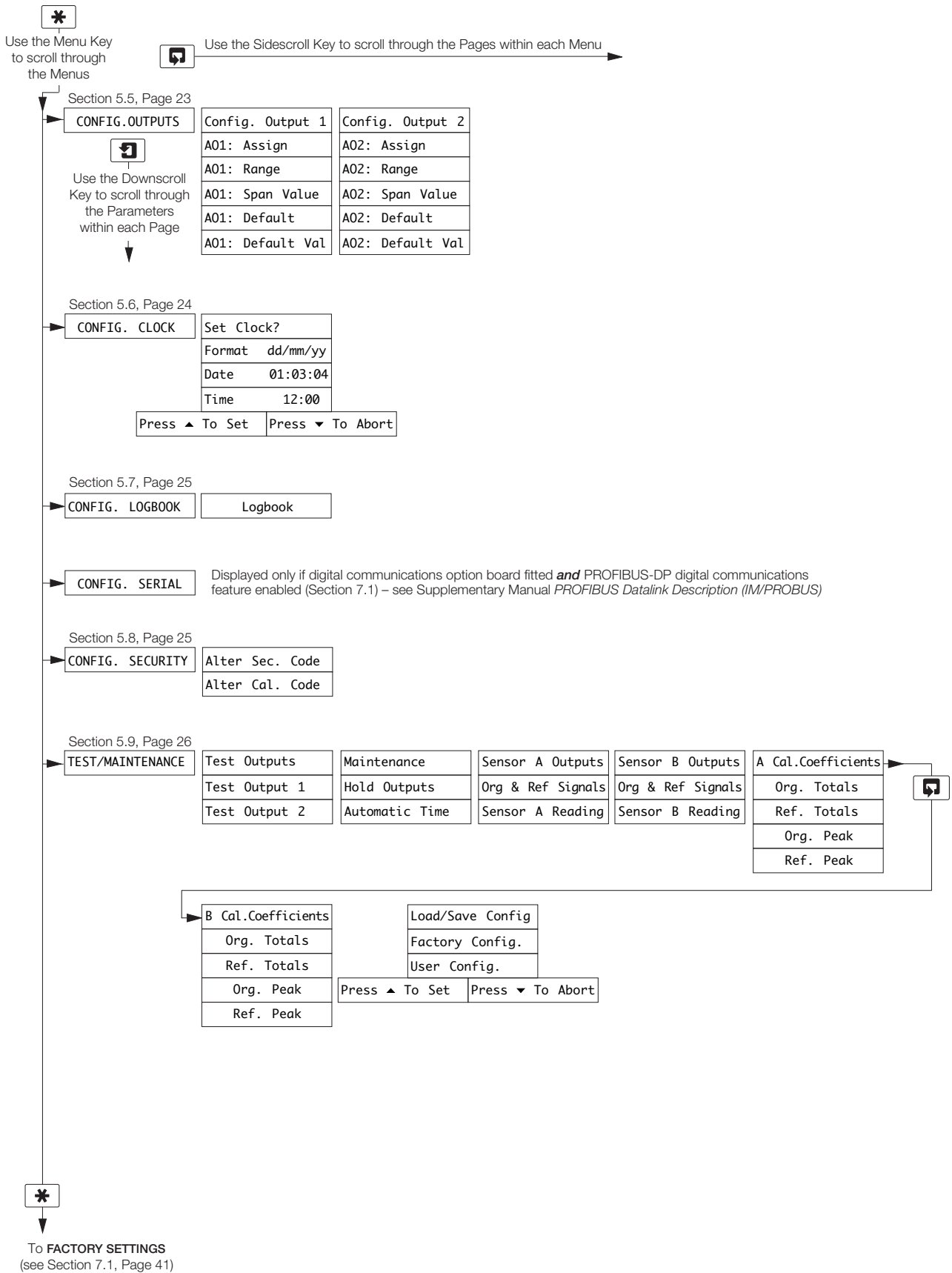
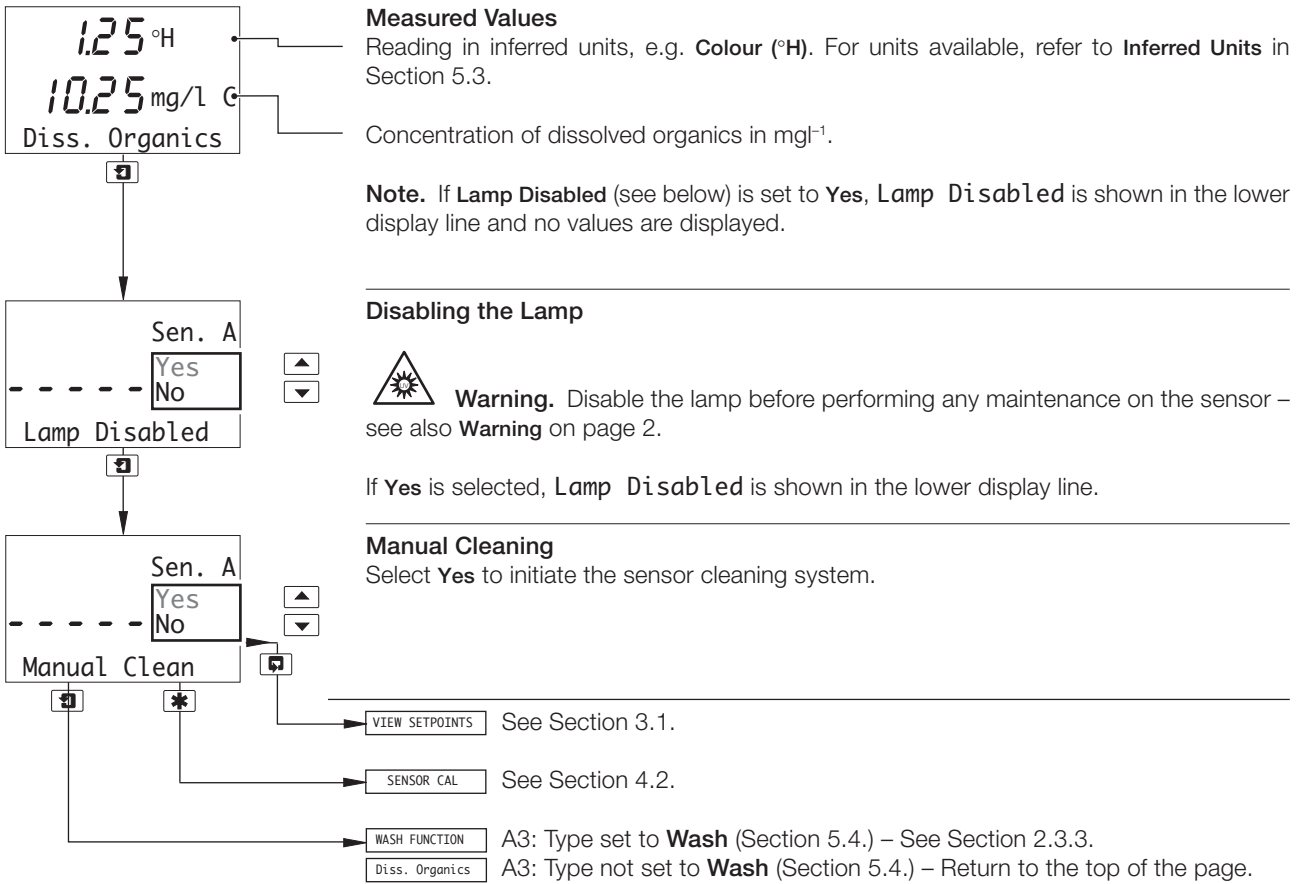

Fig. 2.3B Overall Programming Chart

2.3 Operating Page

2.3.1 Single Input Dissolved Organics



...2.3 Operating Page

2.3.2 Dual Input Dissolved Organics

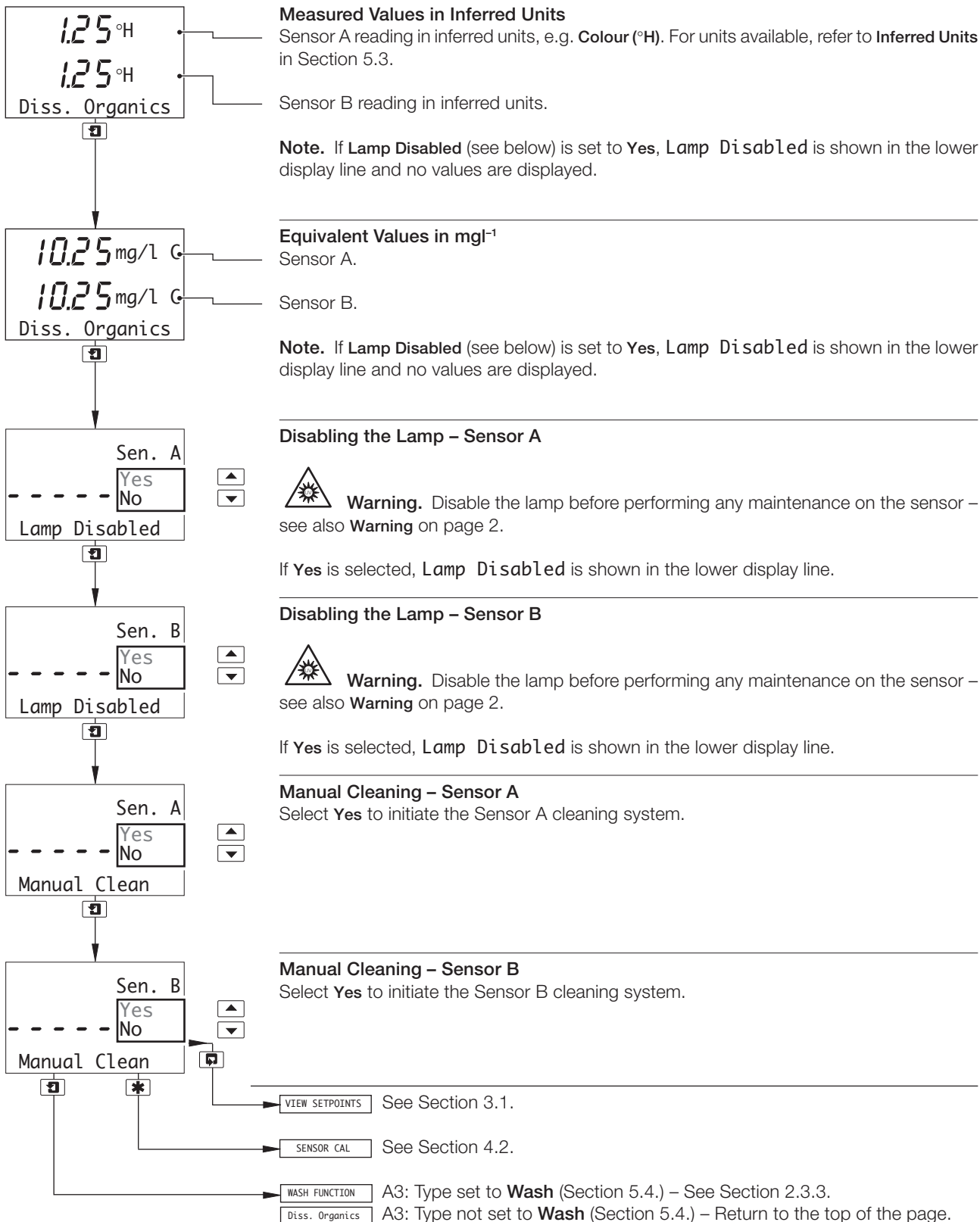

...2 OPERATION

...2.3 Operating Page

2.3.3 Wash Function

Note. The Wash function is available only if **A3: Type** is set to **Wash** – see Section 5.5.

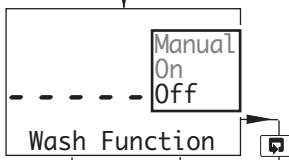

Wash Function

- Off** – Wash function off. Lower display line of *Operating Page* shows **WASH INHIBITED**.
- On** – Wash function controlled automatically. Lower display line of *Operating Page* shows **WASH IN PROGRESS**.
- Manual** – Enables wash function to be initiated manually – see below.

Note. Set **Wash Function** to **Off** before removing the sensor from the process.

VIEW SETPOINTS See Section 3.1.

SENSOR CAL. See Section 4.1.

Press To Wash **Wash Function** set to **Manual** – see below.

Diss. Organics **Wash Function** not set to **Manual**. The display returns to the top of the *Operating Page*.

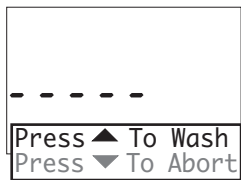

Press to Wash (Manual Wash only)

Press ▲ to Wash and **Press ▼ to Abort** are shown alternately on the lower display line.

WASH IN PROGRESS Press the **▲** key to initiate the wash cycle. The display returns to the top of the *Operating Page* and the lower display line shows **WASH IN PROGRESS** until the wash cycle is completed. The **Wash Function** selection reverts to the one that was set before **Manual** was selected.

Diss. Organics Press the **▼** key to abort the wash cycle. The display returns to the top of the *Operating Page*.

3 OPERATOR VIEWS

3.1 View Set Points

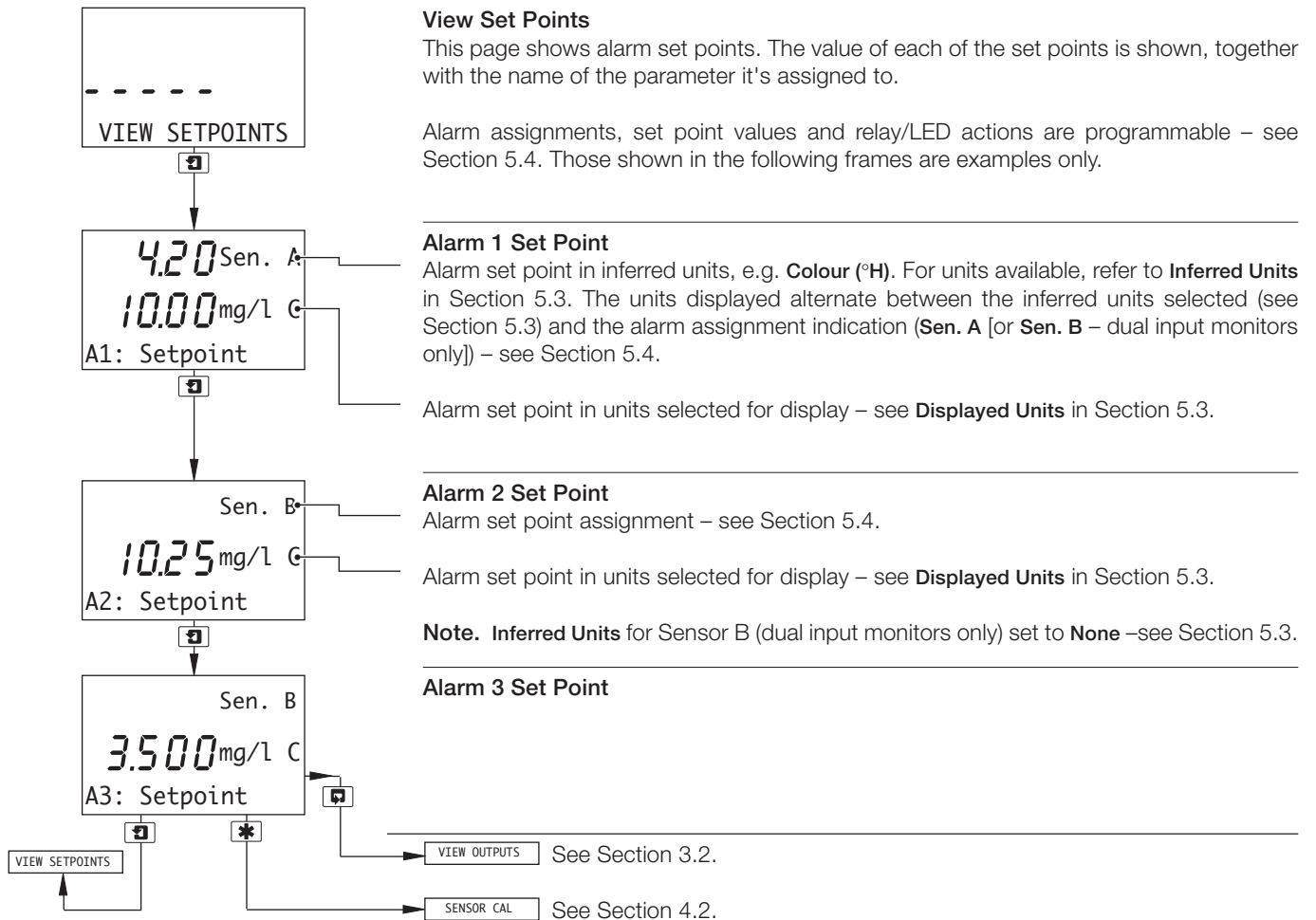

3.2 View Outputs

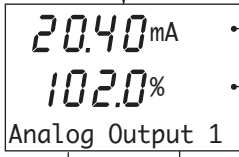
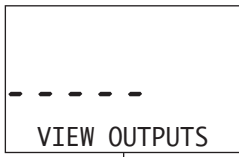

Theoretical Analog Output

There are two analog outputs that are assigned automatically depending on monitor configuration. On a single input monitor, both are assigned to Sensor A. On a dual input monitor, Output 1 is assigned to Sensor A and Output 2 is assigned to Sensor B.

Live current output value being retransmitted.

Current output shown as a percentage of full scale for the output range set in **CONFIG. OUTPUTS** – see Section 5.5.

VIEW HARDWARE See Section 3.3.

SENSOR CAL See Section 4.2.

Analog Output 2 Advance to analog output 2.

3.3 View Hardware

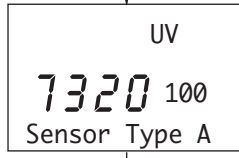
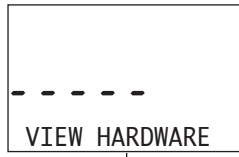

Sensor Type A

Displays the sensor type selected for the Sensor A input in the **Factory Settings** page – see Section 7.1.

7320 100 – Low Range (0 to 20mg^l-1 C)

7320 200 – High Range (0 to 100mg^l-1 C)

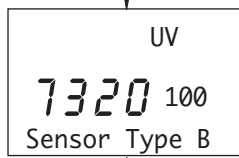

Sensor Type B – Dual input monitors only

Displays the sensor type selected for the Sensor B input in the **Factory Settings** page – see Section 7.1.

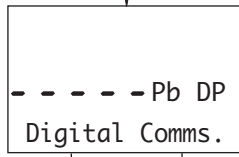

Digital Communications Option Board

Note. Displayed only if the digital communications option board is fitted.

Displays the communications type enabled in the **Factory Settings** page – see Section 7.1.

VIEW HARDWARE

VIEW SOFTWARE See Section 3.4.

SENSOR CAL See Section 4.2.

3.4 View Software

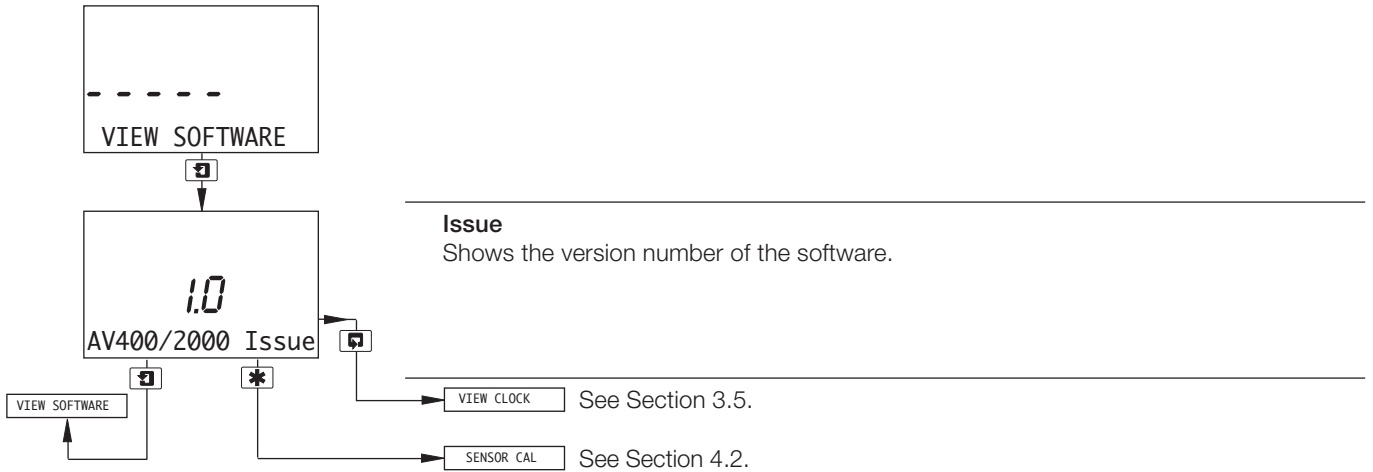

3.5 View Clock

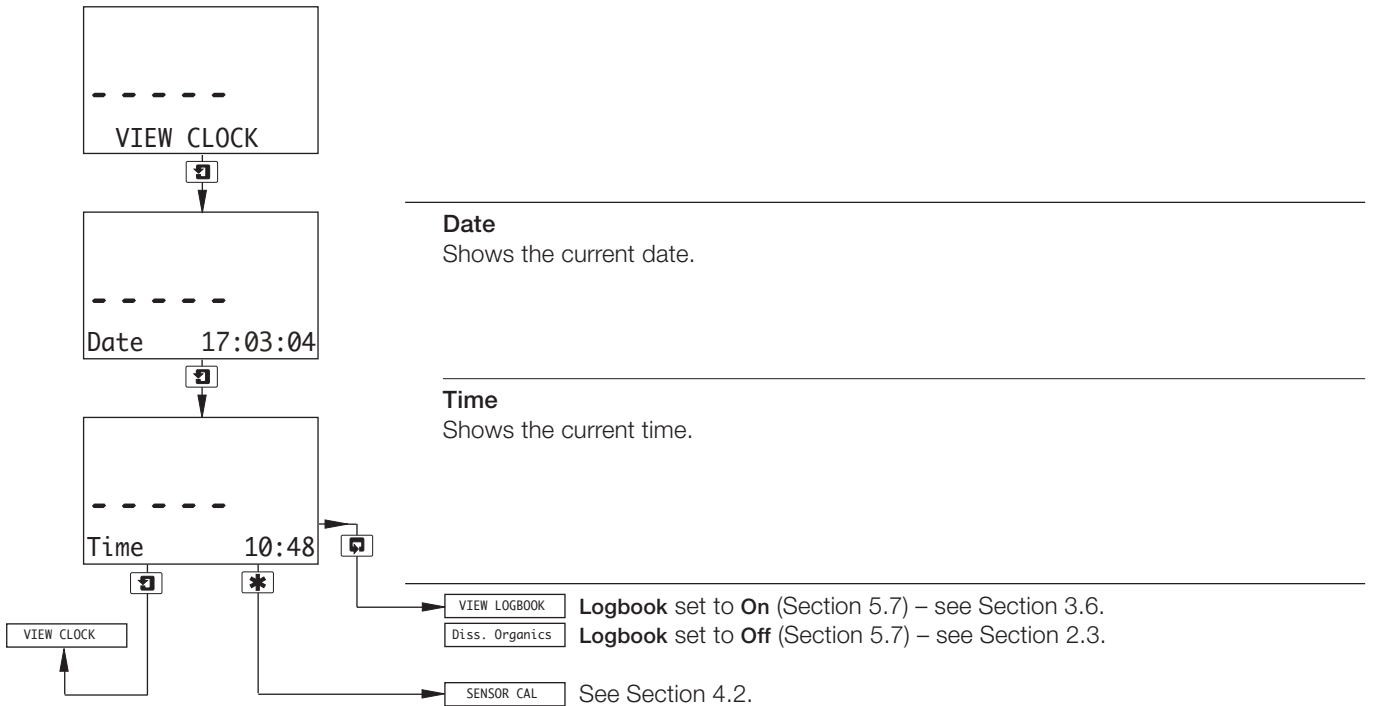

3.6 View Logbook

Note. The View Logbook function is available only if **Logbook** is set to **On** – see Section 5.7.

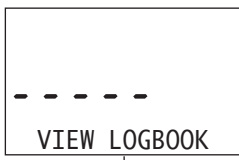

The logbook stores data entries for alarm events, sensor errors, power failures and sensor calibrations.

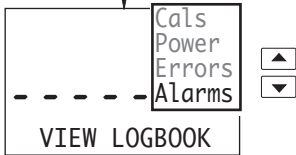

View Logbook

Use the ▲ and ▼ keys to access the **Alarms** logbook.

Note. If no entries are stored in the **Alarms** logbook, the display shows **No More Entries**.

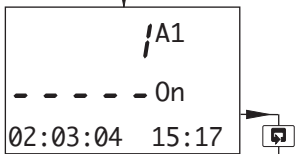

Alarms

The **Alarms** logbook contains up to 10 entries (entry 1 is the most recent), each comprising an alarm number, alarm state (On or Off), and the date/time of the occurrence.



Note. If no more entries are stored, the display shows **No More Entries**.

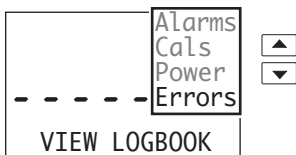

View Logbook

Use the ▲ and ▼ keys to access the **Errors** logbook.

Note. If no entries are stored in the **Errors** logbook, the display shows **No More Entries**.

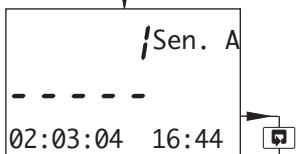

Errors

The **Errors** logbook contains up to 5 entries (entry 1 is the most recent), each comprising the sensor letter, error number, and the date/time of the occurrence.

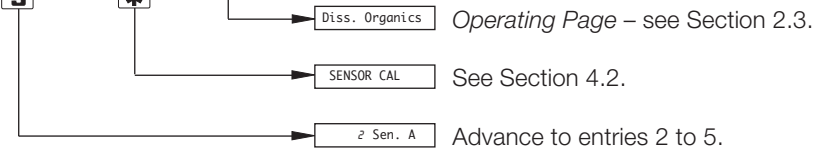

Note. If no more entries are stored, the display shows **No More Entries**.

...3.6 View Logbook

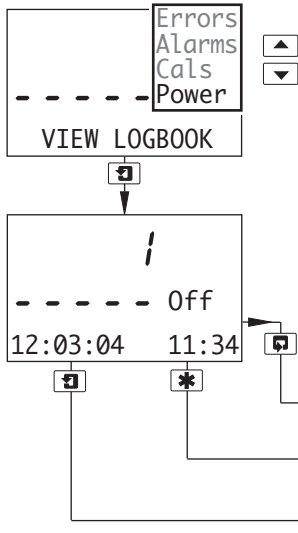

View Logbook

Use the ▲ and ▼ keys to access the **Power** logbook.

Note. If no entries are stored in the **Power** logbook, the display shows **No More Entries**.

Power

The **Power** logbook contains up to 2 entries (entry 1 is the most recent), each comprising the power state (On or Off), and the date/time of the occurrence.

Diss. Organics *Operating Page* – see Section 2.3.

SENSOR CAL See Section 4.2.

2 Advance to entry 2.

Note. If no more entries are stored, the display shows **No More Entries**.

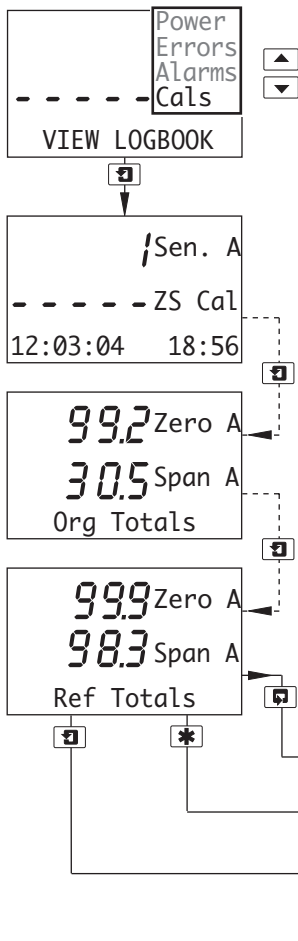

View Logbook

Use the ▲ and ▼ keys to access the **Cals** logbook.

Note. If no entries are stored in the **Cals** logbook, the display shows **No More Entries**.

Calibration

The **Cals** logbook contains up to 5 entries (entry 1 is the most recent), each comprising 3 frames. Frame 1 contains the entry number, sensor letter, calibration type (Z = Zero, S = Span, ZS = Zero and Span) and the date/time of the occurrence.

Frames 2 and 3 contain the raw outputs from the sensor for both the Zero and Span solutions. These values equate to the percentage light transmission through the standard solutions.

Diss. Organics *Operating Page* – see Section 2.3.

SENSOR CAL See Section 4.2.

2 Sen.A Advance to entries 2 to 6 for single input monitors.

2 Sen.A Advance to entries 2 to 3 for sensor A on dual input monitors.

4 Sen.B Advance to entries 4 to 6 for sensor B on dual input monitors.

Note. If no more entries are stored, the display shows **No More Entries**.

4 SETUP

4.1 Sensor Calibration Standard Solutions

UV absorption is a non-specific, aggregate measurement of organic carbon concentration therefore true standards are not available. A standard solution, made from potassium hydrogen phthalate, is used for calibration purposes and the monitor produces readings in units of mg l^{-1} of carbon defined against this calibration standard.

Note. Clean the flowcell internally (see Section 8) before calibration to ensure that the standard solutions, particularly the zero standard, are not contaminated with organic material that may be present inside the flowcell.

4.1.1 Zero Standard Solution

High purity water is used for the zero standard solution and must be as fresh as possible. If storage is unavoidable, use a glass container to prevent contamination. Some plastics, for example polythene and polypropylene, may be acceptable, but regardless of material, the container must be meticulously clean and kept solely for the purpose of storing the zero standard solution.

Note. The high purity water used for the zero solution and for diluting the span standard solution must contain less than $50\mu\text{g l}^{-1}$ TOC. It is recommended that the water is obtained from purification systems comprising reverse osmosis and de-ionization units but freshly distilled water can also be used. De-ionized water is not recommended as it often contains significant levels of organics.

4.1.2 Span Standard Solution

The span standard solution is prepared from potassium hydrogen phthalate ($\text{KOOOC}_6\text{H}_4\text{COOH}$, carbon content = 47.05 %), Analytical Reagent grade and high purity water.

To prepare a $1000\text{mg l}^{-1}\text{C}$ carbon stock standard solution:

1. Dry $2.125\pm 0.005\text{g}$ of potassium hydrogen phthalate at 120°C for 2 hours.
2. Dissolve the dried potassium hydrogen phthalate in 500ml high purity water.
3. make up to 1 litre in a volumetric flask.

The solution may be stored in a glass bottle in a refrigerator, without freezing, for up to 12 months.

Working standard solutions for system calibration must be freshly prepared from the stock standard when required. Dilute the stock solution with high purity water. Discard the working standard solution after use.

7320 100 Low Range Sensor – $10\text{mg l}^{-1}\text{C}$:

Dilute 10ml of the stock standard solution to 1 litre high purity water in a volumetric flask.

7320 200 High Range Sensor – $50\text{mg l}^{-1}\text{C}$:

Dilute 50ml of the stock standard solution to 1 litre high purity water in a volumetric flask.

4.1.3 Calibration Checks

The sensor's emitter module contains an optical system with very stable electronics that eliminate electronic drift, therefore, routine calibration is normally unnecessary. However, it may be necessary to check system accuracy, particularly after cleaning the flowcell.

A calibration check is carried out by filling the flowcell with the Zero and Span standard solutions and observing the readings in the *Operating Page* – see Section 2.3.

The solutions are poured in from the top of the flowcell.

7320 100 Low Range Sensor:

Remove the wiper module, fill the flowcell and refit the wiper module.

7320 200 High Range Sensor:

Remove the filler plug on top of the flowcell and use the funnel provided.

4.2 Sensor Calibration

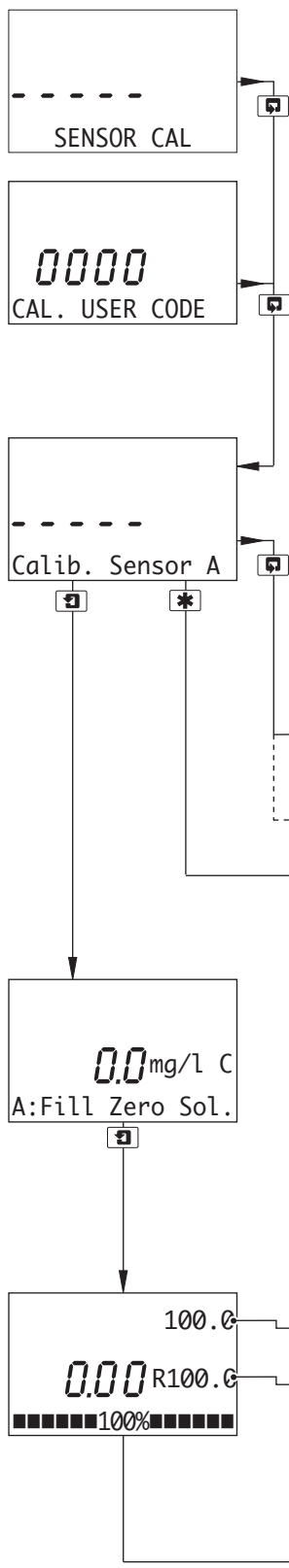

Sensor Calibration

Sensor Calibration Security Code

Note. This frame is displayed only if **Alter Cal. Code** is not set to zero – see Section 5.8.

Enter the required code number (between 0000 and 19999) to gain access to the sensor calibration pages. If an incorrect value is entered, access to the calibration pages is prevented and the display reverts to the **SENSOR CAL.** frame.

Calibrate Sensor A

Note. A full calibration comprises a zero and a span calibration. However, it is possible to carry out zero and span calibrations independently by aborting the one that is not required (press the **F1** key to initiate the calibration and press it again before the calibration is complete). If either calibration is aborted, **A:Cal Incomplete** is shown on the lower display line (see next page). The **Cals** logbook records the calibration type as zero (**Z**), span (**S**) or both (**ZS**) – see Section 3.6, page 12.

Calib. Sensor B Sensor B calibration (dual input monitors only) is identical to Sensor A calibration.

SENSOR CAL Single input monitors only – return to main menu.

SECURITY CODE **Alter Sec. Code** not set to zero (Section 5.8) – see Section 5.1.

CONFIG. DISPLAY **Alter Sec. Code** set to zero (Section 5.8) – see Section 5.2.

Zero Calibration

Fill the flowcell with high purity water – see Section 4.1.1.

Press the **F1** key to initiate calibration.

Note. If the **F1** key is pressed again at any time before zero calibration is complete, the display advances automatically to the **A:Fill Span Sol.** frame.

Raw Output from Sensor

Organics total signal } These values equate to the percentage light transmission through the sample.
Reference total signal }

As calibration proceeds, a progress indicator appears in the lower display line. After 3 minutes, the lower display line shows **■■■■■■100%■■■■■■**, the display then advances automatically to the next frame.

A:Fill Span Sol. Continued on next page.

...4.2 Sensor Calibration

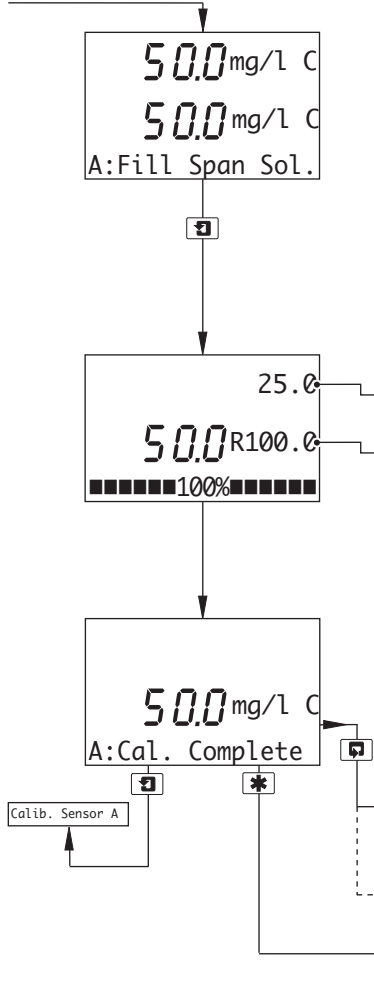

Span Calibration

Fill the flowcell with the required span standard calibration solution – see Section 4.1.2.

Press the key to initiate calibration.

Note. If the key is pressed again at any time before span calibration is complete, **A:Cal Incomplete** is shown on the lower display line (see below).

Raw Output from Sensor

Organics total signal } These values equate to the percentage light transmission through the sample.
Reference total signal }

As calibration proceeds, a progress indicator appears in the lower display line. After 3 minutes, the lower display line shows 100%, the display then advances automatically to the next frame.

Calibration Completed

A message is displayed at the end of calibration:

- A:Cal Complete** – calibration successful
- A:Cal Incomplete** – zero and/or span calibration aborted

- Calib. Sensor B** Sensor B calibration (dual input monitors only) is identical to Sensor A calibration.
- SENSOR CAL** Single input monitors only – return to main menu.
- SECURITY CODE** **Alter Sec. Code** not set to zero (Section 5.8) – see Section 5.1.
- CONFIG. DISPLAY** **Alter Sec. Code** set to zero (Section 5.8) – see Section 5.2.

5 PROGRAMMING

5.1 Security Code



→ CONFIG. DISPLAY See Section 5.2.

Note. This frame is displayed only if **Alter Sec. Code** is not set to zero – see Section 5.8.

Enter the required code number (between 0000 and 19999) to gain access to the configuration pages. If an incorrect value is entered, access to the configuration pages is prevented and the display reverts to the *Operating Page* – see Section 2.3.

5.2 Configure Display

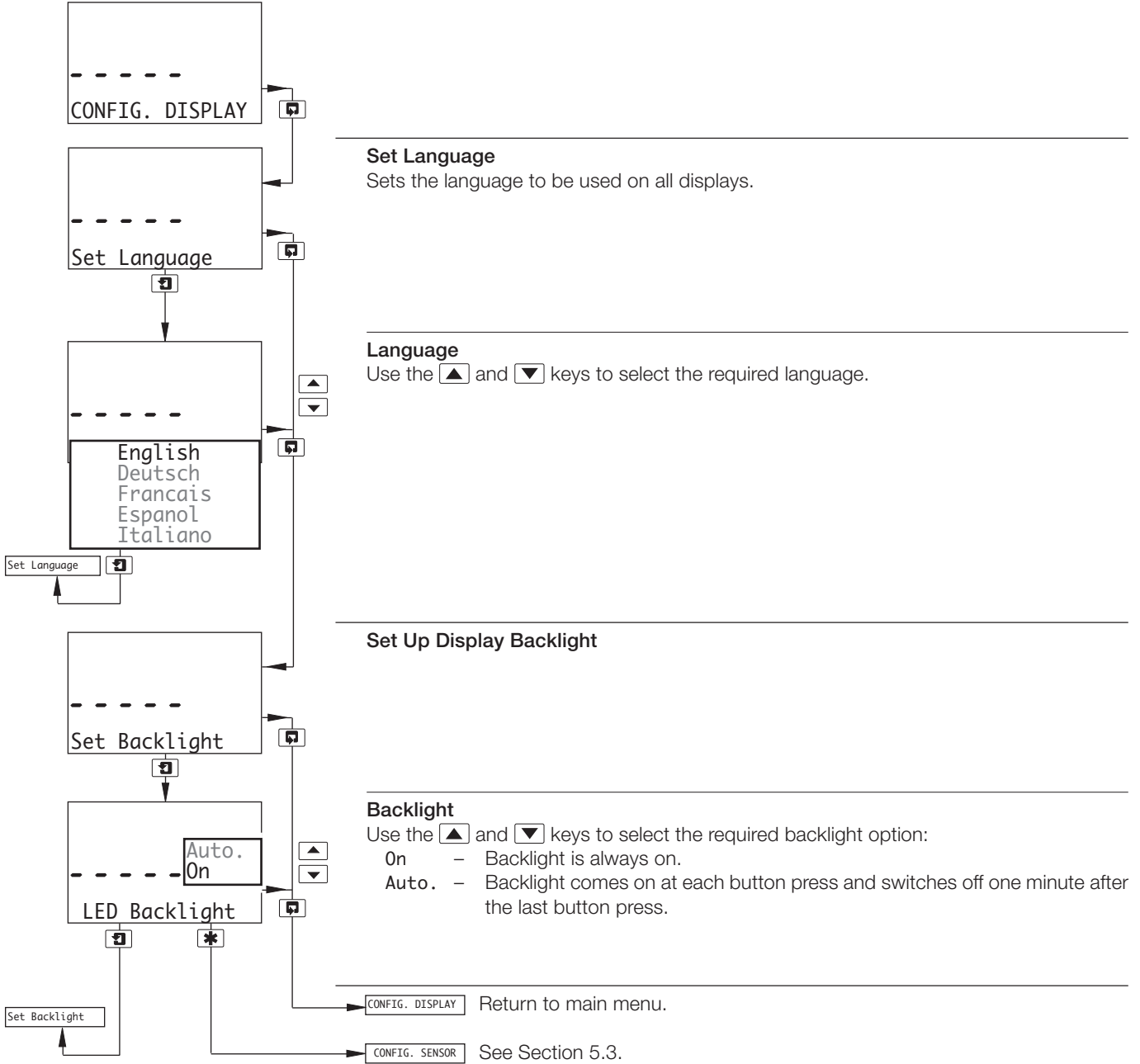

5.3 Configure Sensors

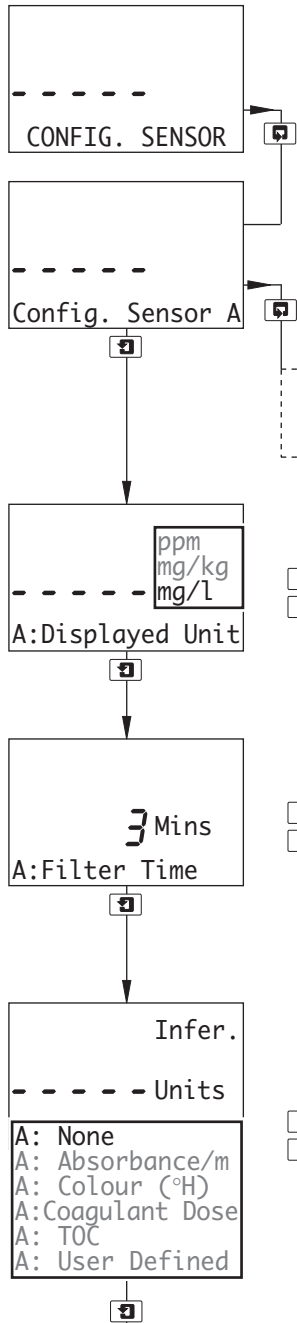

Configure Sensor A

Config. Sensor B Sensor B configuration (dual input monitors only) is identical to Sensor A configuration.

CONFIG. SENSOR Single input monitors only – return to main menu.

Displayed Units

Select the units required for display:



- mg/l – milligrammes per litre
- mg/kg – milligrammes per kilogramme
- ppm – parts per million

Filter Time

To prevent short term variations in reading, typically due to air bubbles in the sample, the sensor signal can be configured to provide an average reading over a set period of time. Set the required filter time, between 1 and 10 minutes in 1 minute increments.



Note. Use the lowest value that provides an acceptably stable reading. The default value is 3 minutes.

Inferred Units

The monitor is calibrated and operates in mg/l⁻¹ dissolved organic carbon but can be configured to display values in inferred units:



- None – The monitor displays all sensor readings in mg/l⁻¹.
- Absorbance/m – A conversion factor of 1.5 is applied to the sensor signal.
- Colour (°H) – displayed in °H
- Coagulant Dose – displayed in mg/l⁻¹
- TOC – displayed in mg/l⁻¹
- User Defined – The required units are entered in the **A: User Defined** frame (see next page) and the conversion factor set in the **A:Conv. Factor** frame (see next page) is applied to the sensor signal.

Notes.

- With the exception of **Absorbance/m**, the conversion factor must be determined by laboratory analysis of the actual sample.
- When inferred units are selected for display, all values for alarm settings, current output ranges and calibration values remain in mg/l⁻¹ dissolved organics but the equivalent inferred unit is displayed.

A: User Defined **Infer. Units** set to **User Defined** – continued on next page.

A:Conv. Factor **Infer. Units** set to **Colour (°H)**, **Coagulant Dose** or **TOC** – continued on next page.

A:Clean Interval **Infer. Units** set to **None** or **Absorbance/m** – continued on next page.

...5.3 Configure Sensors

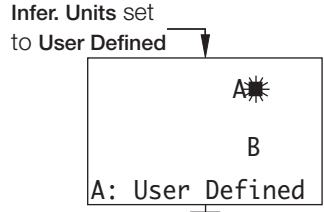

User Defined Units

Enter the units to be displayed in the operating pages.

A flashing cursor is shown in the upper display line. Press the and keys until the first character of the required units is shown in the center display line. Press the key to enter the character into the upper display line and advance the cursor one character. Repeat the process for the remaining characters to a maximum of 6.

Press the key to save the user defined units and advance to the next frame.

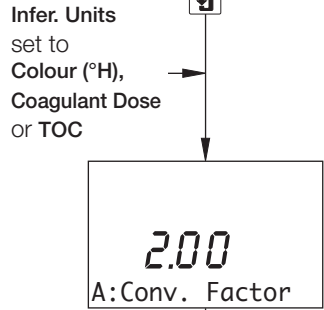

Conversion Factor

Enter the conversion factor, determined by laboratory analysis, to be applied to the sensor signal for the chosen inferred units, between 0.10 and 9.00 in 0.01 increments.

Notes.

- It is assumed that the applied conversion factor remains constant.
- The monitor measures absorbance of dissolved organics at 254nm only. If the conversion factor changes, the monitor readings may not agree with independent laboratory results until a new conversion factor is determined and entered.

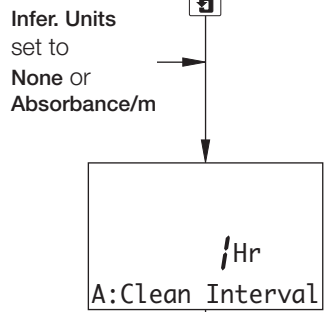

Cleaning Interval

Select the required interval between automatic cleaning operations:
15, 30 or 45 minutes or 1, 2, 4, 6, 12 or 24 hours.

Note. The cleaning interval setting is determined by plant experience. Check the condition of the flowcell and optical windows at appropriate intervals to determine the optimum setting.

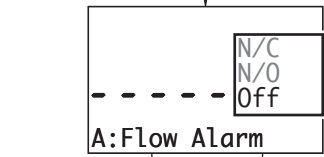

Flow Alarm

Set the input switch contact condition required during normal operations:

- Off – Input switch contact disabled
- N/O – Normally open
- N/C – Normally closed

Config. Sensor B Sensor B configuration (dual input monitors only) is identical to Sensor A configuration.

CONFIG. SENSOR Single input monitors only – return to main menu.

CONFIG. ALARMS See Section 5.4.

5.4 Configure Alarms

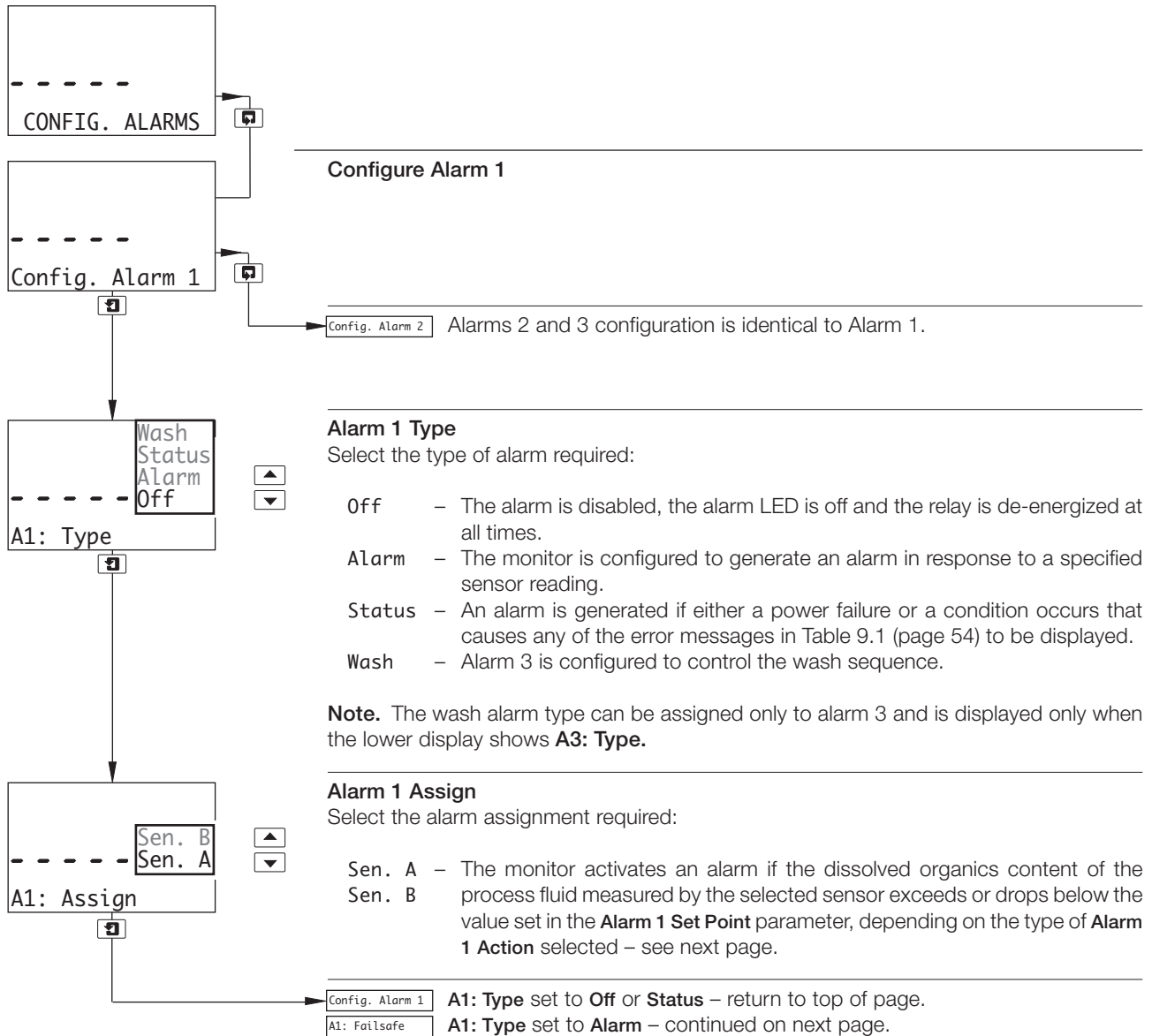

...5.4 Configure Alarms

A1: Type

set to Alarm

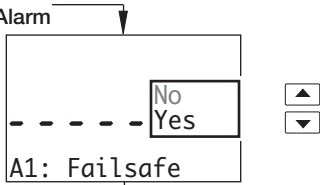

Alarm 1 Failsafe

Select **Yes** to enable failsafe action, otherwise select **No**. Refer to Figs. 5.1 to 5.5 (page 22).

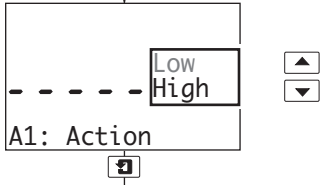

Alarm 1 Action

Select the alarm action required, **High** or **Low**. Refer to Figs. 5.1 to 5.5 (page 22).

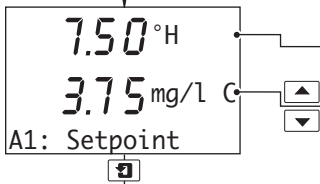

Alarm 1 Set Point

Inferred units. Displayed only if **Infer. Units** set to anything other than **None** – see Section 5.3.

Set the alarm set point to the required value. High range between 0.0 and 100.0 in 0.1 increments and low range between 0.00 and 20.00 in 0.01 increments.

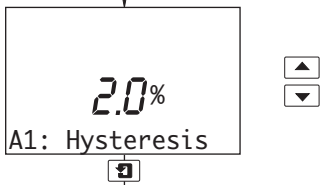

Alarm 1 Hysteresis

A differential set point can be defined between 0 and 5% of the alarm set point value. Set the required hysteresis in 0.1% increments. Refer to Figs. 5.1 to 5.5 (page 22).

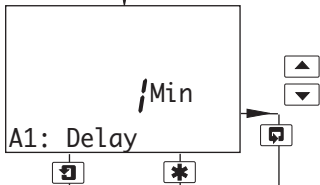

Alarm 1 Delay

If an alarm condition occurs, activation of the relays and LEDs can be delayed for a specified time period. If the alarm clears within the period, the alarm is not activated.

Set the required delay, in the range 0 to 100 minutes in 1 minute increments. Refer to Figs. 5.1 to 5.5 (page 22).

Config. Alarm 1

Config. Alarm 2

Alarms 2 and 3 configuration is identical to Alarm 1.

CONFIG. OUTPUTS

See Section 5.5.

...5.5 Configure Alarms

5.5.1 Wash Cycle Configuration (applicable only to Alarm 3)

A3: Type
set to Wash

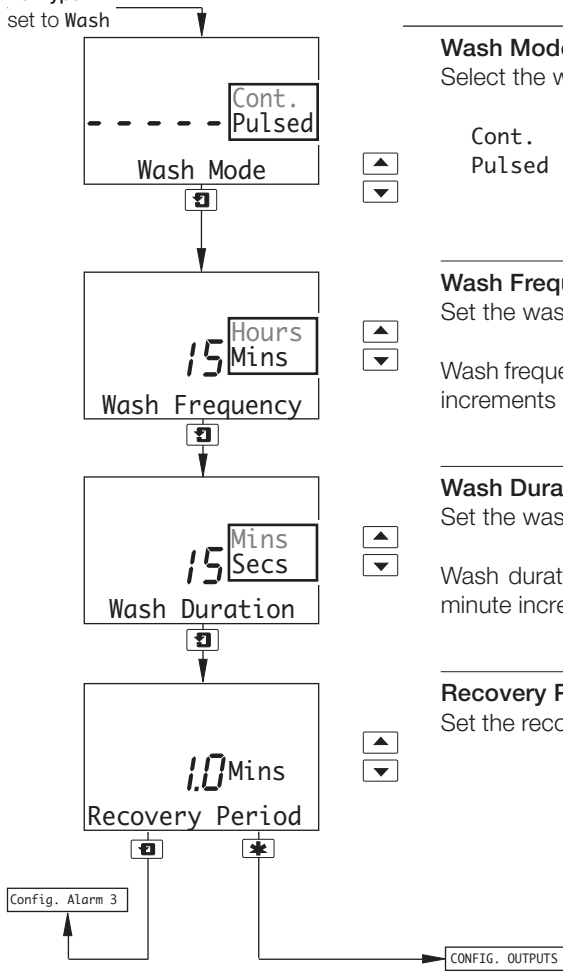

Wash Mode

Select the wash mode required.

- Cont. - (continuous) the relay remains energized for the wash duration
- Pulsed - the relay is switched on and off every second for the duration of the wash, - see Fig. 5.1

Wash Frequency

Set the wash frequency required.

Wash frequency is set in 15 minute increments between 15 and 45 minutes, then in 1 hour increments between 1 and 24 hours.

Wash Duration

Set the wash duration required.

Wash duration is set in 15 second increments between 15 and 45 seconds, then in 1 minute increments between 1 and 10 minutes.

Recovery Period

Set the recovery period required, between 0.5 and 5.0 minutes in 0.5 minute increments.

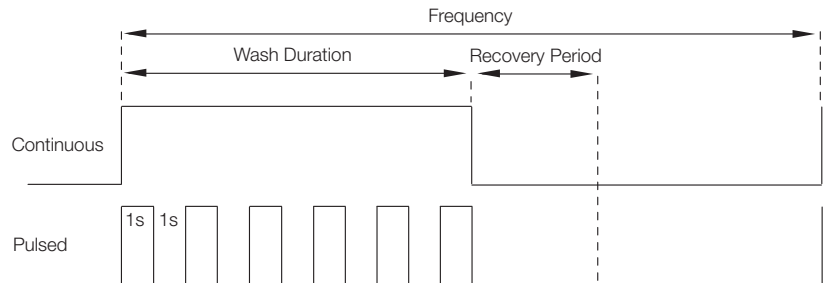
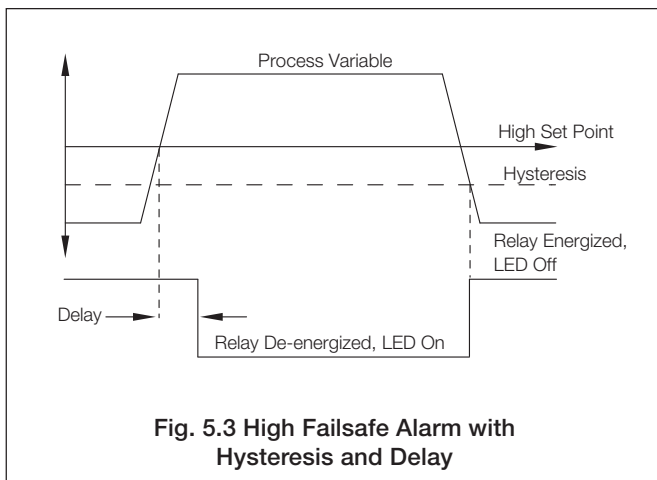
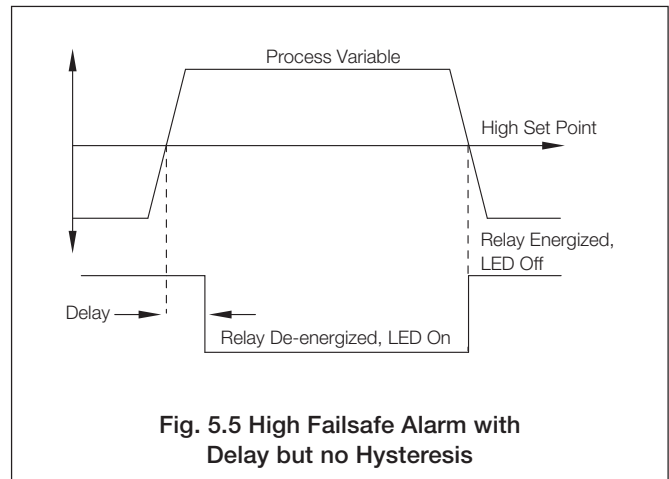
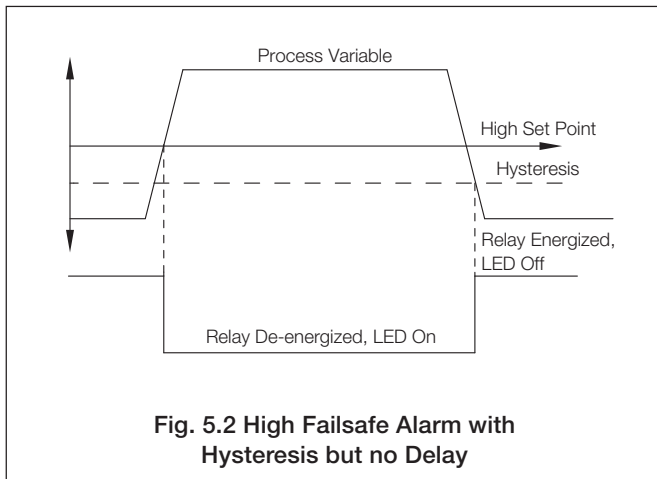
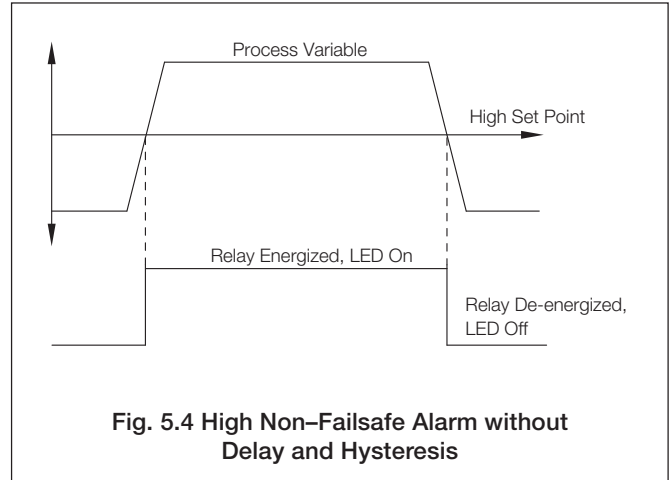
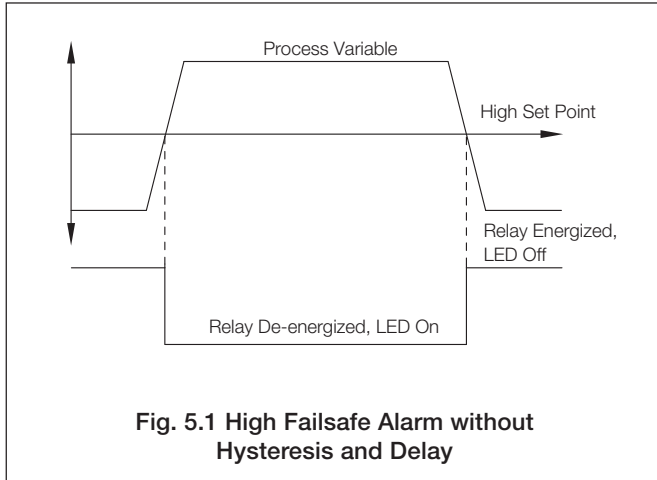

Fig. 5.1 Pulsed and Continuous Wash Cycles

...5 PROGRAMMING

...5.4 Configure Alarms

Note. The following examples illustrate **High Alarm Actions**, i.e. the alarm is activated when the process variable exceeds the defined set point. **Low Alarm Actions** are the same except the alarm is activated when the process variable drops below the defined set point.



5.5 Configure Outputs

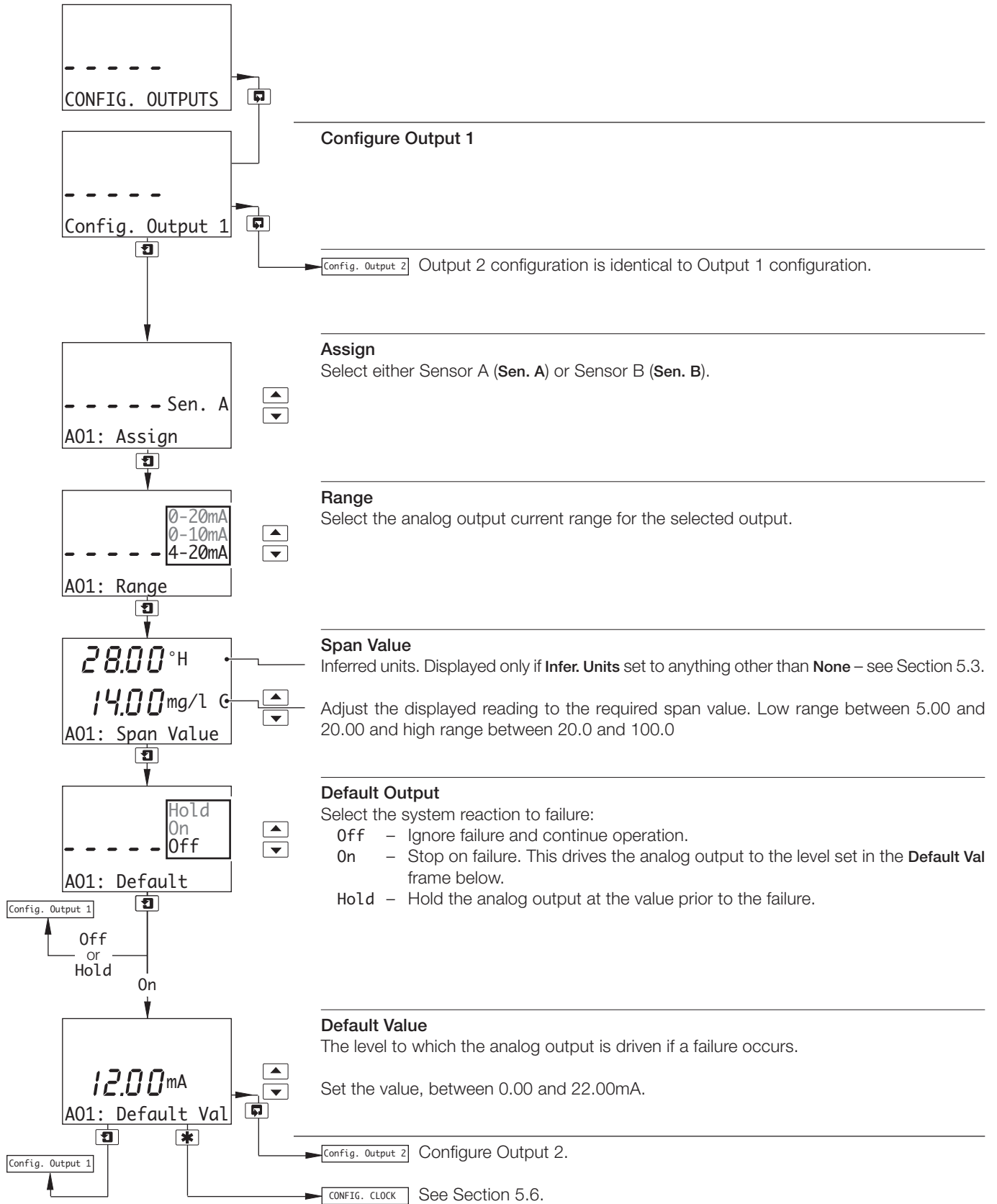

5.6 Configure Clock

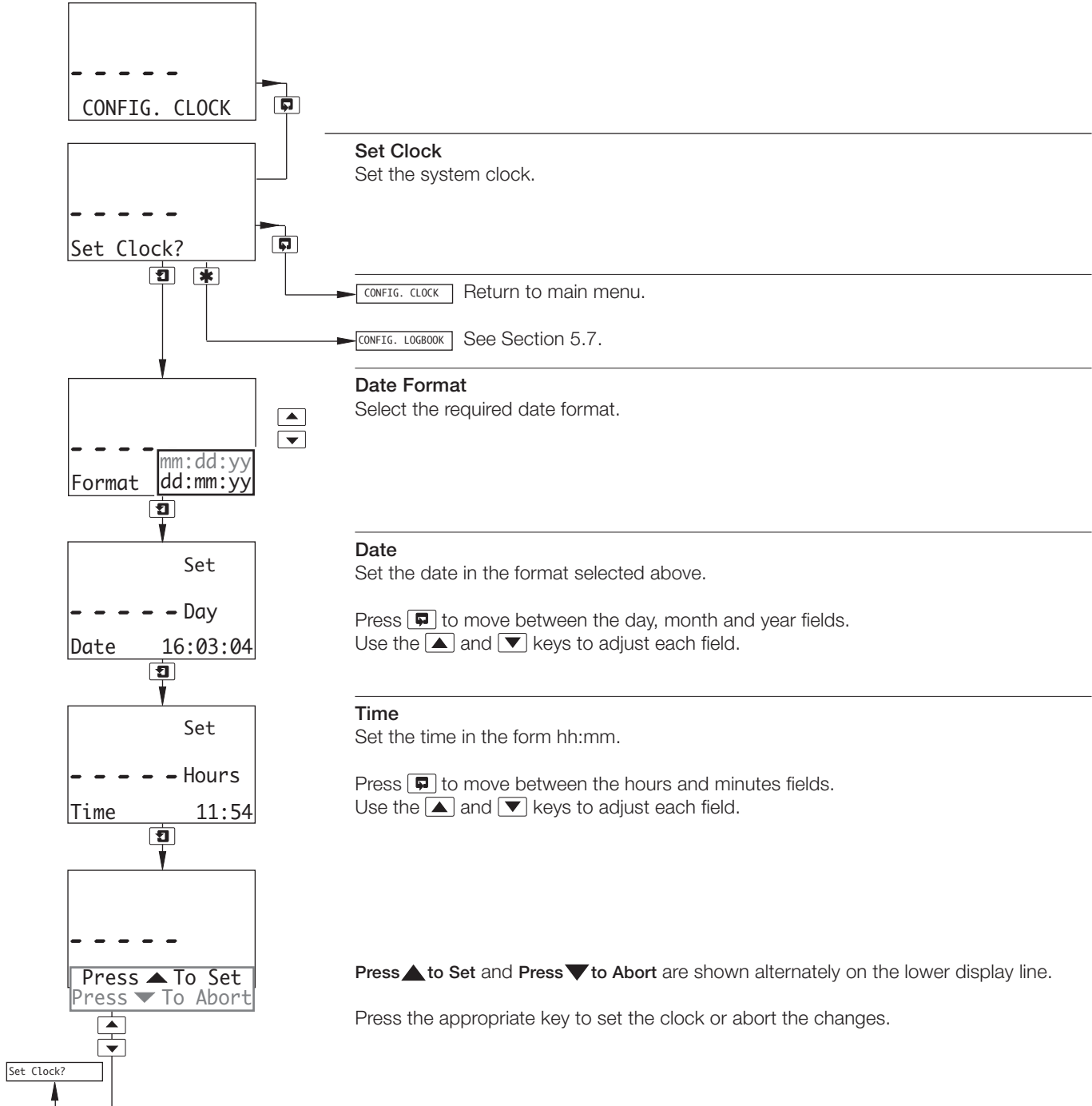

5.7 Configure Logbook

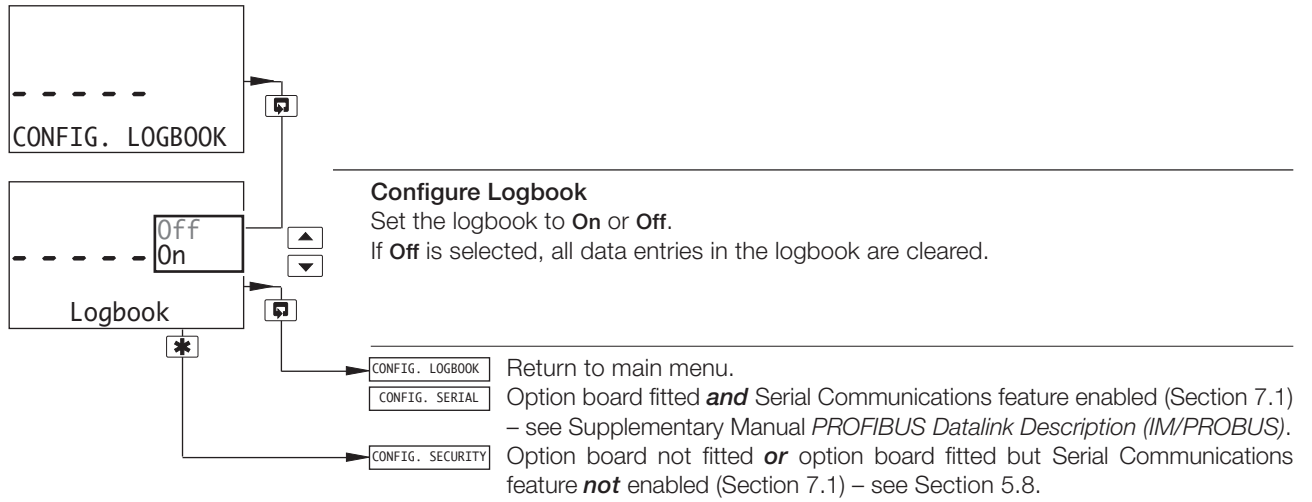

5.8 Configure Security

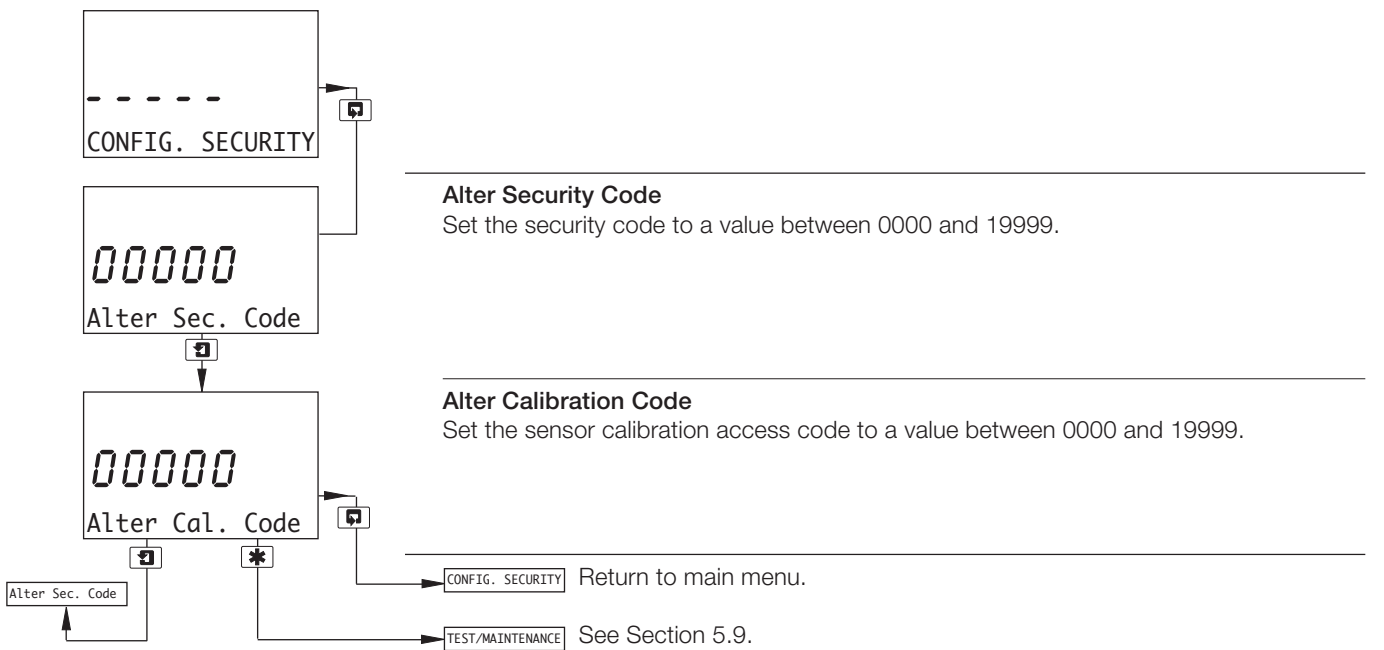

5.9 Test Outputs and Maintenance

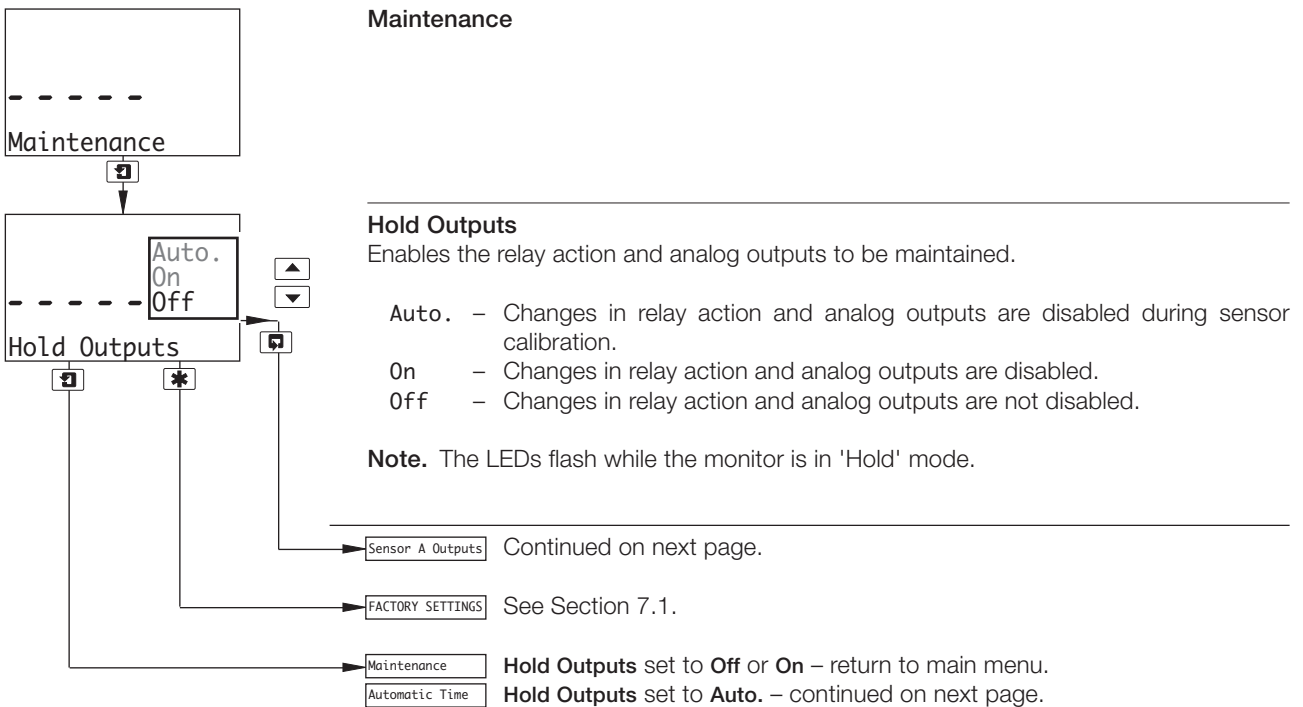
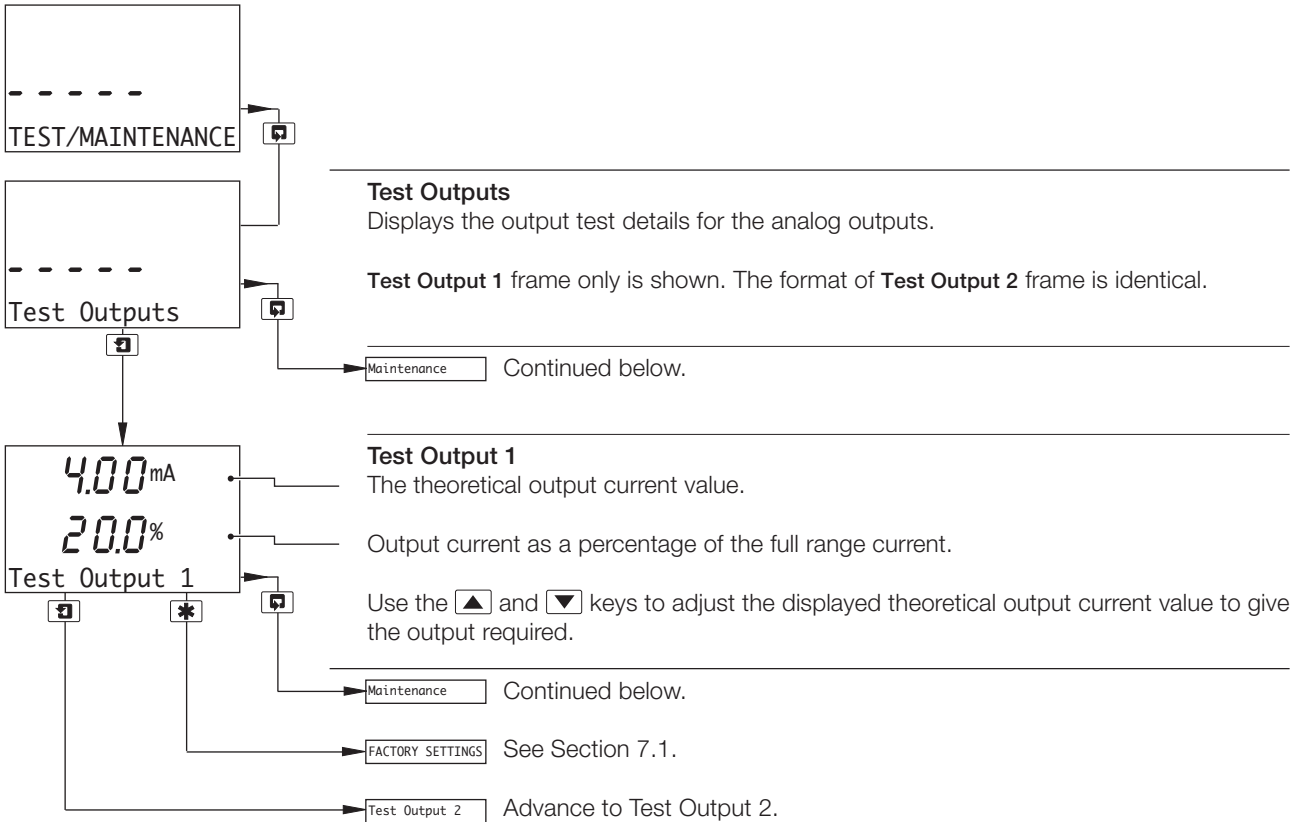

...5.9 Test Outputs and Maintenance

Hold Outputs
set to Auto.

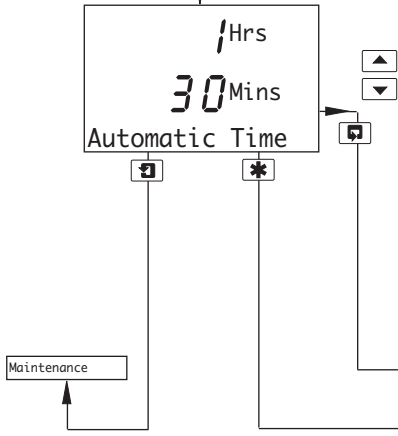

Automatic Time

If required, set a time period between 1 and 6 hours, in 30 minute increments, for which the outputs are held when **Hold Outputs** is set to **Auto**.

At the default setting of **Off**, changes in relay action and analog outputs are disabled during sensor calibration and enabled automatically at the end of the procedure.

If a time is set, changes in relay action and analog outputs are disabled during sensor calibration but, if the calibration is not completed within the set time, the calibration is aborted, the display returns to the *Operating Page* and **CAL. ABORTED** is displayed.

Sensor A Outputs Continued below.

FACTORY SETTINGS See Section 7.1.

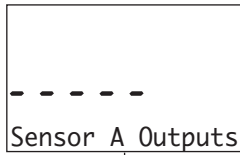

Sensor A Outputs

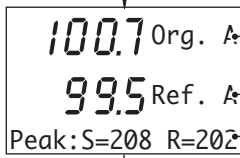

Organics and Reference Signals

Organics total signal } These values equate to the percentage light transmission through the sample.
Reference total signal }

The peak values of the light pulse generated by the strobe lamp.

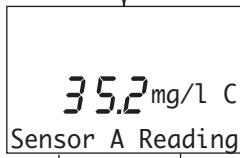

Instantaneous Reading

Internal damping function disabled – display shows instantaneous reading from sensor.

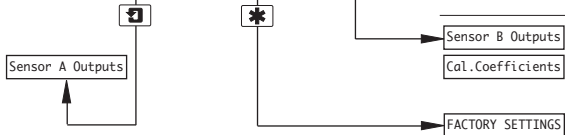

Sensor B Outputs Sensor B outputs (dual input monitors only) are identical to Sensor A outputs.
Cal. Coefficients Single input monitor – continued on next page.

FACTORY SETTINGS See Section 7.1

...5.9 Test Outputs and Maintenance

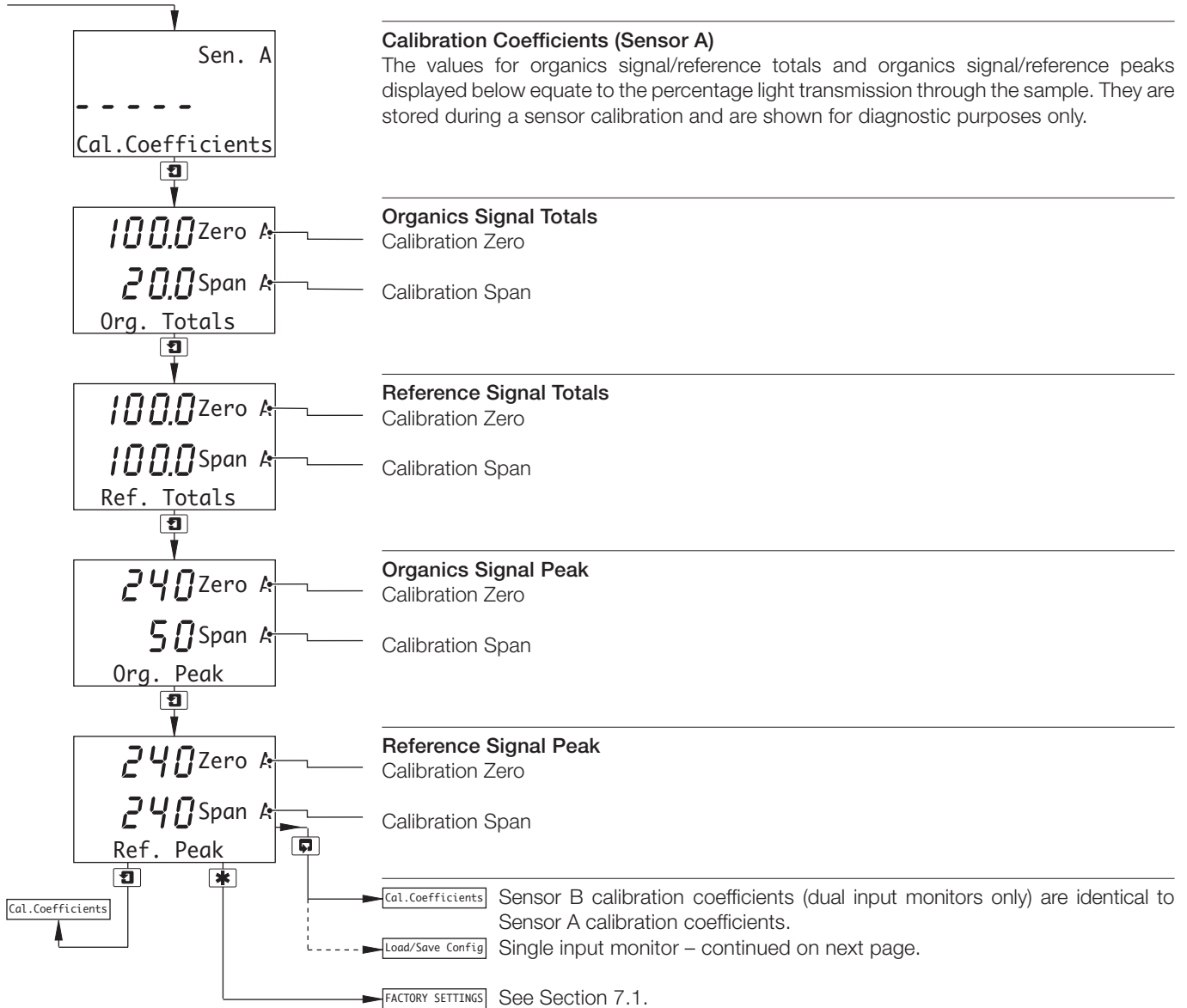

...5.9 Test Outputs and Maintenance

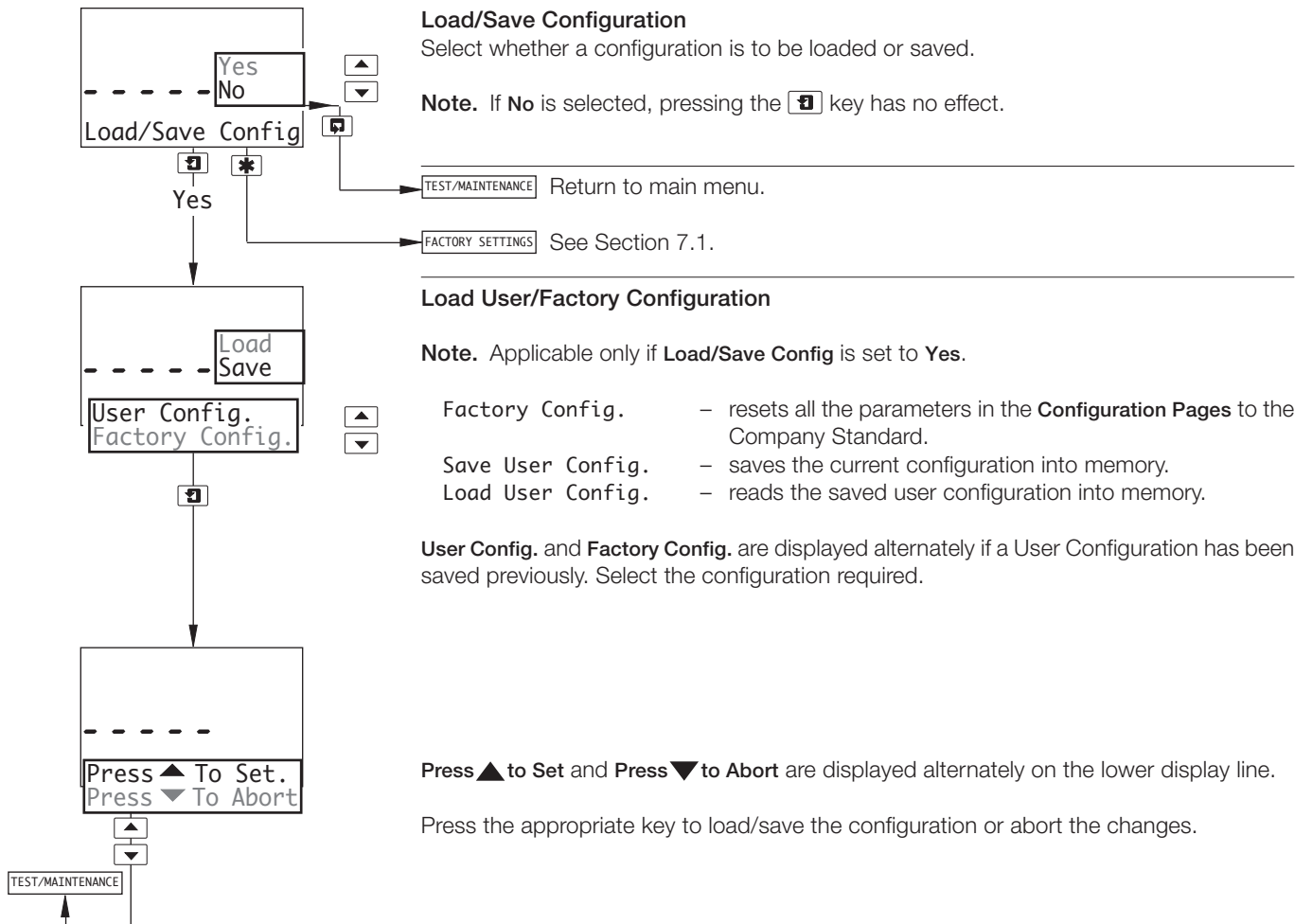

6 INSTALLATION

6.1 Siting Requirements – Fig. 6.1

6.1.1 Transmitter

Notes.

- Mount in a location free from excessive vibration.
- Mount away from harmful vapours and/or dripping fluids.
- Where possible, mount the transmitter at eye level to allow an unrestricted view of the front panel displays and controls.

6.1.2 Sensor

Notes.

- The sensor is supplied fitted with mounting brackets.
- Secure the sensor to a suitable vertical surface in a location that enables easy access for maintenance and calibration.

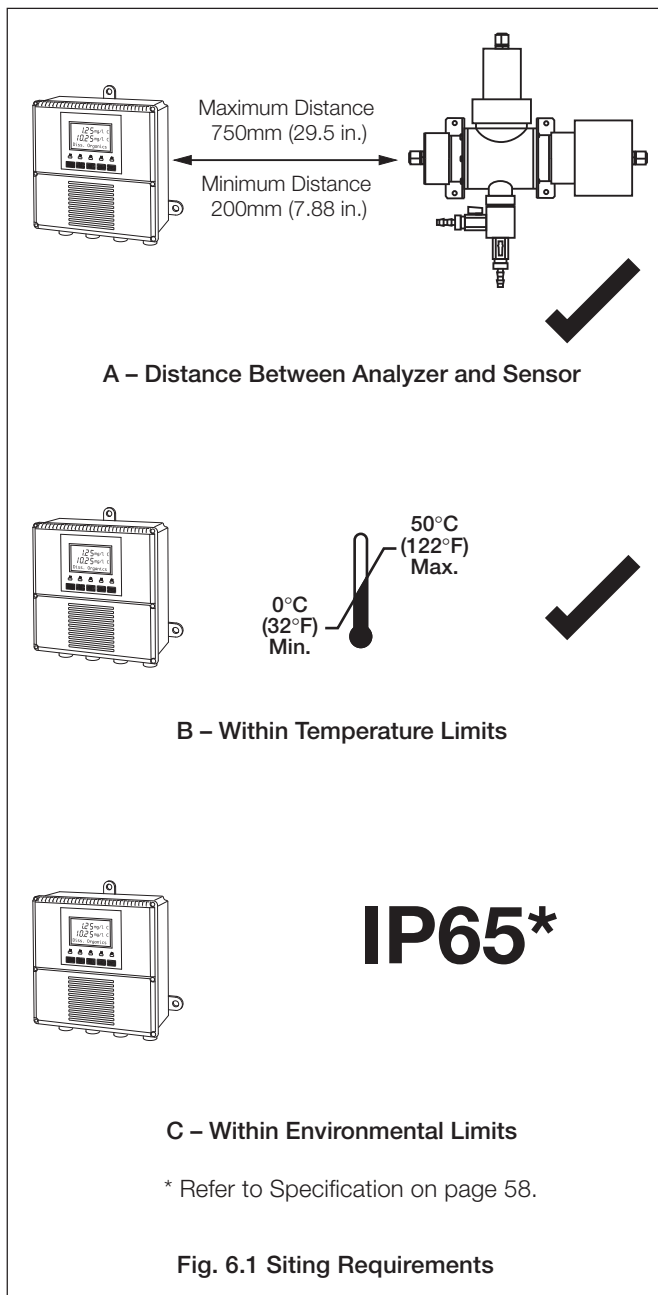

6.2 Mounting the Transmitter – Figs. 6.2 and 6.3

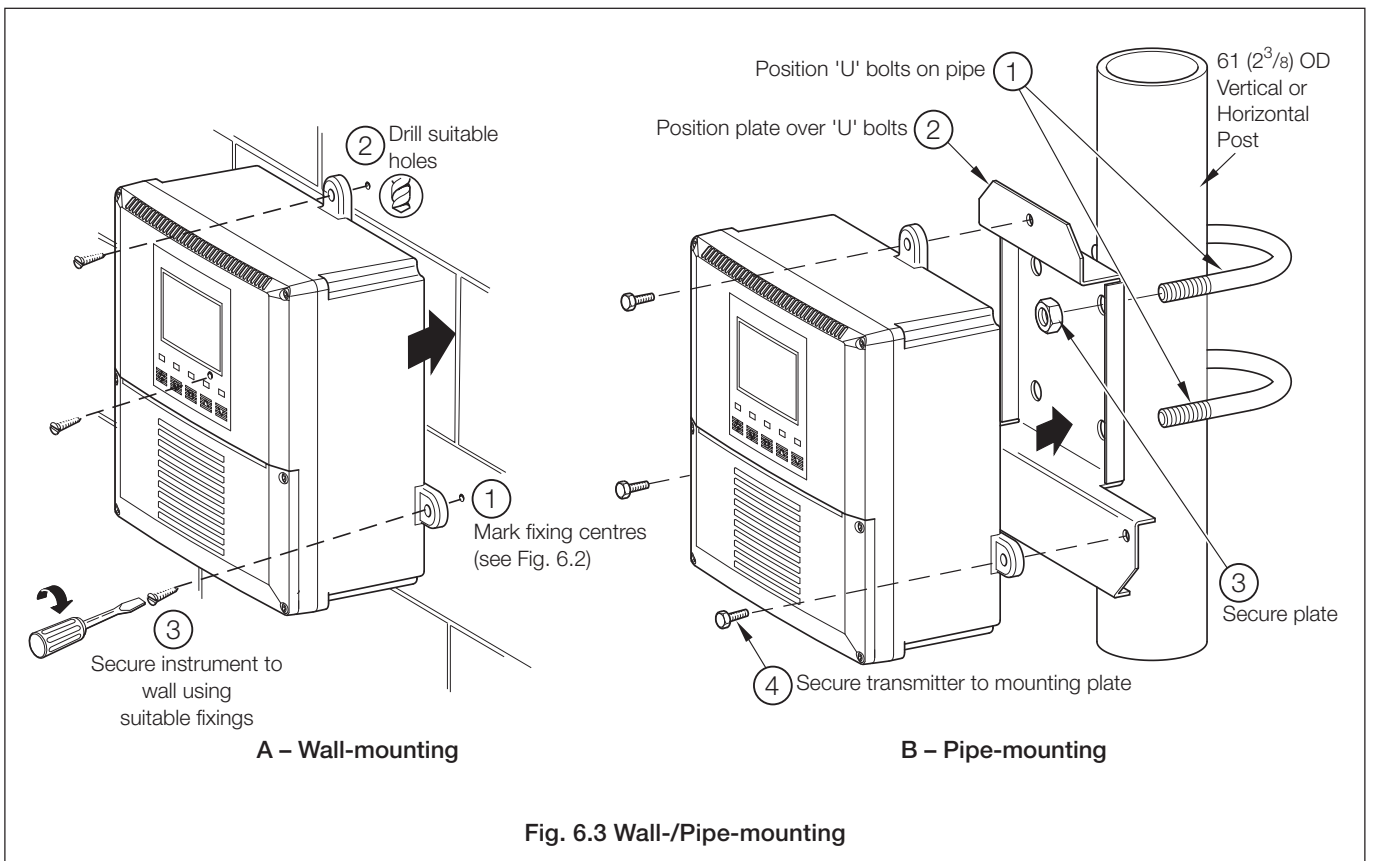
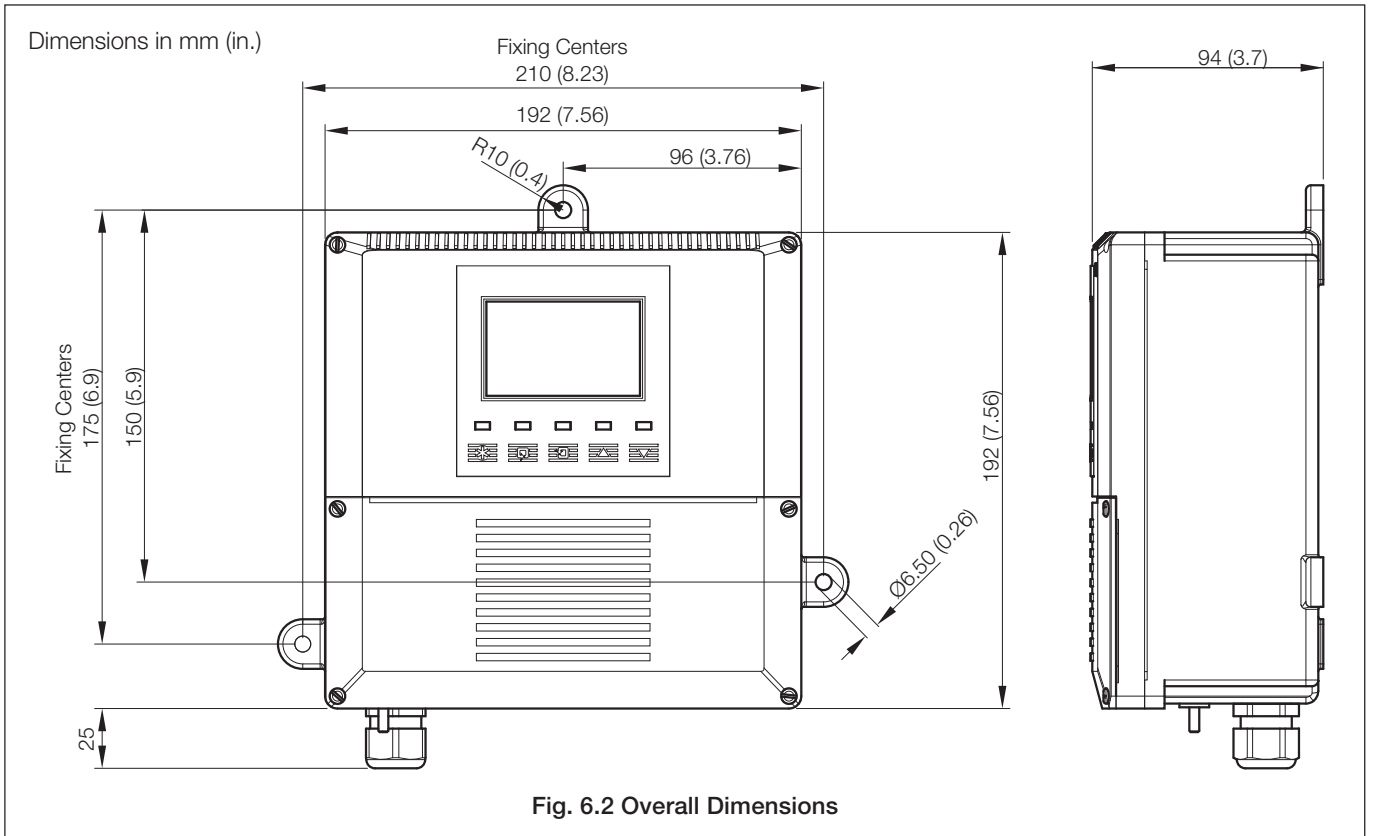

...6 INSTALLATION

6.3 Installing the Sensor – Figs. 6.4 and 6.5

Notes.

- Use flexible plastic or rigid PVC, polypropylene or metal connecting pipework, depending on the installation.
- Fit isolating valves to enable removal of the sensor.

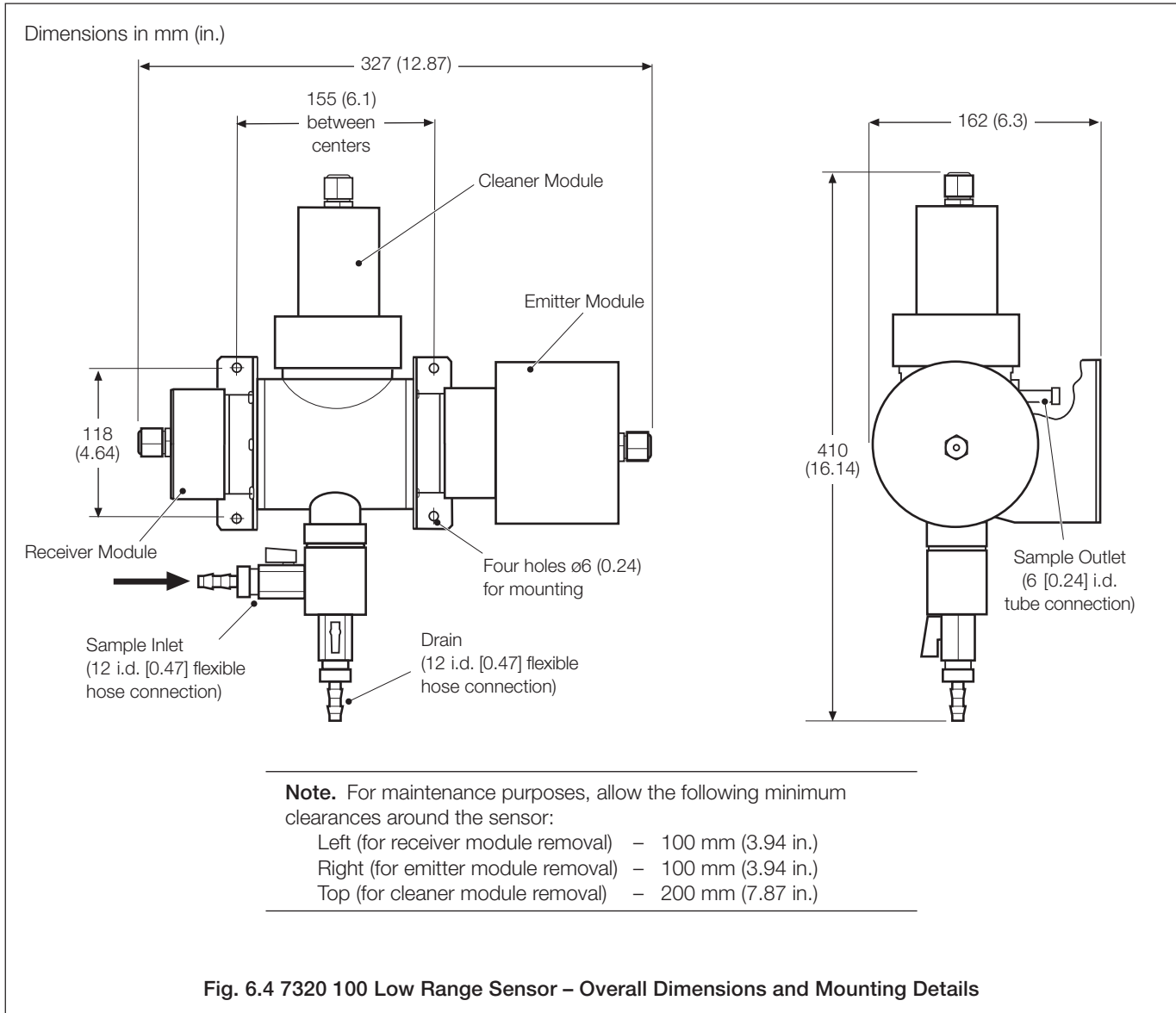

...6.3 Installing the Sensor – Figs. 6.4 and 6.5

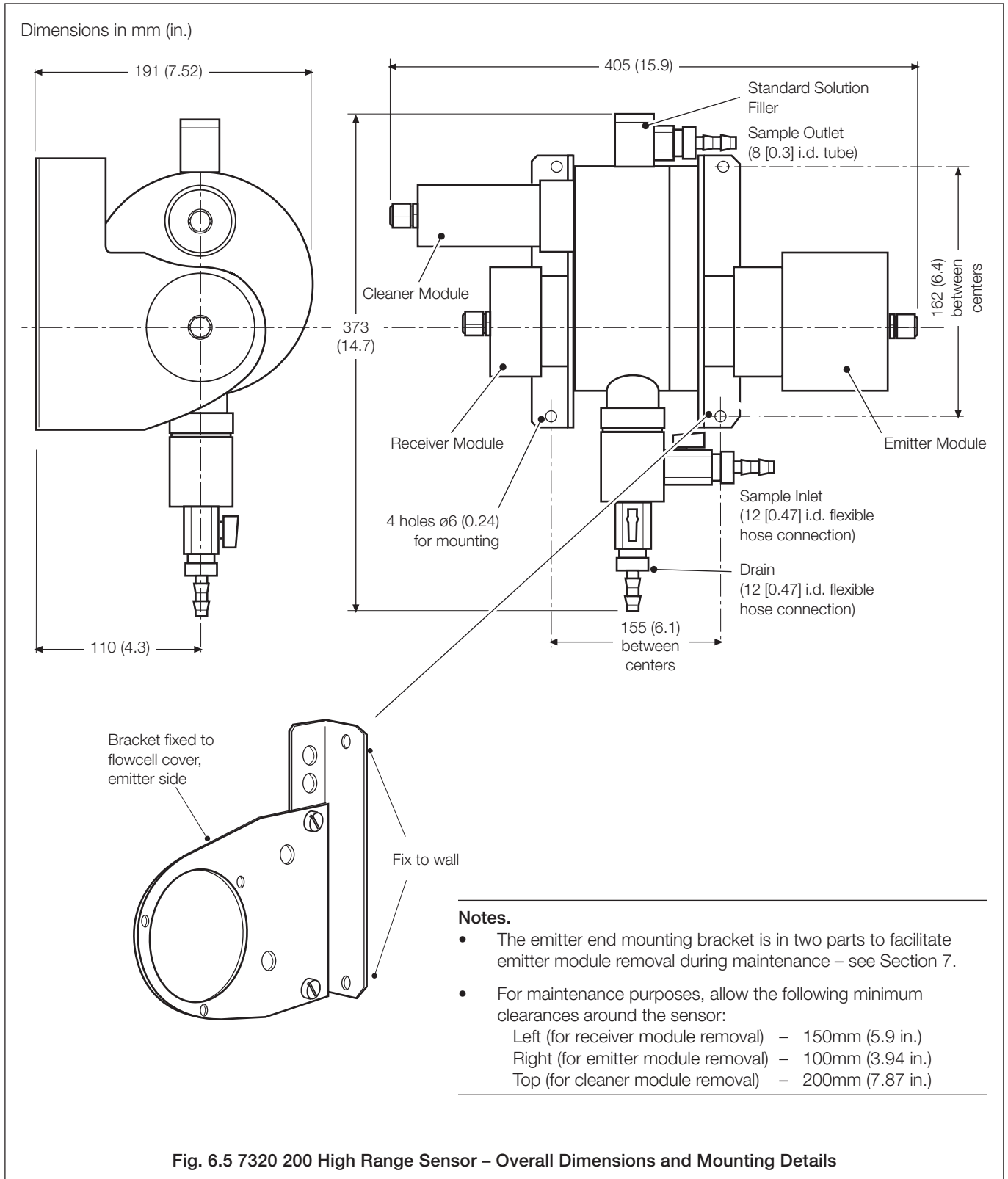
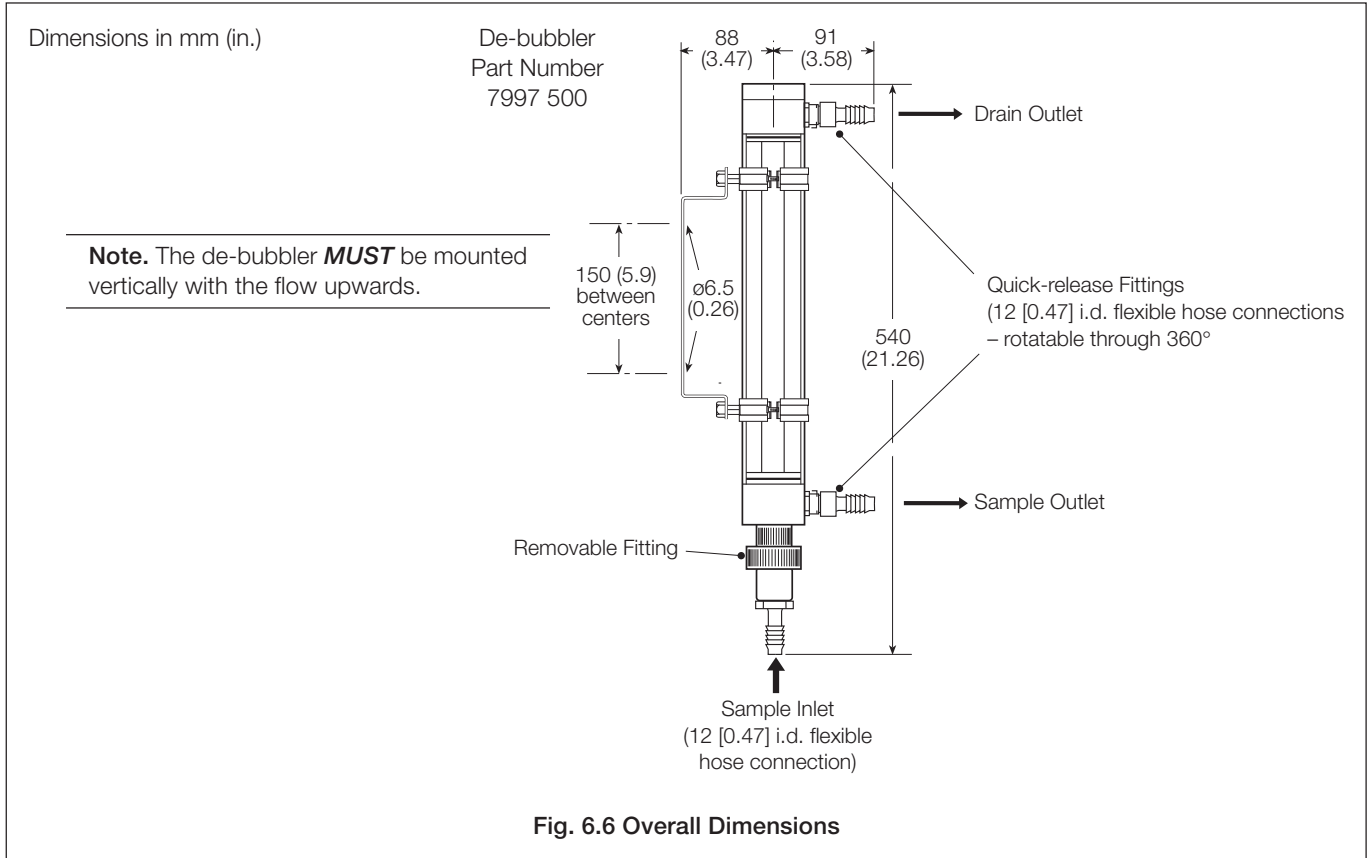
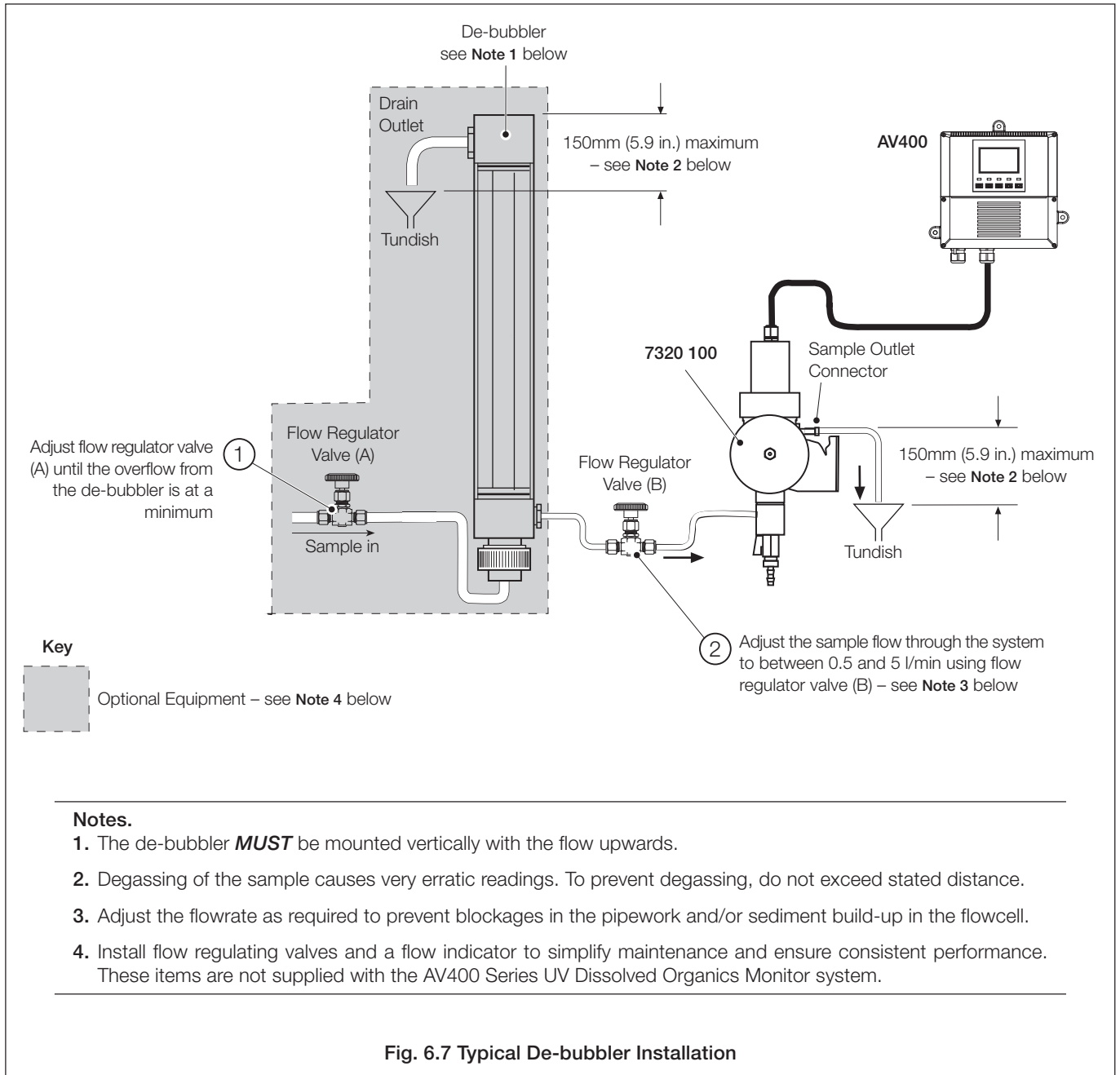

Fig. 6.5 7320 200 High Range Sensor – Overall Dimensions and Mounting Details

6.4 Installing the Optional De-bubbler – Figs. 6.6 and 6.7



...6.4 Installing the Optional De-bubbler – Figs. 6.6 and 6.7



6.5 Electrical Connections



Warnings.

- The transmitter is not fitted with a switch therefore a disconnecting device such as a switch or circuit breaker conforming to local safety standards must be fitted to the final installation. It must be fitted in close proximity to the transmitter within easy reach of the operator and must be marked clearly as the disconnection device for the transmitter.
- Remove all power from supply, relay and any powered control circuits and high common mode voltages before accessing or making any connections.
- The power supply earth (ground) **must** be connected to reduce the effects of RFI interference and ensure the correct operation of the power supply interference filter.
- The power supply earth (ground) must be connected to the earth (ground) stud on the analyzer case – see Fig. 6.9.
- Use cable appropriate for the load currents. The terminals accept cables from 20 to 14 AWG (0.5 to 2.5mm²) UL Category AVLV2.
- The monitor conforms to Mains Power Input Insulation Category III. All other inputs and outputs conform to Category II.
- All connections to secondary circuits must have basic insulation.
- After installation, there must be no access to live parts e.g. terminals.
- Terminals for external circuits are for use only with equipment with no accessible live parts.
- The relay contacts are voltage-free and must be appropriately connected in series with the power supply and the alarm/control device which they are to actuate. Ensure that the contact rating is not exceeded. Refer also to Section 6.5.1 for relay contact protection details when the relays are to be used for switching loads.
- Do not exceed the maximum load specification for the selected analog output range.
The analog output is isolated, therefore the –ve terminal must be connected to earth (ground) if connecting to the isolated input of another device.
- If the monitor is used in a manner not specified by the Company, the protection provided by the equipment may be impaired.
- All equipment connected to the transmitter's terminals must comply with local safety standards (IEC 60950, EN61010-1).

USA and Canada Only

- The supplied cable glands are provided for the connection of signal input and ethernet communication wiring ONLY.
- The supplied cable glands and use of cable / flexible cord for connection of the mains power source to the mains input and relay contact output terminals is not permitted in the USA or Canada.
- For connection to mains (mains input and relay contact outputs), use only suitably rated field wiring insulated copper conductors rated min. 300 V, 14 AWG 90C. Route wires through suitably flexible conduits and fittings.

Notes.

- Four earth (ground) – studs are fitted to the transmitter case for bus-bar earth (ground) connection – see Fig. 6.10.
 - Always route sensor signal cables and mains-carrying/relay cables separately, ideally in earthed (grounded) metal conduit.
 - The screens of the sensor's emitter, receiver and cleaner cables **must** be enclosed in yellow/green sleeving and connected to the earth (ground) stud fitted to the transmitter case closest to the cable's entry point – see Fig. 6.10.
 - Ensure that cables enter the transmitter through the glands nearest the appropriate screw terminals and are short and direct. Do not tuck excess cable into the terminal compartment.
 - Ensure that the NEMA4X/IP66 rating is not compromised when using cable glands, conduit fittings and blanking plugs/bungs (M20 holes). The M20 glands accept cable of between 5 and 9mm (0.2 and 0.35 in.) diameter.
-

...6.5 Electrical Connections

6.5.1 Relay Contact Protection and Interference Suppression – Fig. 6.8

If the relays are used to switch loads on and off, the relay contacts can become eroded due to arcing. Arcing also generates radio frequency interference (RFI) that can result in monitor malfunctions and incorrect readings. To minimize the effects of RFI, arc suppression components are required; resistor/capacitor networks for AC applications or diodes for DC applications. These components can be connected either across the load or directly across the relay contacts. The RFI components must be fitted to the relay terminal block along with the supply and load wires – see Fig 6.8.

For **AC applications** the value of the resistor/capacitor network depends on the load current and inductance that is switched. Initially, fit a 100R/0.022 μ F RC suppressor unit (part no. B9303) as shown in Fig. 6.8A. If the transmitter malfunctions (locks up, display goes blank, resets etc.) the value of the RC network is too low for suppression and an alternative value must be used. If the correct value cannot be obtained, contact the manufacturer of the switched device for details on the RC unit required.

For **DC applications** fit a diode as shown in Fig. 6.8B. For general applications use an IN5406 type (600V peak inverse voltage at 3A).

Note. For reliable switching the minimum voltage must be greater than 12V and the minimum current greater than 100mA.

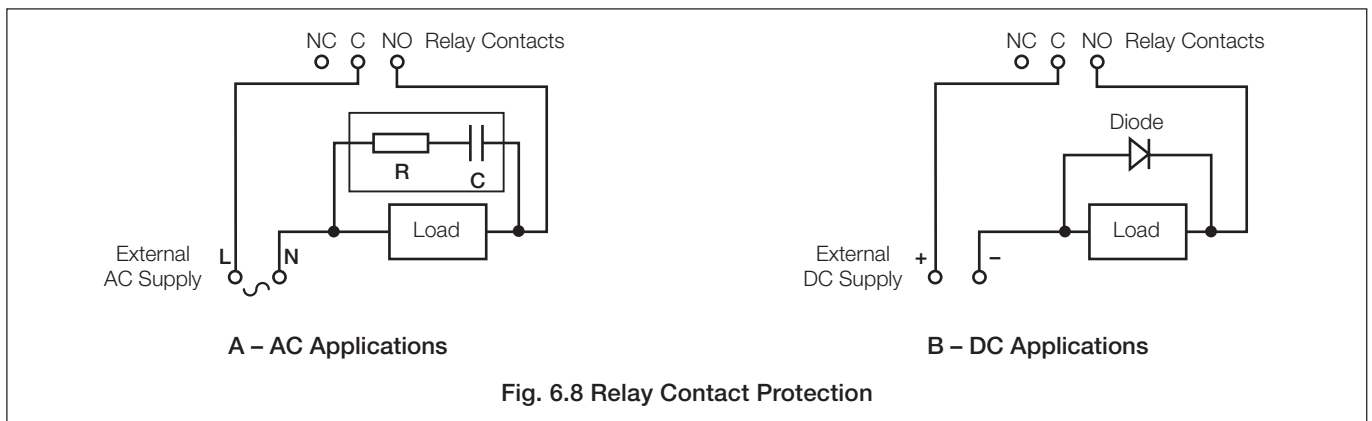

...6.5 Electrical Connections

6.5.2 Cable Entry Knockouts – Fig. 6.9

The monitor is supplied with 7 cable glands, one fitted and six to be fitted, as required, by the user – see Fig. 6.9.

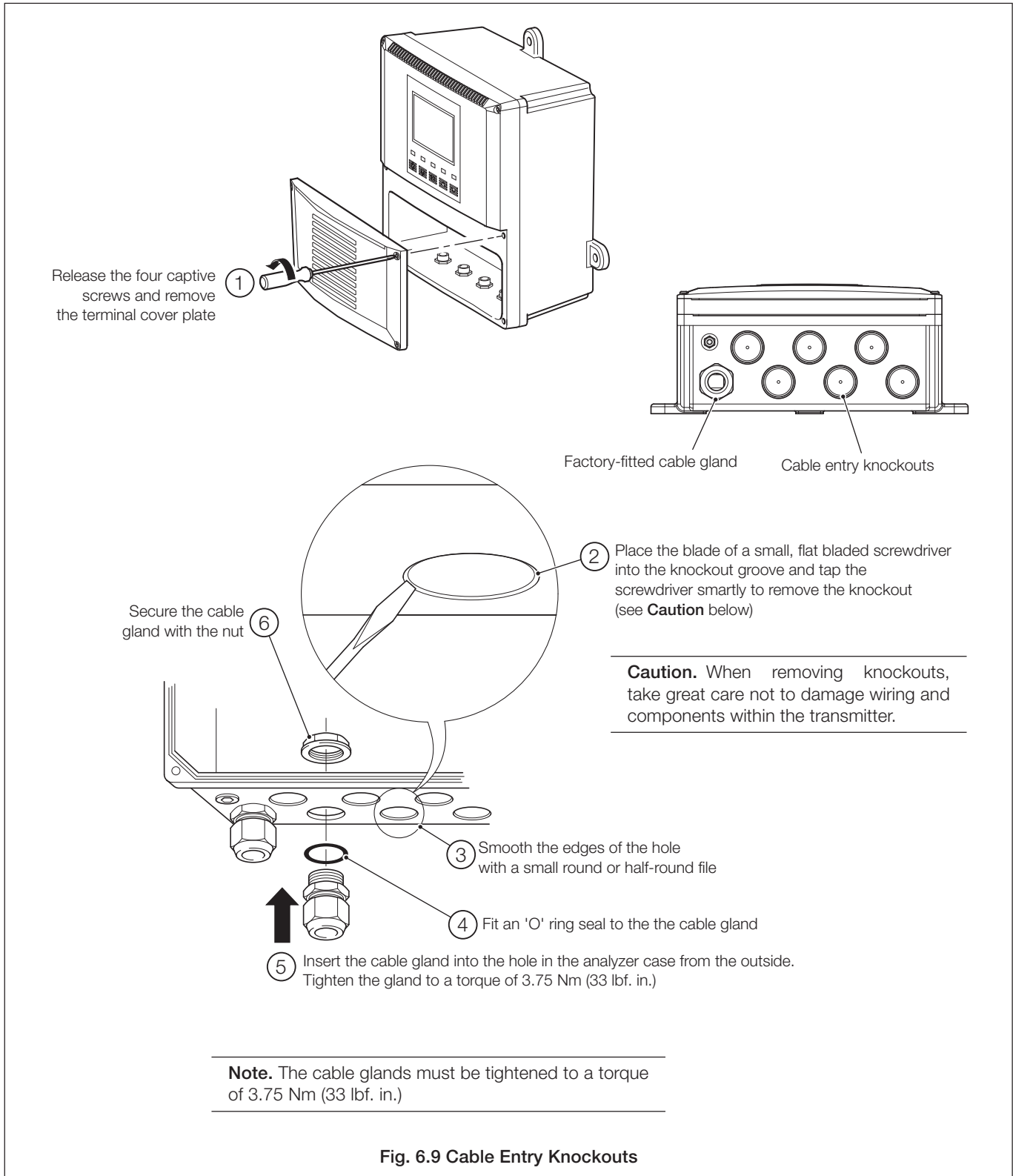

...6.5 Electrical Connections

6.5.3 Access to Terminals – Fig. 6.10

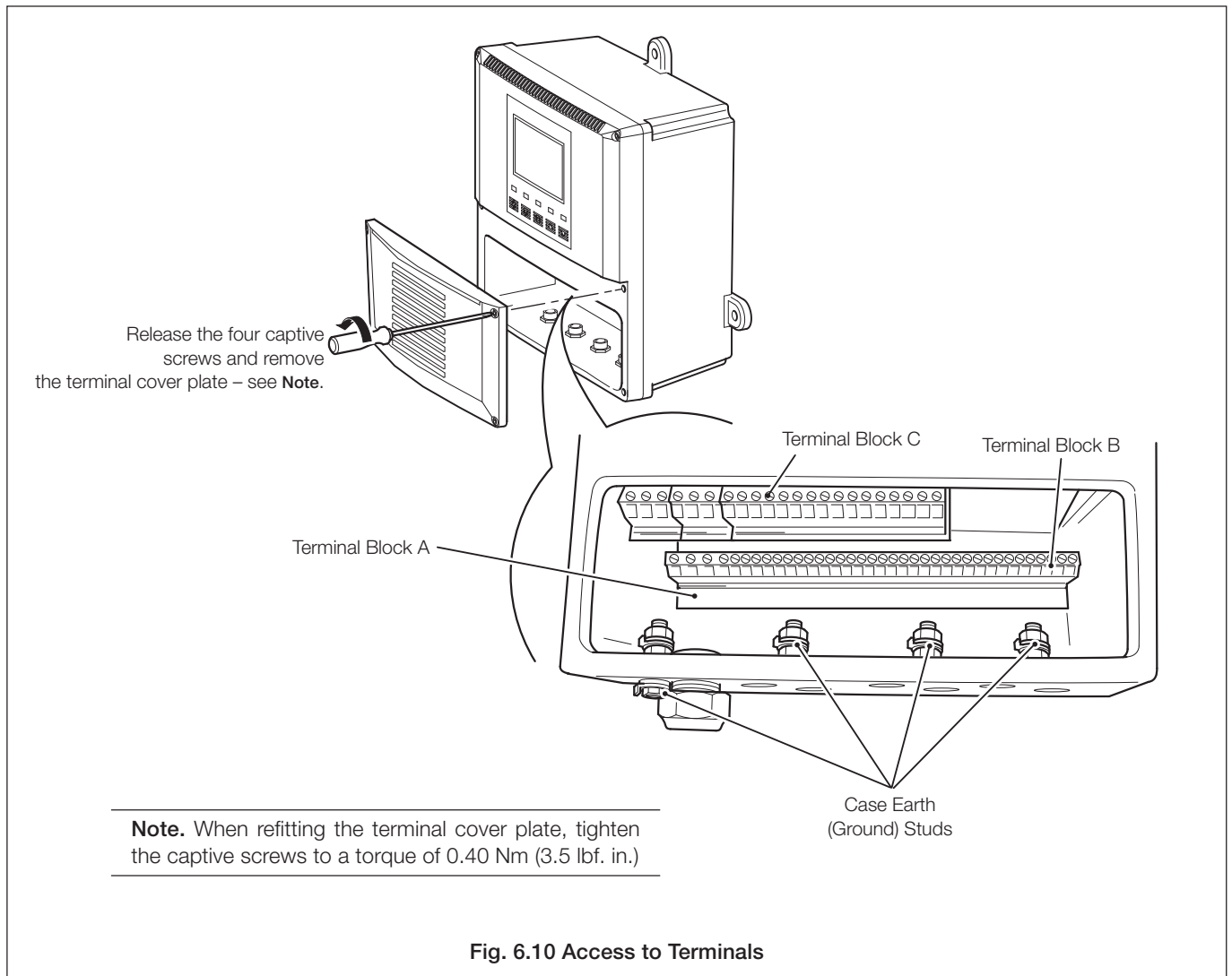

...6 INSTALLATION

...6.5 Electrical Connections

6.5.4 Connections – Fig. 6.11

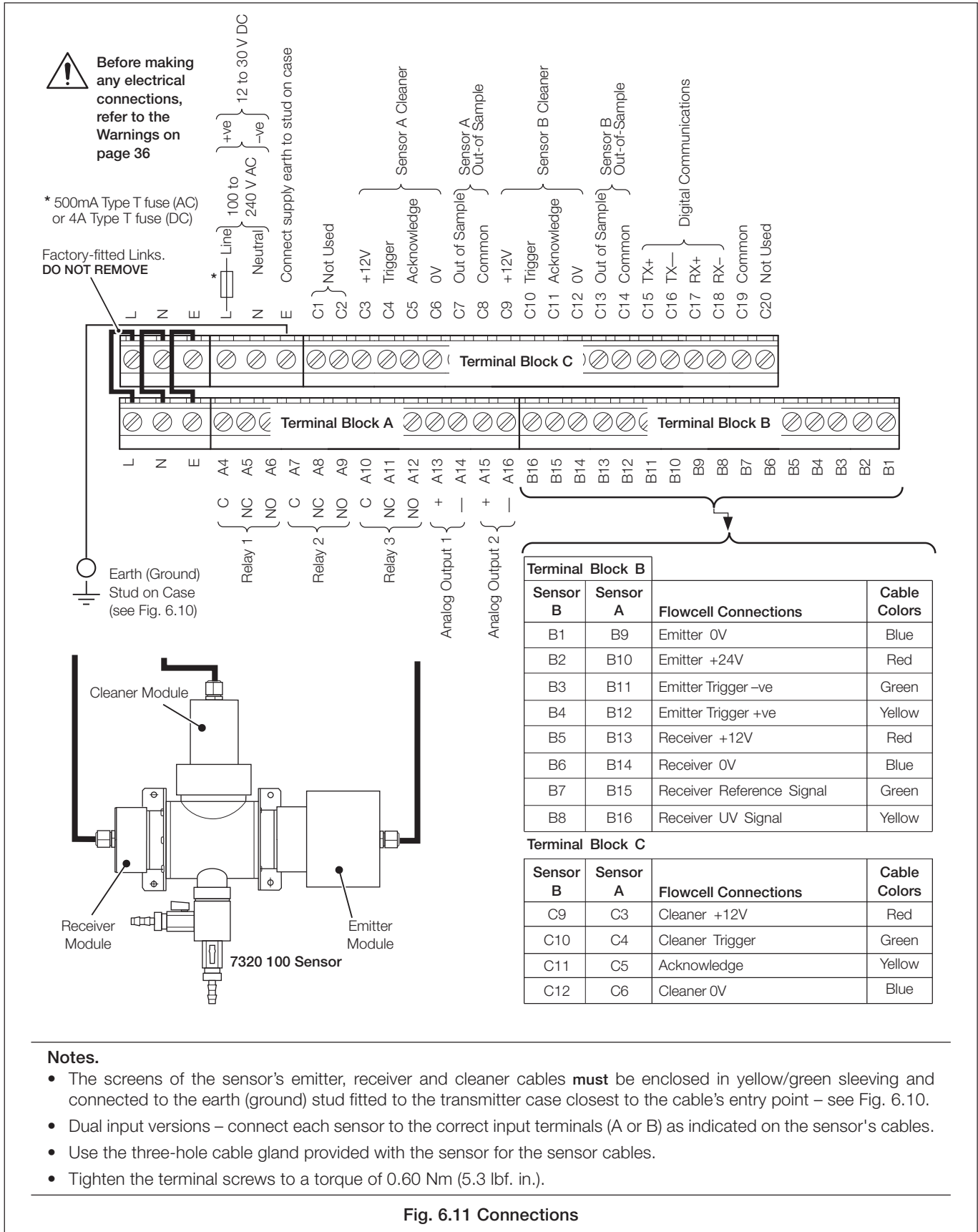

Notes.

- The screens of the sensor's emitter, receiver and cleaner cables **must** be enclosed in yellow/green sleeving and connected to the earth (ground) stud fitted to the transmitter case closest to the cable's entry point – see Fig. 6.10.
- Dual input versions – connect each sensor to the correct input terminals (A or B) as indicated on the sensor's cables.
- Use the three-hole cable gland provided with the sensor for the sensor's cables.
- Tighten the terminal screws to a torque of 0.60 Nm (5.3 lbf. in.).

Fig. 6.11 Connections

7 CALIBRATION

Note. An AV400 System is supplied factory-configured as a matched system with each component bearing the same serial number. If any part of a system is replaced (transmitter or sensor[s]), **a complete factory re-calibration must be carried out.**

7.1 Factory Settings

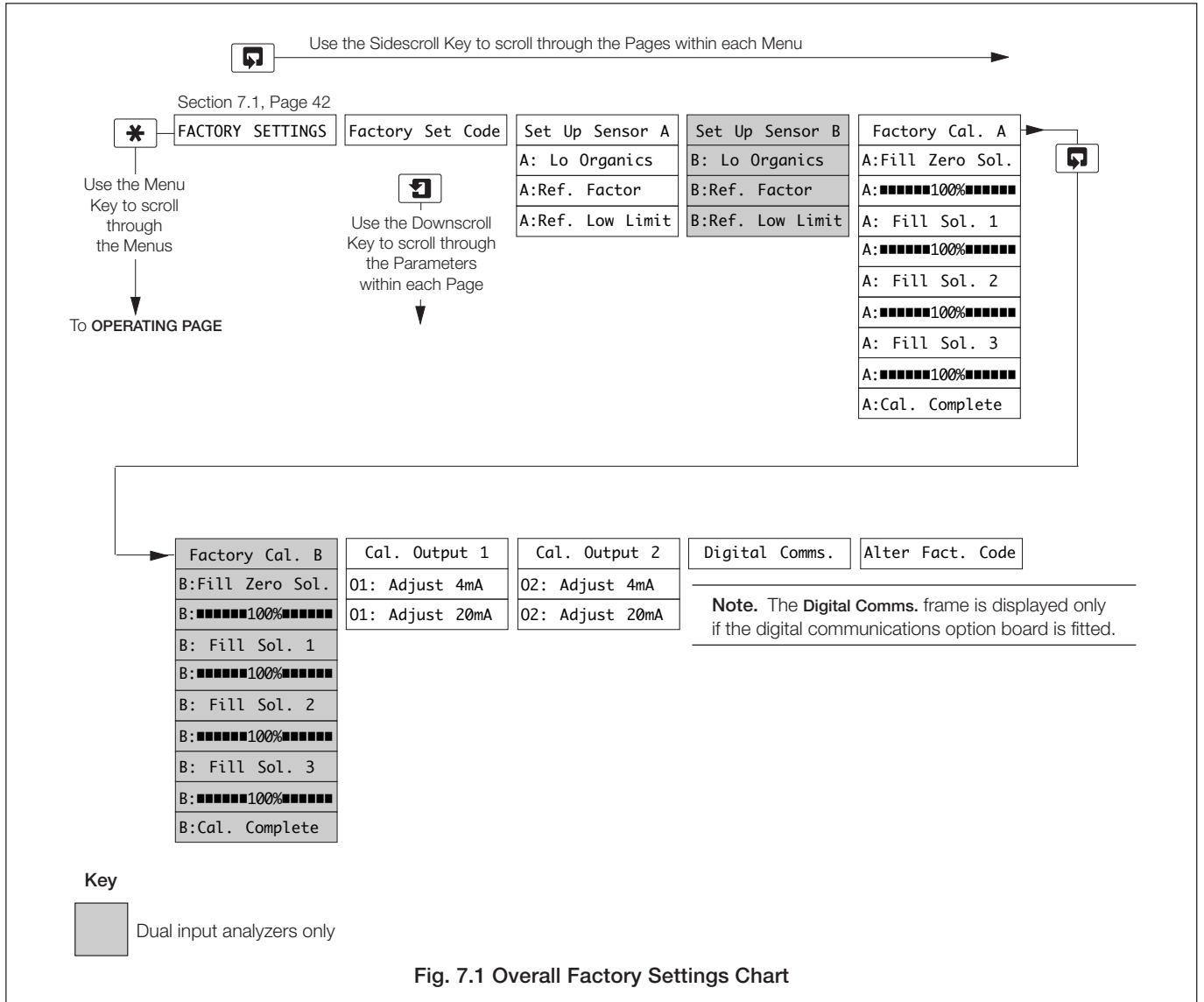
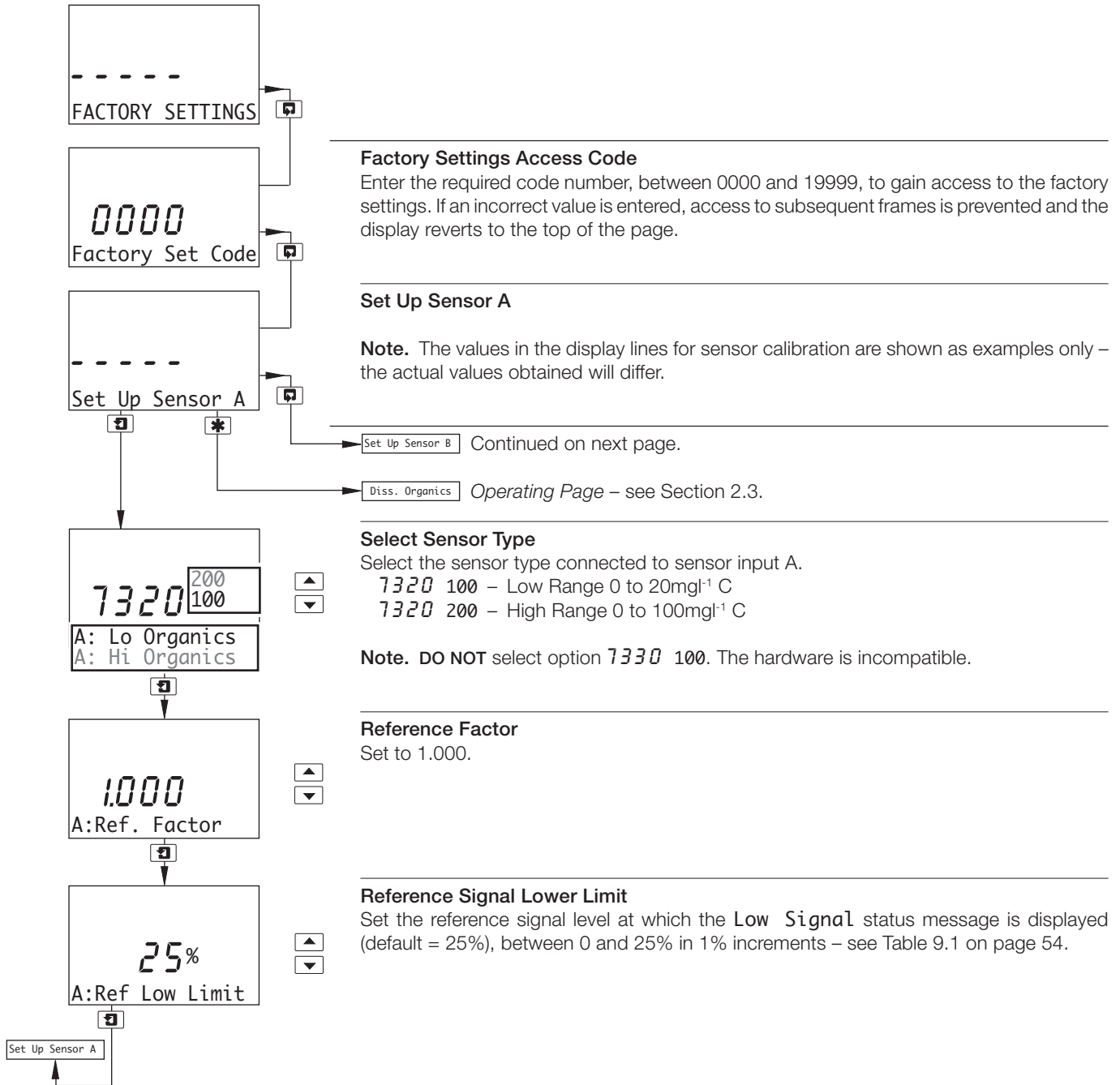
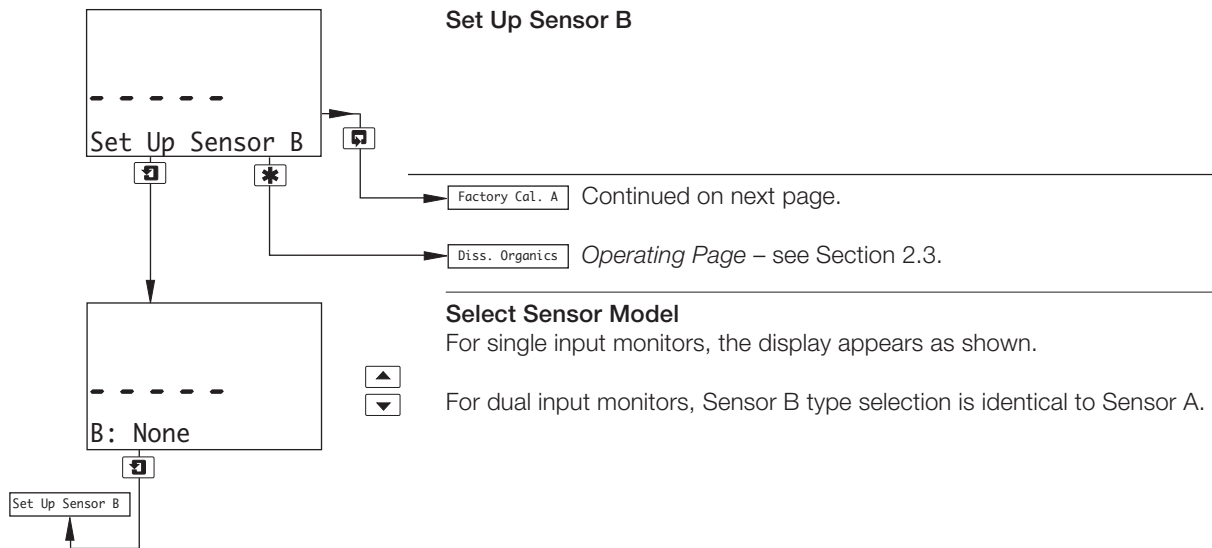

Fig. 7.1 Overall Factory Settings Chart

...7.1 Factory Settings



...7.1 Factory Settings



...7.1 Factory Settings

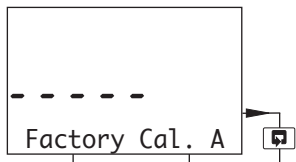

Calibrate Sensor A

Note. The Factory Calibration matches the specific linearity characteristics of the sensor to the transmitter.

Factory Cal. B Sensor B calibration (dual input monitors only) is identical to Sensor A calibration.

Cal. Output 1 Single input monitors only – continued on page 46.

Diss. Organics Operating Page – see Section 2.3.

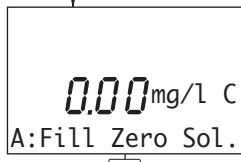

Zero Calibration

Fill the flowcell with de-ionized water.

Press the key to initiate calibration.

Note. If the key is pressed again at any time before calibration is complete, the calibration is aborted and the display advances automatically to the next step.

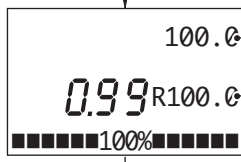

Raw Output from Sensor

Organic signal

Reference signal

As calibration proceeds, a progress indicator appears in the lower display line. After 3 minutes, the lower display line shows , the display then advances automatically to the next step.

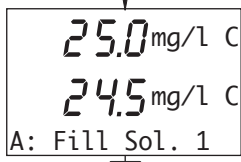

Calibrate with Solution 1

Fill the flowcell with a 5mg/l⁻¹ (7320 100 sensor) or 25mg/l⁻¹ (7320 200 sensor) span standard solution prepared from the stock standard solution – see Section 4.1.2.

Press the key to initiate calibration.

Note. If the key is pressed again at any time before calibration is complete, the calibration is aborted and the display advances automatically to the next step.

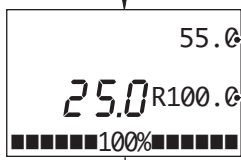

Raw Output from Sensor

Organic signal

Reference signal

As calibration proceeds, a progress indicator appears in the lower display line. After 3 minutes, the lower display line shows , the display then advances automatically to the next step.

A: Fill Sol. 2 Continued on next page.

...7.1 Factory Settings

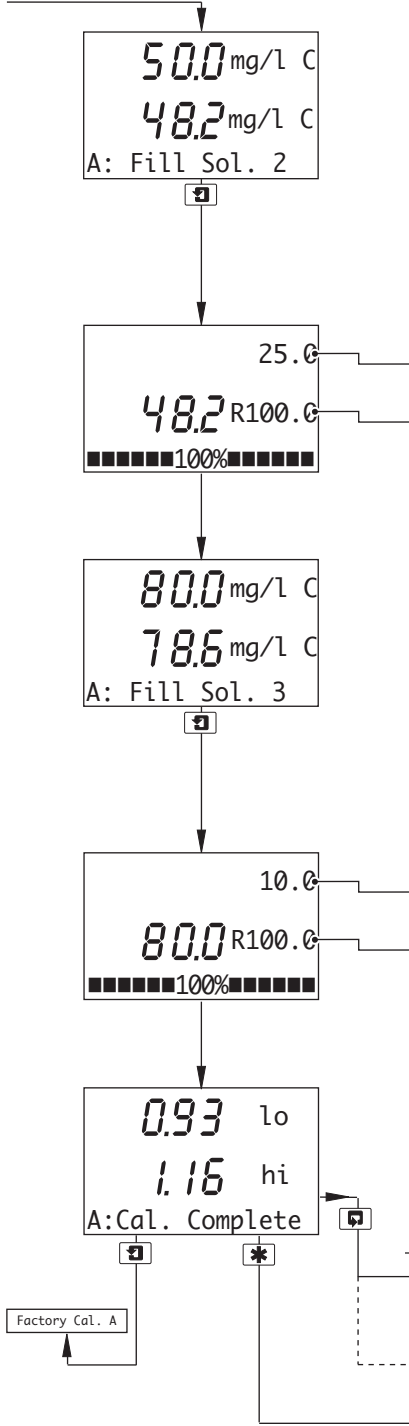

Calibrate with Solution 2

Fill the flowcell with a 10mg^l⁻¹ (7320 100 sensor) or 50mg^l⁻¹ (7320 200 sensor) span standard solution prepared from the stock standard solution – see Section 4.1.2.

Press the key to initiate calibration.

Note. If the key is pressed again at any time before calibration is complete, the calibration is aborted and the display advances automatically to the next step.

Raw Output from Sensor

Organic signal

Reference signal

As calibration proceeds, a progress indicator appears in the lower display line. After 3 minutes, the lower display line shows 100%, the display then advances automatically to the next step.

Calibrate with Solution 3

Fill the flowcell with a 15mg^l⁻¹ (7320 100 sensor) or 80mg^l⁻¹ (7320 200 sensor) span standard solution prepared from the stock standard solution – see Section 4.1.2.

Press the key to initiate calibration.

Note. If the key is pressed again at any time before calibration is complete, the calibration is aborted, the display advances automatically to the next frame and **A:Cal Incomplete** is shown on the lower display line.

Raw Output from Sensor

Organic signal

Reference signal

As calibration proceeds, a progress indicator appears in the lower display line. After 3 minutes, the lower display line shows 100%, the display then advances automatically to the next step.

Calibration Completed

Cal Complete is displayed to indicate a successful calibration.

Note. **Cal Incomplete** is displayed if **any** part of the is calibration is aborted.

Factory Cal. B Sensor B calibration (dual input monitors only) is identical to Sensor A calibration.

Cal. Output 1 Single input monitors only – continued on page 46.

Diss. Organics *Operating Page* – see Section 2.3.

...7.1 Factory Settings

Calibrate Output 1

Note. When adjusting the 4 and 20mA output values, the display reading is unimportant and is used only to indicate that the output is changing when the ▲ and ▼ keys are pressed.

Cal. Output 2 See below.

Adjust 4mA
Set the millimeter reading to 4mA.

Note. The analog output range selected in **Configure Outputs** (see Section 5.5) does not affect the reading.

Refer to Fig. 6.11 for connection details.

Adjust 20mA
Set the millimeter reading to 20mA.

Note. The analog output range selected in **Configure Outputs** (see Section 5.5) does not affect the reading.

Refer to Fig. 6.11 for connection details.

Cal. Output 1

Cal. Output 2 Continued below.

Diss. Organics *Operating Page* – see Section 2.3.

Calibrate Output 2

Note. Output 2 calibration is identical to Output 1 calibration.

Option Board Continued on next page.

Adjust 20mA
Set the millimeter reading to 20mA.

Note. The analog output range selected in **Configure Outputs** (see Section 5.5) does not affect the reading.

Option Board Continued on next page.

Diss. Organics *Operating Page* – see Section 2.3.

...7.1 Factory Settings

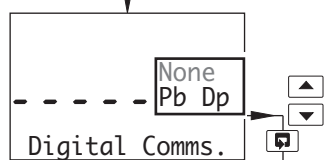
**Configure Digital Communications Option Board**

Select the communications mode required:

- Pb Dp – PROFIBUS-DP digital communications enabled
- None – Digital communications disabled

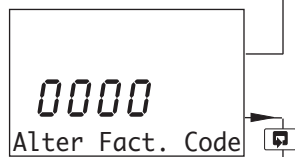
**Alter Factory Code**

Set the factory settings access code to a value between 0000 and 19999.

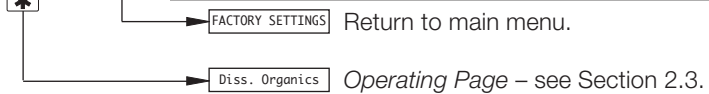

8 SENSOR MAINTENANCE

8.1 Scheduled Maintenance



Warning. DO NOT open the emitter module. It uses high voltages that can cause serious injury or death.

Note. The emitter and receiver modules contain no user-serviceable parts and are sealed in clean and dry conditions at the factory. Opening them will lead to degraded performance. See also the **Warning** above.

The following maintenance schedule is a general guide only. The systems are designed for a wide range of applications where the nature of the sample can vary considerably, therefore it is necessary to amend the schedule to suit the particular installation and sample conditions.

8.2 Cleaning the Sensor

Routine maintenance is limited to cleaning out the flowcell manually to remove accumulated fouling or sediment. The flowcell **must** be cleaned prior to calibration (see Section 4) to ensure that the Zero and Span standards are not contaminated by organic matter that may be present inside.

8.2.1 Dismantling and Cleaning – Figs. 8.1 to 8.4



Warning. Isolate the transmitter and sensor from the power supply before dismantling the sensor.



Warning. The sensor emitter module contains a high intensity xenon strobe lamp that emits ultraviolet (UV) radiation. ***This must NOT be viewed with the naked eye and must NEVER be operated while outside the sensor.*** Under normal operating conditions, it is not possible to see the light source but, if the sensor is dismantled with electrical power applied, it may be possible to expose the eyes to the strobe flash.

Notes.

- The emitter and receiver modules contain precision optical components and must be handled accordingly.
 - The emitter module contains the power supply, voltage control and lamp components. As a result, it is heavy and requires extra support.
 - Do not support the modules by the cable(s) entering their enclosures.
 - Ensure that the O-rings are removed with the screw collars securing the cleaner, emitter and receiver modules; it is possible for these seals to be left inside the flowcell.
-

...8.2.1 Dismantling and Cleaning – Figs. 8.1 to 8.4

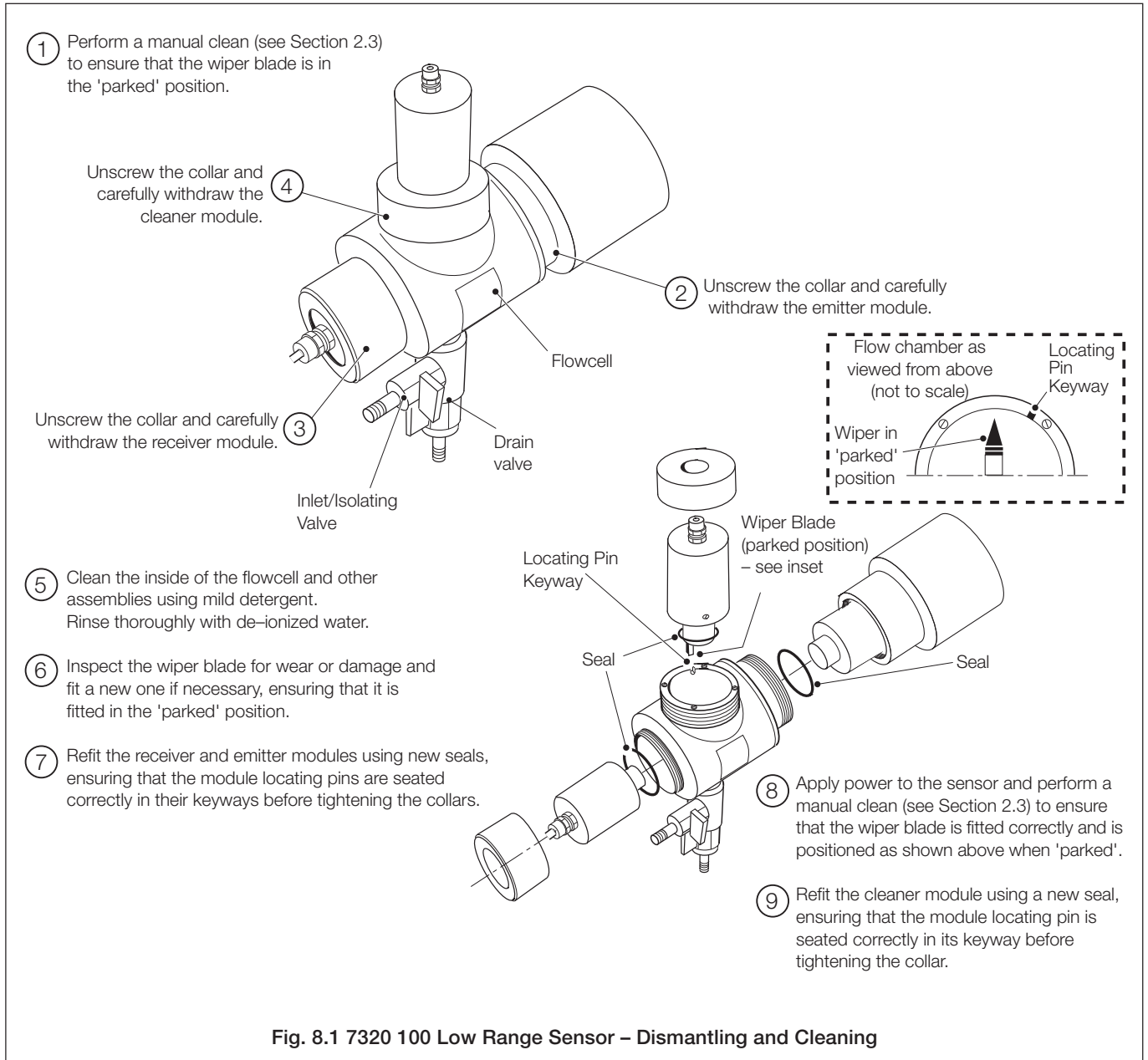
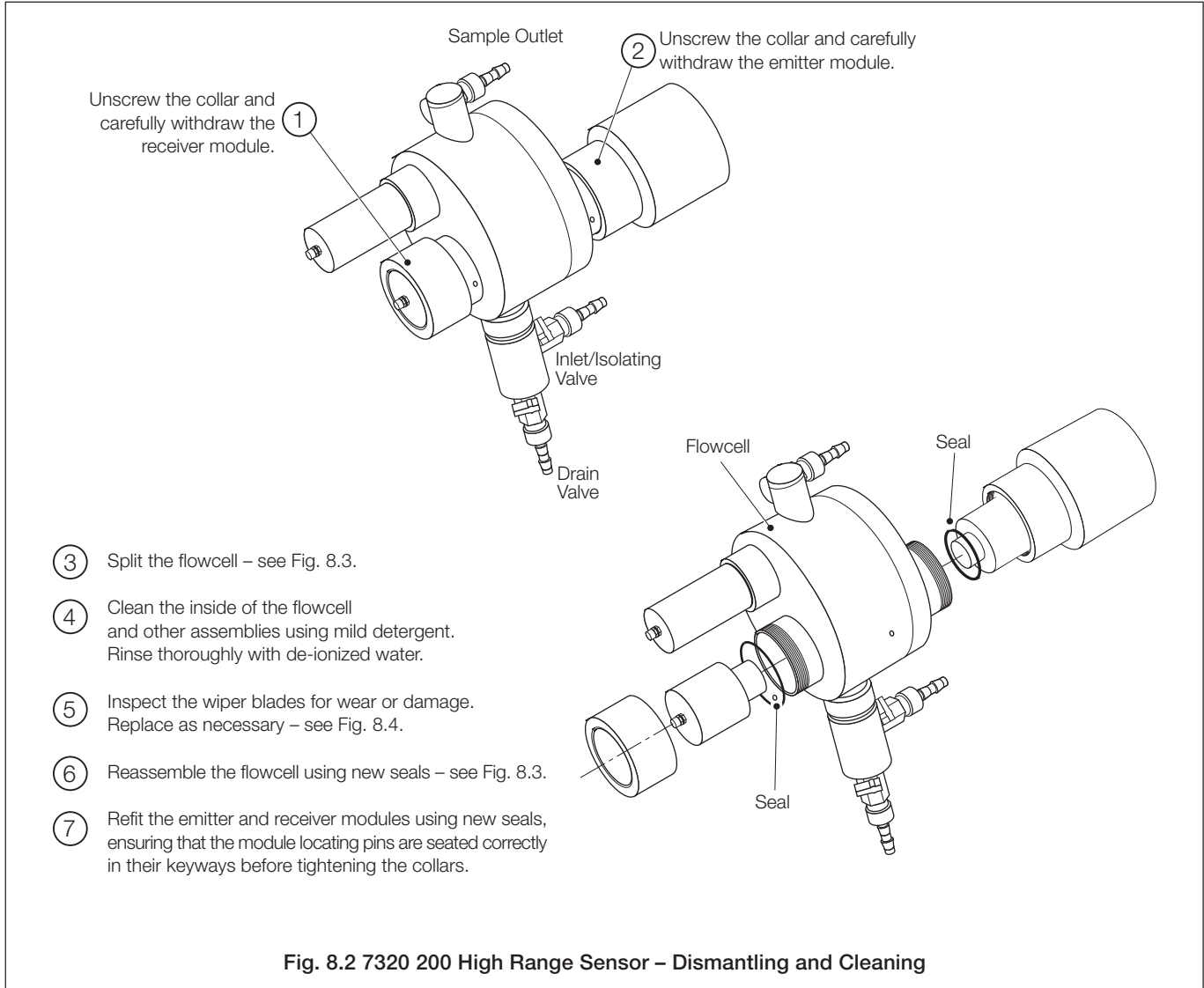
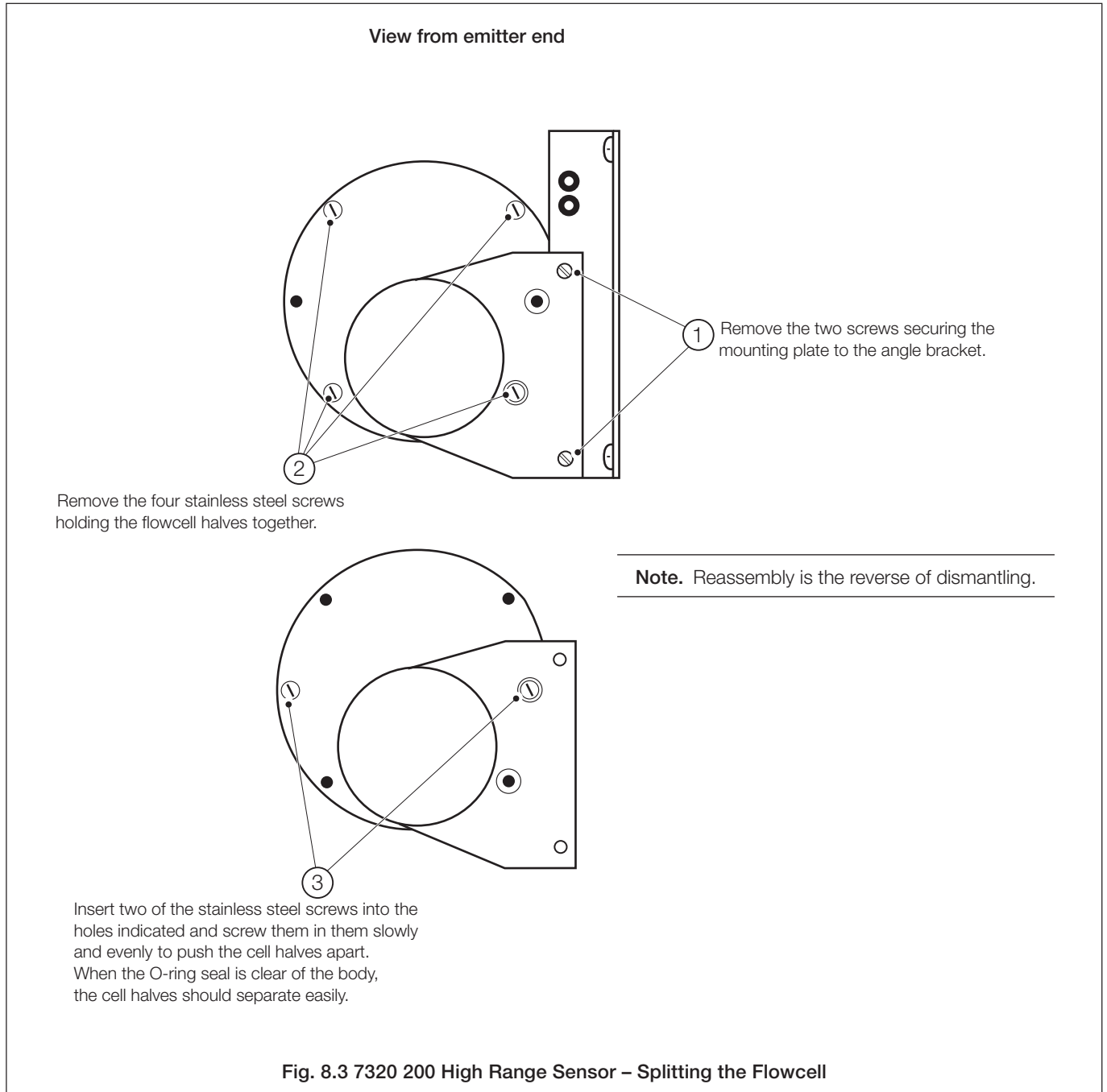

Fig. 8.1 7320 100 Low Range Sensor – Dismantling and Cleaning

...8.2.1 Dismantling and Cleaning – Figs. 8.1 to 8.4



...8.2.1 Dismantling and Cleaning – Figs. 8.1 to 8.4



...8.2.1 Dismantling and Cleaning – Figs. 8.1 to 8.4

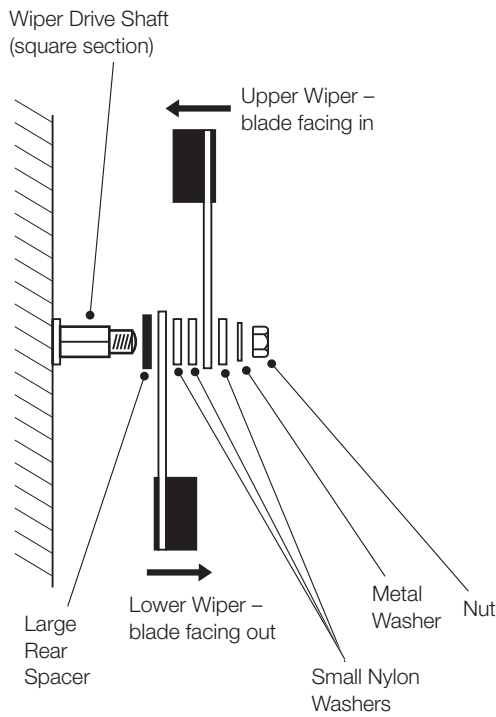

Notes.

- The proper functioning of the cleaner system depends on the correct assembly of the washers and orientation of the wiper blades.
- Do not use the wiper blade arms to rotate the wiper drive shaft.

- ① Remove the wiper blade securing nut.
- ② Remove the blades and washers from the drive shaft.
- ③ Ensure the blade drive shaft is correctly positioned by performing a manual clean (see Section 2.3) to 'park' the blades.
- ④ Reassemble the components on the drive shaft in the order shown, ensuring the wiper blades are in the parked position, i.e. horizontal.
- ⑤ Using suitable spanners, prevent the wiper drive shaft from turning and tighten the wiper blade securing nut.
- ⑥ Perform a manual clean (see Section 2.3) to check system operation. Ensure blades 'park' correctly.

Wiper Blades in the Parked Position

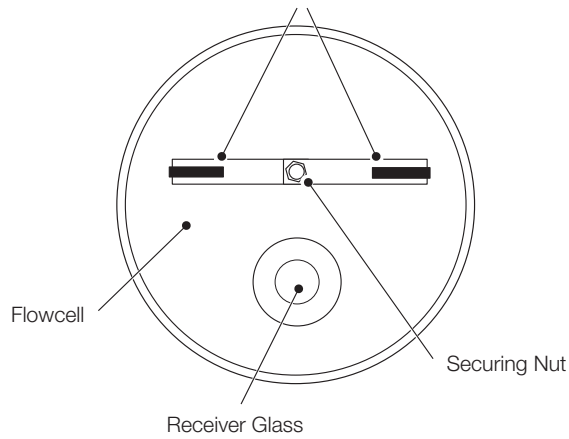

Fig. 8.4 7320 200 High Range Sensor – Replacing the Wiper Blades

8.3 Replacing the Emitter and Receiver Modules

Notes.

- The emitter and receiver modules are matched during manufacture. If either module fails, return both to the Company for repair/replacement.
 - Refer to the Warnings and Notes in Sections 8.1 and 8.2.1 before removing the modules from the flowcell.
 - Under **NO** circumstances dismantle the modules.
-

- 1) Isolate the system from the power supply.
- 2) Disconnect the cables from the emitter and receiver modules.
- 3) Refer to Fig. 8.1 (7320 100 Low Ranger Sensor) or Fig. 8.2 (7320 200 High Range Sensor) and remove the emitter and receiver modules.
- 4) Refer to Fig. 8.1 (7320 100 Low Ranger Sensor) or Fig. 8.2 (7320 200 High Range Sensor) and fit the new modules.
- 5) Refer to Fig. 6.11 and reconnect the emitter and receiver cables.
- 6) Restore the power supply to the system and allow to warm up for five minutes.
- 7) Adjust the emitter brightness – see Section 8.4.

8.4. Adjusting the Emitter Brightness

- 1) Fill the flowcell with high purity water.
- 2) Select the **TEST/MAINTENANCE** Page (see Section 5.9).
- 3) Scroll to the **Org. Totals** frame (page 28) for the relevant sensor.
- 4) Remove the small plug on the left hand side of the emitter module.
- 5) Using a long, small-bladed screwdriver, adjust the multi-turn potentiometer until **Span A** (or **Span B**) value reads **100 ±10**.

Note. If this value cannot be obtained, contact the Company.

- 6) Check that the **Span A** values in the **Org. Peak** and **Ref. Peak** frames are between 200 and 250.

Note. If these values are outside the limits, contact the Company.

- 7) Refit the plug removed at step 4.
- 8) Calibrate the sensor – see Section 4.2.
- 9) Return the system to normal operation.

9 DIAGNOSTICS

9.1 Status Messages

The diagnostic facilities incorporated in the software displays the appropriate system status message (see Table 9.1) in the *Operating Page* (see Section 2.3) if a fault is detected.

Status Message	Cause	Action
A: Lamp Disabled B: Lamp Disabled	The sensor lamp has been disabled manually in the <i>Operating Page</i> .	See Section 2.3.
A: Out of Sample B: Out of Sample	Loss of sample/flow pressure detected by the external sample switch contact.	Restore sample/flow pressure.
A: Low Signal B: Low Signal	No signal received from the sensor. Possible causes are:	
	a) Sensor requires cleaning.	Clean sensor – see Section 8.2.
	b) Failure of the cleaner module.	Dismantle sensor to reveal wiper blades (see Section 8.2) and check operation of cleaner module by performing a manual clean – see Section 2.3.
	c) Faulty connections between monitor/sensor.	Check monitor/sensor connections – see Section 6.5.
	d) Failure of lamp power supply.	Return the emitter and receiver modules to the Company for repair.
e) Failure of the emitter and/or receiver module.	Return the emitter and receiver modules to the Company for repair.	
A: Cleaner Fail B: Cleaner Fail	Failed or jammed cleaner module.	Contact the Company.
Input Brd. Fault 24 V Power Loss 12 V Power Loss Check FlexiCable RAM Fault	Monitor hardware fault.	Contact the Company.

Table 9.1 Status Messages

9.2 Unstable or Erratic Readings

This is usually caused by air bubbles in the sample and is more pronounced on the low level sensor due to its greater sensitivity. These bubbles are usually as a result of degassing of the sample caused by either a drop in sample pressure or a rise in sample temperature. Cleaning the optical windows and increasing the flow through the flowcell usually overcomes the problem but if it is severe, install a de-bubbler unit – see Section 6.4.

If erroneous or unexpected results are obtained the fault may be indicated by an error message – see Table 9.1. However, some faults may cause problems with monitor calibration or give discrepancies when compared with independent laboratory measurements.

10 SPARES

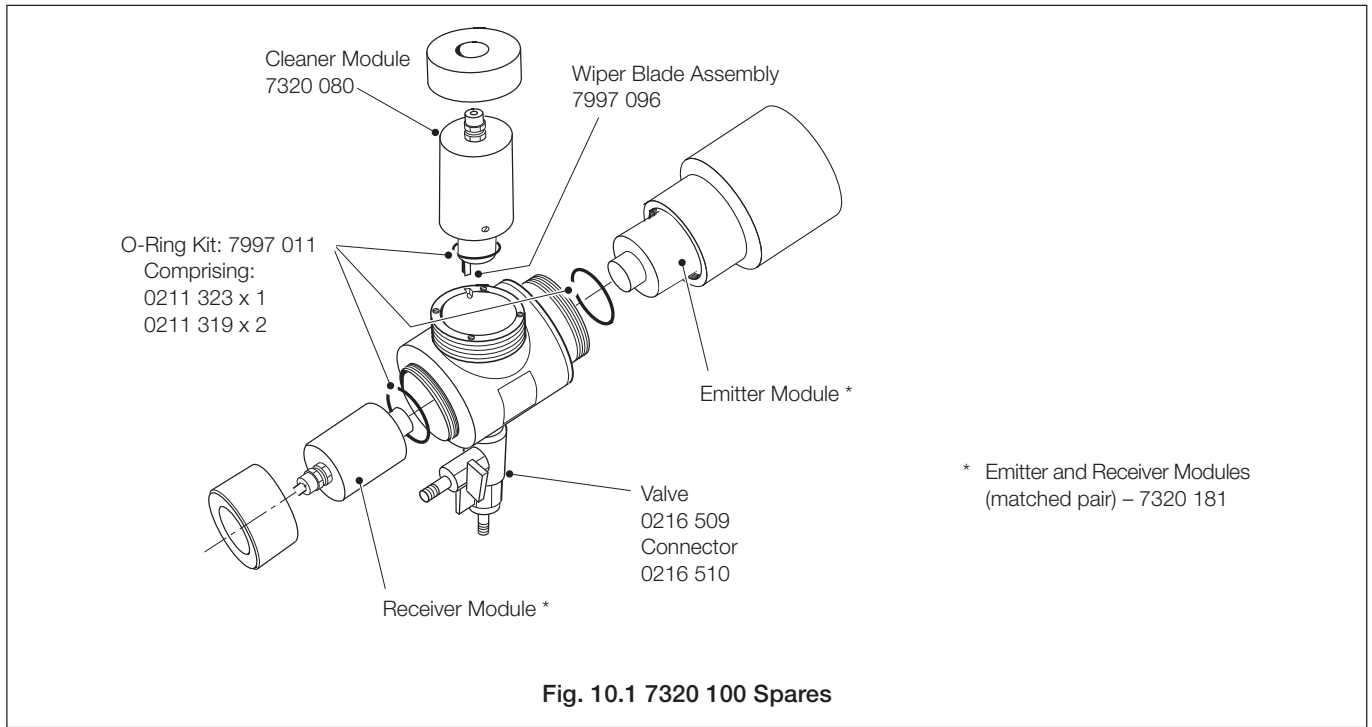

Fig. 10.1 7320 100 Spares

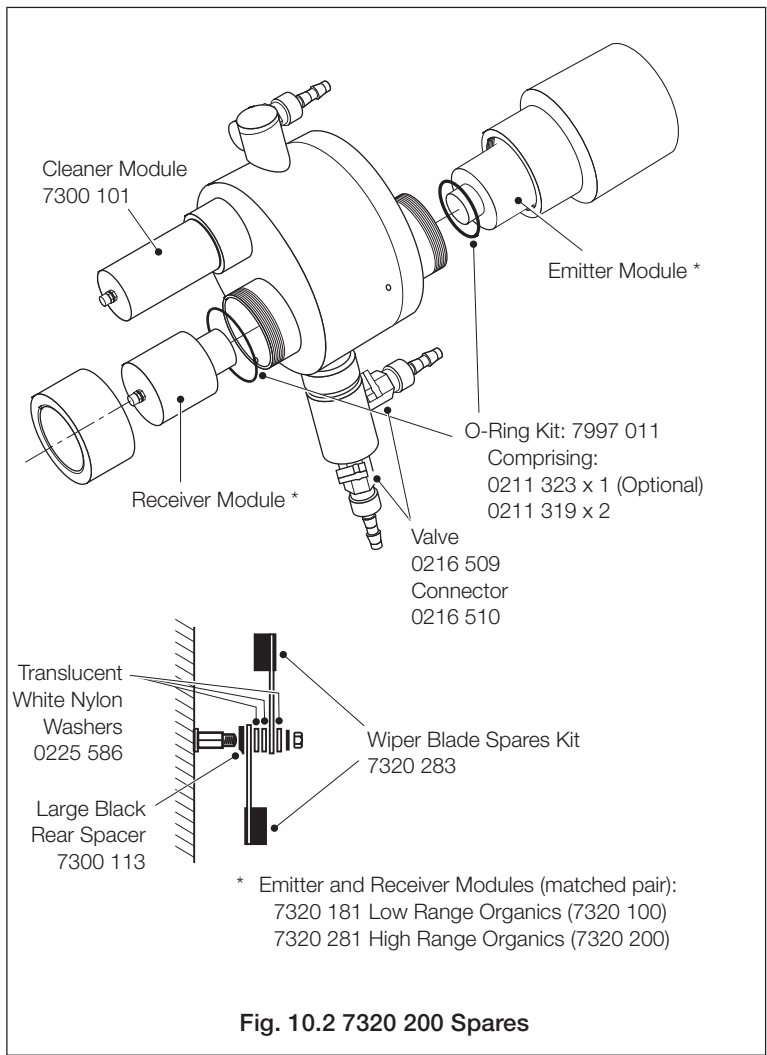

Fig. 10.2 7320 200 Spares

Description	Part Number
AV400 Monitor	Contact the Company
Processor and Main PSU/P Board (85 to 260V AC)	AX400/0249
Processor and Main PSU/P Board (12 to 30V DC)	AX400/0259
AV400 EPROM	AX400/2000
Display Module	AX400/0295
Multifunction Board (85 to 260V AC)	AX400/0425
Multifunction Board (12 to 30V DC)	AX400/0426
UV Scanning Input Board	AX400/0415
Seal – Terminal Cover	AX400/0119
Seal – Main Case	AX400/0118
Pipe Mounting Kit	AX400/0090

Table 10.1 AV400 Monitor Spares

SPECIFICATION

Specification

General

Sensor range

(Based on potassium hydrogen phthalate calibration standards)

AV410/411	Low range 0 to 20mg ^l -1 C
AV420/422	High range 0 to 100mg ^l -1 C

Linearity

Low range	±2% of reading or 0.15mg ^l -1 C whichever is the greater
High range	±2% of reading or 0.5mg ^l -1 C whichever is the greater

Reproducibility

Low range	±0.15mg ^l -1 C
High range	±0.5mg ^l -1 C

Inferred units

Absorbance units/metre
Color (°H)
Coagulant dose (mg^l-1)
TOC (mg^l-1)
User Defined

Maximum current output scale expansion

Low range	0 to 2mg ^l -1 C
High range	0 to 20mg ^l -1 C

Response time

Normally three minutes for 90% step change depending on damping factor

Lamp life

Rated by the manufacturer at 1.2 x 10⁹ flashes (10 years continuous operation at the rate of one flash at 2s intervals [typical] equates to 13.1% of the rated lamp life)

Internal wiper cleaning system

Programmable, operation frequency 15, 30, 45 and 60 minutes 2, 4, 6, 12 and 24 hours

Maximum distance between transmitter and sensor

750mm (29.5 in.)

Sample

Flow rate

0.5 to 5l min⁻¹ (free of air bubbles).
A higher flow rate is required at high turbidity levels

Temperature

0 to 40°C (32 to 104°F)

Pressure

The sensor should be operated at atmospheric pressure but can withstand 3bar (43.4 psi) max.

Display

Type

Dual 4¹/₂-digit, 7-segment backlit LCD

Information

16-character, single line dot matrix

Resolution

Low range	0.01mg ^l -1
High range	0.1mg ^l -1

Energy saving function

Backlit LCD configurable as ON or Auto Off after 60 seconds

Logbook

Electronic record of major events and calibration data

Real-time clock

Records time for logbook and auto cleaning

Diagnostics

Out of sample
Lamp disabled
Loss of signal
Electronic failure

Languages

English
French
German
Italian
Spanish

Outputs

Current Outputs

Number of signals

2 fully isolated current outputs supplied as standard, configurable to one or both sensor outputs

Current outputs also programmable to any value between 0 and 22mA to indicate system failure

Output current

0 to 10mA, 0 to 20mA or 4 to 20mA

Maximum load resistance

750Ω at 20mA

Accuracy

±0.25% FSD ±5% of reading

Resolution

0.1% at 10mA, 0.05 at 20mA

Serial communication

PROFIBUS

Relay outputs**Number of relays**

Three supplied as standard,
configurable to one or both sensor inputs or status

Set point adjustment

Fully programmable as normal or failsafe, high/low or status

Hysteresis

Programmable 0 to 5% in 0.1% increments

Delay

Programmable 0 to 100 minutes in 1 minute intervals

Relay contacts

Single-pole changeover
Rating 5A 115/230V AC, 5A DC

Insulation

2kV RMS contacts to earth/ground

Power supply**Voltage requirements**

100 to 240 V AC, 50/60 Hz
(90 V Min. to 264 V Max. AC)
Optional 12 to 30 V DC

Power consumption

20 W

Insulation

Mains to earth (line to ground) 2kV RMS

Mechanical Data**Transmitter**

IP65 (not evaluated under UL certification)
Dimensions 192mm (7.56 in.) high x 230mm (9.06 in.) wide x
94mm (3.7 in.) deep
Weight 1kg (2.2 lb)

Sensor

Low Range Dimensions 327mm (12.87 in.) wide
x 410mm (16.14 in.) high x 162mm (6.38 in.) deep
High Range Dimensions 405mm (15.94 in.) wide
x 373mm (14.68 in.) high x 136mm (5.35 in.) deep
Weight 6kg (13.2 lb)

Cable entry types

Standard 5 or 7 x M20 cable glands
N. American 7 x knockouts suitable for 1/2 in. Hubble gland

Environmental Data**Operating temperature limits**

0 to 50°C (32 to 122°F)

Storage temperature limits

-25 to 75°C (-13 to 167°F)

Operating humidity limits

Up to 95%RH non-condensing

EMC emissions and immunity

Meets requirements of:
EN61326 (for an industrial environment)
EN50081-2
EN50082-2

Approvals, Certification and Safety**Safety approval**

UL

CE Mark

Covers EMC & LV Directives (including latest version EN 61010)

General safety

EN61010-1
Overvoltage Class II on inputs and outputs
Pollution Category 2

APPENDIX A REPLACING A 7320 TRANSMITTER WITH AN AV400

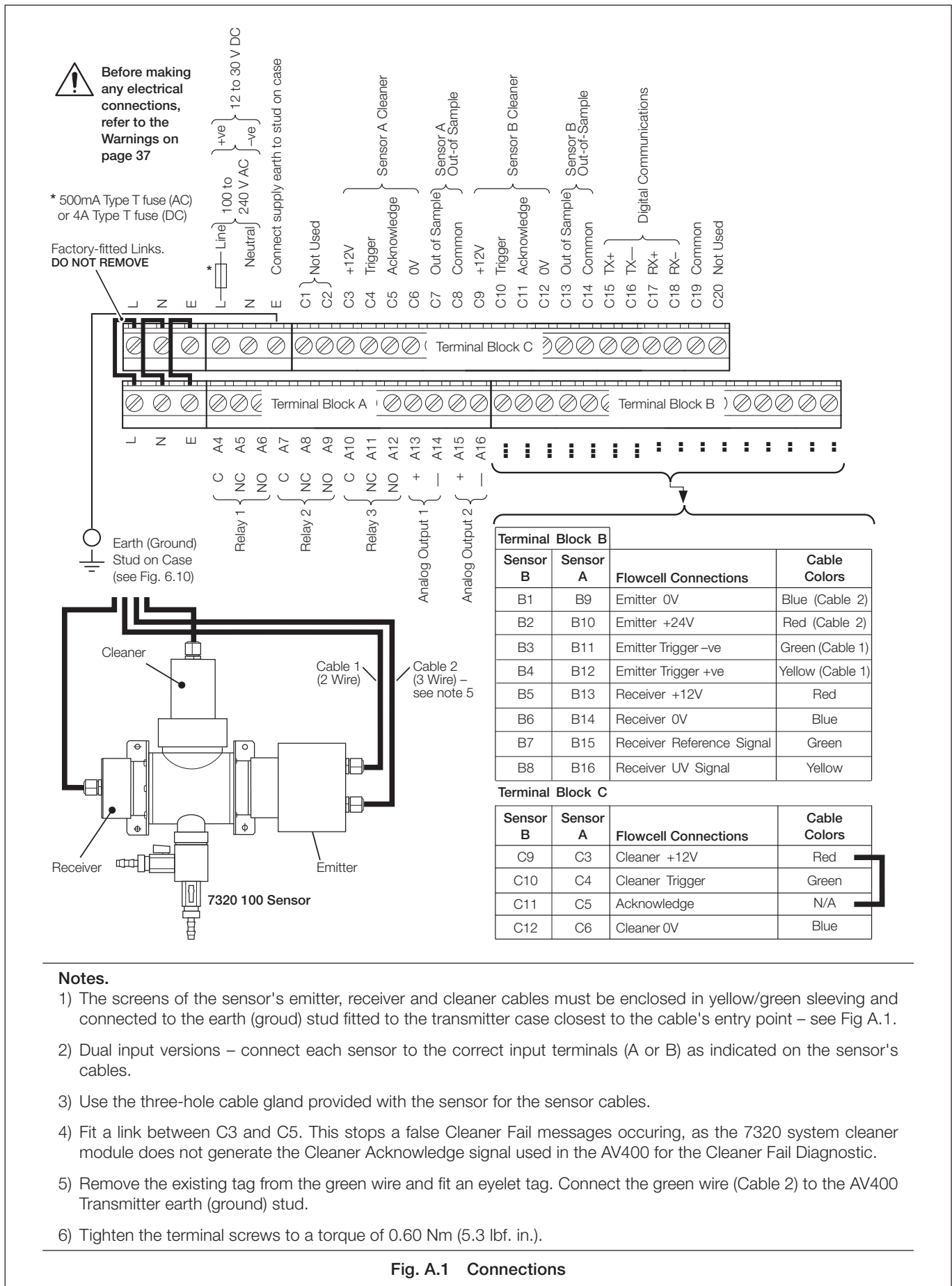

Notes.

- 1) The screens of the sensor's emitter, receiver and cleaner cables must be enclosed in yellow/green sleeving and connected to the earth (ground) stud fitted to the transmitter case closest to the cable's entry point – see Fig A.1.
- 2) Dual input versions – connect each sensor to the correct input terminals (A or B) as indicated on the sensor's cables.
- 3) Use the three-hole cable gland provided with the sensor for the sensor cables.
- 4) Fit a link between C3 and C5. This stops a false Cleaner Fail messages occurring, as the 7320 system cleaner module does not generate the Cleaner Acknowledge signal used in the AV400 for the Cleaner Fail Diagnostic.
- 5) Remove the existing tag from the green wire and fit an eyelet tag. Connect the green wire (Cable 2) to the AV400 Transmitter earth (ground) stud.
- 6) Tighten the terminal screws to a torque of 0.60 Nm (5.3 lbf. in.).

Fig. A.1 Connections

Products and customer support

Automation Systems

For the following industries:

- Chemical & Pharmaceutical
- Food & Beverage
- Manufacturing
- Metals and Minerals
- Oil, Gas & Petrochemical
- Pulp and Paper

Drives and Motors

- AC and DC Drives, AC and DC Machines, AC Motors to 1kV
- Drive Systems
- Force Measurement
- Servo Drives

Controllers & Recorders

- Single and Multi-loop Controllers
- Circular Chart and Strip Chart Recorders
- Paperless Recorders
- Process Indicators

Flexible Automation

- Industrial Robots and Robot Systems

Flow Measurement

- Electromagnetic Flowmeters
- Mass Flowmeters
- Turbine Flowmeters
- Wedge Flow Elements

Marine Systems & Turbochargers

- Electrical Systems
- Marine Equipment
- Offshore Retrofit and Refurbishment

Process Analytics

- Process Gas Analysis
- Systems Integration

Transmitters

- Pressure
- Temperature
- Level
- Interface Modules

Valves, Actuators and Positioners

- Control Valves
- Actuators
- Positioners

Water, Gas & Industrial Analytics Instrumentation

- pH, Conductivity and Dissolved Oxygen Transmitters and Sensors
- Ammonia, Nitrate, Phosphate, Silica, Sodium, Chloride, Fluoride, Dissolved Oxygen and Hydrazine Analyzers
- Zirconia Oxygen Analyzers, Katharometers, Hydrogen Purity and Purge-gas Monitors, Thermal Conductivity

Customer support

We provide a comprehensive after sales service via a Worldwide Service Organization. Contact one of the following offices for details on your nearest Service and Repair Centre.

UK

ABB Limited
Tel: +44 (0)1453 826661
Fax: +44 (0)1453 829671

USA

ABB Inc.
Tel: +1 215 674 6000
Fax: +1 215 674 7183

Client Warranty

Prior to installation, the equipment referred to in this manual must be stored in a clean, dry environment, in accordance with the Company's published specification. Periodic checks must be made on the equipment's condition. In the event of a failure under warranty, the following documentation must be provided as substantiation:

- A listing evidencing process operation and alarm logs at time of failure.
- Copies of all storage, installation, operating and maintenance records relating to the alleged faulty unit.

Contact us

ABB Limited

Process Automation

Oldends Lane
Stonehouse
Gloucestershire GL10 3TA
UK

Tel: +44 1453 826 661

Fax: +44 1453 829 671

ABB Inc.

Process Automation

125 E. County Line Road
Warminster
PA 18974
USA

Tel: +1 215 674 6000

Fax: +1 215 674 7183

www.abb.com

Note

We reserve the right to make technical changes or modify the contents of this document without prior notice. With regard to purchase orders, the agreed particulars shall prevail. ABB does not accept any responsibility whatsoever for potential errors or possible lack of information in this document.

We reserve all rights in this document and in the subject matter and illustrations contained therein. Any reproduction, disclosure to third parties or utilization of its contents in whole or in parts – is forbidden without prior written consent of ABB.

Copyright© 2011 ABB

All rights reserved