

C1900 Series Circular Chart Recorder / Controller

C1900 – dependable recording and full PID control united in a rugged, functional instrument

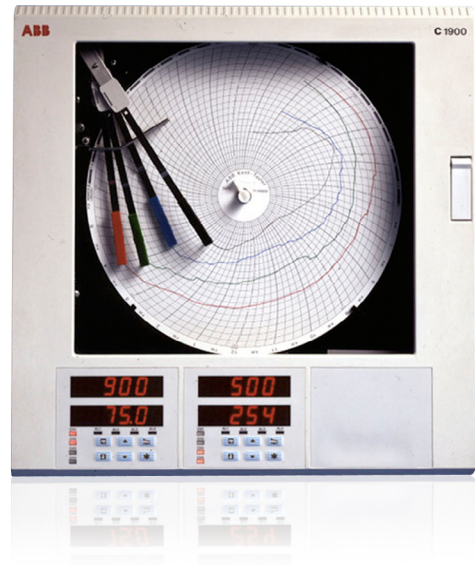

1 to 4 pen recording

- full application flexibility

1 or 2 controllers

- integrated control and recording

Analog, relay outputs, digital inputs and transmitter power supply as standard

- range of inputs and outputs built-in

PID autotune on demand

- optimum loop control

20 programmable ramp/soak profiles

- multiple recipe capability

NEMA 4X/IP66 construction

- hose-down protection

0.1 % measurement accuracy

- precise process information

RS485 MODBUS serial communications

- open system compatibility

C1900

The C1900 is a fully programmable circular chart recorder/controller combining two PID control loops with 4-pen recording. The C1900's straightforward operator controls and robust construction make it suitable for a variety of industrial environments. Excellent standard facilities are complemented by a powerful range of options to give the flexibility to match your application.

Comprehensive Process Information

The C1900 lets you see the status of your process at a glance: **high visibility 6-digit LED displays** provide a clear indication of all process signals. Dedicated operator stations for each controller give continuous displays of set points, measured values and high-visibility deviation bargraphs. Active alarms are signalled by flashing LEDs below the main displays.



4-pen Recording

The chart is easily set up to show the information you need in the way you want. Pen ranges are individually set to give the best resolution for each signal; additionally, a **true-time event pen** facility enables one pen to be set up as a 3-position event marker on the same time line as Pen 1.

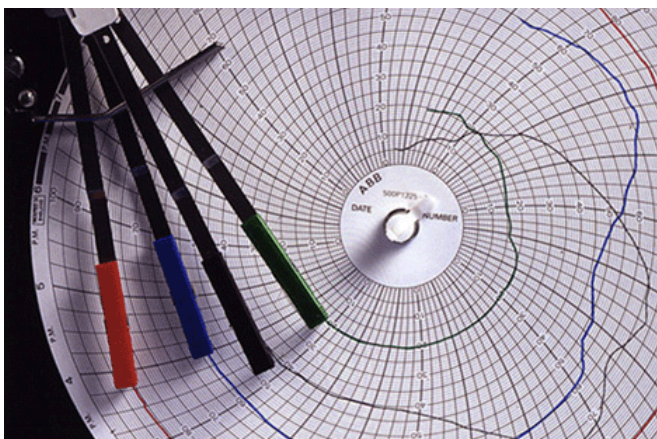

Straightforward Operation

The clearly-labelled tactile keypads permit operator adjustments and configuration programming without the need to open the recorder's door. Separate operator panels for each controller provide a direct route for accessing individual control loops. Clear text prompts on the digital displays guide the user around the various menus. A password-protected security system prevents unauthorized access to configuration adjustment menus.

Flexibility to Solve Problems

The C1900 offers seamless integration of loop functionality to solve process problems, eliminating the need for auxiliary devices.

Totalizers, Math, Logic and Timers

Integrating fluid flow to calculate total volume is performed by the built-in totalizers, available for each channel. Relays can be assigned to increment or reset external counters to match the recorder's totalizer values.

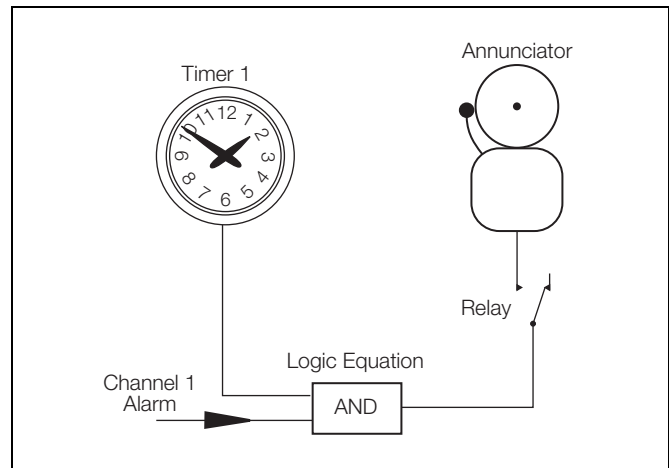

Alarm annunciation enabled during night hours only

User configurable **math functions**, mass flow calculations, RH tables and **logic equations** are all fully supported. The C1900 also offers two event timers driven by the recorder's **real-time clock**.

MODBUS RS485 Communications

Communications with PCs or PLCs are achieved via the RS485 serial communications link. Using MODBUS RTU protocol, all process inputs and other variables can be continuously read by a host PC running any of a wide variety of standard SCADA packages.

Versatile Process Control

The C1900 provides full PID control of one or two process loops in addition to its powerful recording facilities. The control loops can operate independently or be soft-linked together to implement Cascade or Master/Slave control strategies. Each loop has a dedicated 1/4 DIN-style operator panel for ease of operation and clarity of display.

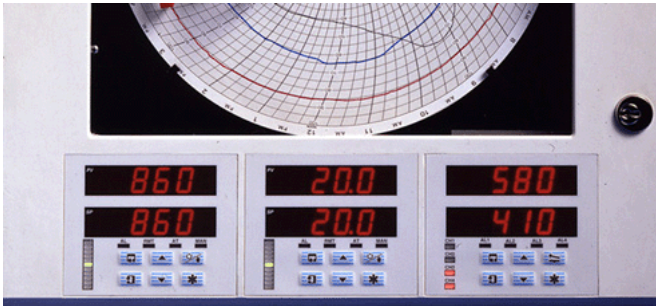

Analog, Relay or Valve Positioning Output

The control output is selectable to fit any application with a choice of analog, time proportioning or valve positioning relays; use of a **feedback potentiometer** to ensure precise valve control is fully supported. Heat/cool operation is available on both loops.

Autotune

Operation of the autotune function on either loop instigates a tuning routine which allows the C1900 to calculate the optimum PID parameters for that particular loop. Following the completion of autotune, the PID values are automatically updated.

Auto/Manual and Local/Remote

Dedicated membrane keys on each operator panel enable one-touch operation for selection between manual and automatic loop control and for switching from local to remote set point.

Extensive Ramp/Soak Programming

Full control of temperature profiles is provided by 10 program recipes for each controller. A total of 99 ramp/soak segments are available for allocation to these programs. Segment events can be incorporated into the recipes to perform specific functions (e.g. operate relays) at predefined points within the program.

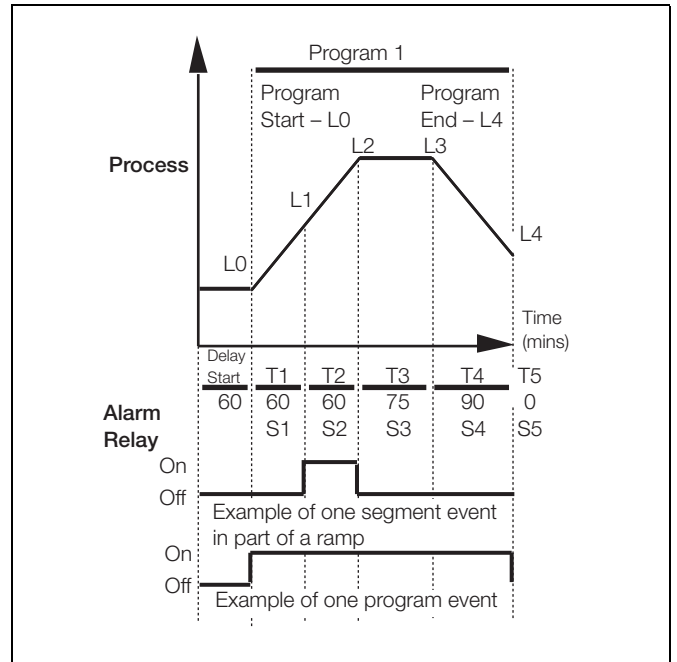

Ramp/Soak Program with Time Event Relay Sequences

Remote Program Selection

External panel switches can be connected to the C1900's digital inputs to allow remote selection of stored profiles and to initiate ramp/soak programs.

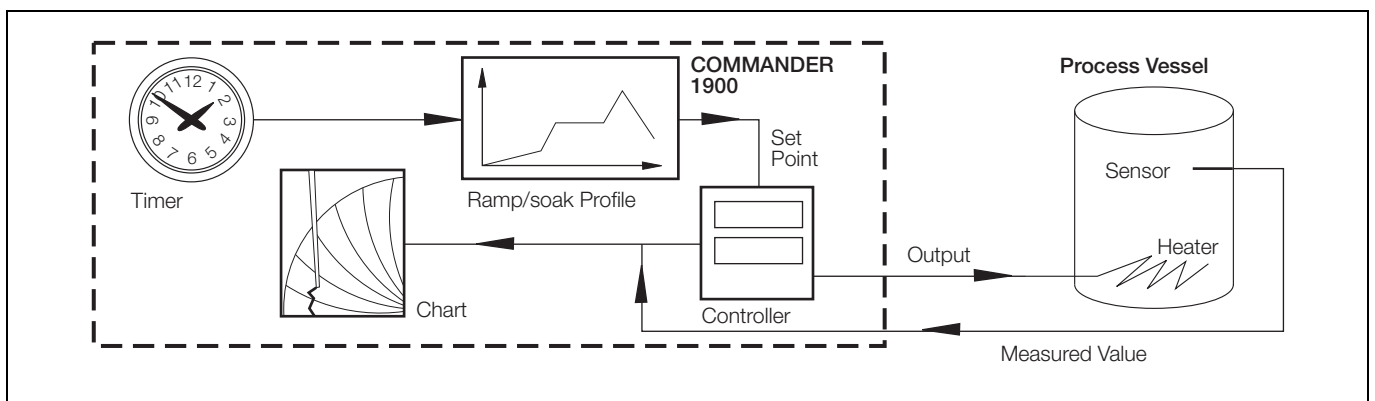

Programmed process warm-up triggered by real-time clock

Built to Meet Your Needs

The C1900's modular architecture gives a high level of hardware choice: up to five I/O modules can be added to the basic instrument.

The standard input/output module supplied with every pen comes complete with a fully isolated analog input, a relay output, transmitter power supply, isolated analog output and two digital inputs. Further input and output capability is provided by a range of plug-in modules:

- **Analog input and relay** – remote set point
- **Four relays** – channel alarm outputs
- **Eight digital inputs** – linked using logic equations
- **Eight digital outputs** – TTL level alarm outputs
- **MODBUS RS485 communications** – interfaces with PCs

Expandable for the Future

The C1900 may be quickly upgraded to meet your changing process requirements.

Additional recording channels, math capability or input and output functions can be retrofitted on-site using plug-in cards and easily fitted pen arms. Input calibration data is stored on each card, allowing quick changes to input cards without the need for recalibration.

Changes to input sensors or recording procedures are accommodated by reconfiguration using the main keypad.

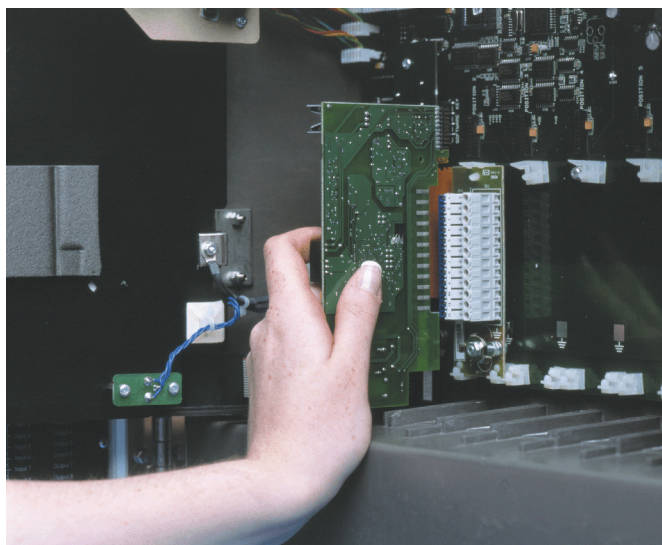

Designed to Survive

NEMA 4X protection ensures the C1900 can survive in the harshest environments and makes the recorder ideal for use in panels which are regularly hosed down. The tough, acid-resistant case and secure cable-entry glands maintain the NEMA 4X rating for wall-mounted or pipe-mounted instruments.

Noise Immunity

Recording accuracy is maintained in noisy industrial environments due to the advanced EMC shielding within the recorder. The power supply has been designed to give excellent protection from power spikes and brownouts and all configuration and status information is held in nonvolatile memory to ensure rapid recovery after a power failure.

Easy to Install

A choice of mounting options enables simple installation of the recorder in a panel, on a wall or on a pipe. Detachable terminal blocks allow for trouble-free connection of input and output wiring, with mains isolation provided by an optional power switch within the instrument.

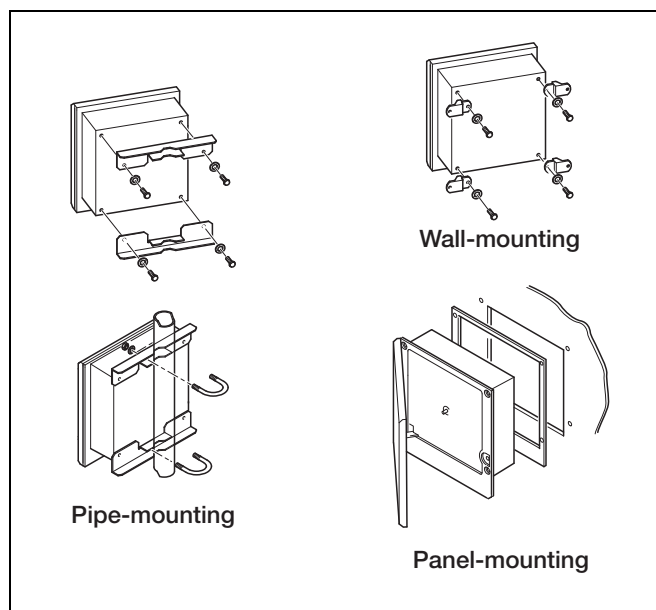

Minimal Maintenance

Excellent long-term stability keeps recalibration to a minimum, cutting the costs of ownership. User-selectable chart speeds and long-life pens combine to limit usage of consumables.

Built-in Quality

The C1900 is designed, manufactured and tested to the highest quality standards, including ISO 9001, and is guaranteed by a 2 year parts and labour warranty.

Specification

Summary

- 1, 2, 3 or 4 pens
- 1 or 2 PID control loops
- 10 in. Chart size
- Standard I/O with each pen includes:
- Analog input, analog output, transmitter power supply, relay output and 2 digital inputs.

General Specification

Construction

Size	386.8 x 382.0 x 141.5 mm (15.23 in. [h] x 15.04 in. [w] x 5.57 in.[d])
Weight	8.2 kg (18 lb)
Case material	Glassfiber-filled reinforced polyester
Window Material	Polycarbonate
Door latch	High-compression with optional lock

Environmental

Operational temperature range	0 ... 55 °C (32 ... 130 °F)
Operational humidity range	5 ... 95 % RH (non-condensing) 5 ... 80 % RH (chart only)
Case sealing	NEMA 4X (IP66)
Fast transients	IEC 801-4 Level 3

Installation

Mounting options	Panel, wall or pipe
Terminal type	Screw
Wire size (max.)	14 AWG (I/O), 12 AWG (power)

Operation and Configuration

Programming method	Via front panel keys
Security	Password protected menus

Safety

General safety	IEC348
Isolation	500 V DC (channel/channel) 2 kV DC (channel/ground)
Memory protection	Nonvolatile EEPROM
Approvals	CSA UL CSA/FM Class 1 Div. 2 CE

Power Supply

Voltage	100 ... 240 V AC \pm 10 % (90 V min. ... 264 V max. AC), 50/60 Hz
Consumption	< 30 VA (typical for full spec. unit)
Line interruption	Up to 60 ms

Analog Input Performance

Type	Range Lo	Range Hi	Min. Span	Accuracy
mV	0	150	5	\pm 0.1 % reading or 10 μ V
V	0	5	0.1	\pm 0.1 % reading or 20 mV
mA	0	50	1	\pm 0.2 % reading or 0.2 μ A
Ω (high)	0	10 k	400	\pm 0.5 % reading or 0.1 Ω
Ω (low)	0	10 k	400	\pm 0.5 % reading or 10 Ω

Type	°C			°F			Accuracy (excl. CJC)
	Range Lo	Range Hi	Min. Span	Range Lo	Range Hi	Min. Span	
B	-18	1800	1278	0	3270	710	\pm 2 °C (above 200 °C)
E	-100	900	81	-140	1650	45	\pm 0.5 °C
J	-100	900	90	-140	1650	50	\pm 0.5 °C
K	-100	1300	117	-140	2350	65	\pm 0.5 °C
N	-200	1300	162	-325	2350	90	\pm 0.5 °C
R	-18	1700	576	0	3000	320	\pm 1 °C (above 300 °C)
S	-18	1700	576	0	3000	320	\pm 1 °C (above 200 °C)
T	-250	300	108	-400	550	60	\pm 0.5 °C
PT100	-200	600	45	-325	1100	25	\pm 0.5 °C

Process Inputs and Outputs

General

Noise Rejection	Common mode > 120 dB at 50/60 Hz Normal (series) mode > 60 dB at 50/60 Hz
CJC rejection ratio	0.05 °C/°C
Sensor break protection	Upscale or downscale drive
Out of range detection	0 ... 100 % of engineering span
Temperature stability	< 0.02 % of reading/°C or 1 µV/°C
Long-term drift	< 0.01 % of reading 10 µV annually
Input impedance	> 10 MΩ (mV and V inputs) 39 Ω (mA inputs)

Analog Inputs

Signal types	mV, V, mA, Ω
Thermocouple types	B, E, J, K, N, R, S, T
Resistance Thermometer	Pt100
Other linearizations	x ^{1/2} , x ^{3/2} , x ^{5/2} , linear
Sample interval	250 ms per channel
Isolation	500 V DC channel/channel
Digital Filter	0 ... 60 s programmable

2-Wire Transmitter Power Supply

Number	1 per channel
Voltage	24 V DC nominal
Drive	Up to 25 mA
Isolation	500 V DC channel/channel

Analog Outputs

Type	4 ... 20mA
Accuracy	± 0.1 %
Maximum load	750 Ω
Isolation	500 V DC

Relay Outputs

Type	SPDT
Rating (with non-inductive load)	5 A at 115/230 V AC

Digital Inputs

Type	TTL or volt-free
Minimum pulse	250 ms
Isolation	500 V DC between modules, no isolation within module

Digital Outputs

Type	5 V TTL
Rating	5 mA per output
Isolation	500 V DC between modules, no isolation within module

Serial Communications

Connections	RS485, 4-wire
Protocol	MODBUS RTU

Recording System

Pens

Number	1, 2, 3, or 4 (red, blue, green, black)
Response	7 s (full scale)
Resolution	0.1 % steps
Pen lift	Motor-driven, with optional auto-drop

Event Pens

Standard	3-position event recording on any channel
Real time	3-position event recording on the same time line as Pen 1

Chart

Chart size	Approx. 254 mm (10 in.) diameter.
Chart speed	1 ... 167 hours or 7 ... 32 days per revolution
Rotation accuracy	<0.5% of rotation time

Display and Operator Panels

Displays

Number	Dual display for process value and set point for each controller, plus individual display for each record-only channel
Type	6-digit red LED, 14 mm (0.56 in.) high
Status indicators	Indicate channel number on display (on record-only channel) Indicate remote set point, autotune or manual operation
Alarm indicators	Indicate channels with active alarms

Panel keys

Function	Programming access, increment/decrement, auto/manual, pen lift and user-defined function key.
----------	---

Alarms and Logic

Alarms

Number	4 per channel
Type	High/low process, fast/slow rate of change, deviation high/low, output high/low, high/low process time delay
Adjustments	Hysteresis, time delay

Logic Equations

Number	8
Function	OR, AND
Inputs	Alarm states, digital inputs, totalizers, logic
Outputs	Relays, digital outputs, chart stop, alarm acknowledge

EMC

Design & Manufacturing Standards

CSA General Safety	Approved
UL General Safety	Approved
CSA/FM Class 1 Div. 2	Approved

Emissions and Immunity

Meets requirements of:
EN 50081-1
EN 50082-2
IEC 61326 for an Industrial Environment
CE Mark

Advanced Software Functions

Totalizers

Number	1 per pen
Size	99999999 max.
Output	External counter driver, 'wrap' pulse signal

Math

Number of eqns.	4
Type	+, -, x, ÷, low & high select, max., min., average, mass flow, RH

Timers

Number	2
Size	Real-time clock driven event, adjustable duration
Output	Relay, digital output, logic equation

PID Control

No. of loops	1 or 2
Control outputs	Relay, logic or DC analog
Control types	Time-proportioning, analog
Control action	PID, on/off, motorized valve position, boundless
Autotune	On demand, at start-up or at set point

Option Modules

Number	5 plus 1 x standard input/output module
Connection	Plug-in cards with detachable connection blocks

General

All modules isolated from each other 500 V DC

Module specific

Analog O/P isolated from all other I/Ps and O/Ps
Common of digital I/Ps not isolated from -ve of PV I/P.

Option Module Types

Option Module Types	I/O per module							Max. no. per instrument
	Analog I/P	Analog O/P	Trans. PSU	Relays	Digital I/P	Digital O/P	Comms.	
Standard I/O	1	1	1	1	2			3
Analog I/P + relay	1			1				5
4 relays				4				2
8 digital I/P					8			3
8 digital O/P						8		3
RS485 communications							1	1

Overall Dimensions

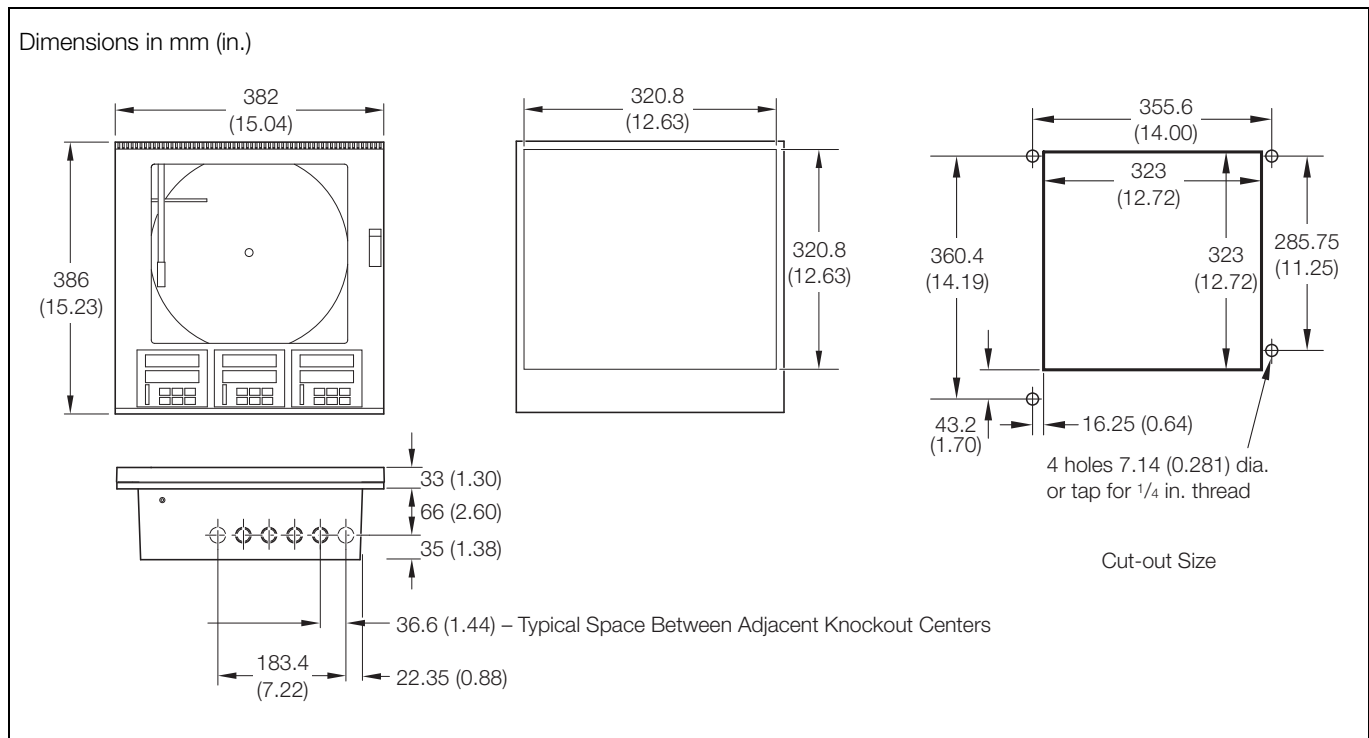

Electrical Connections

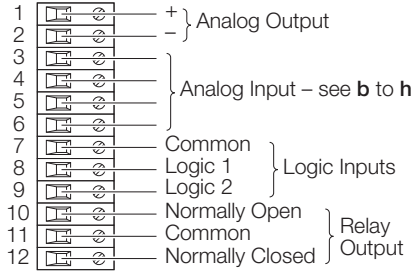

Summary of Connections

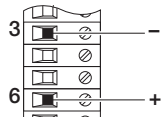

b - Voltage

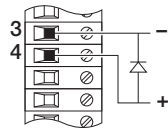

c - Current
(non 2-wire Transmitters)

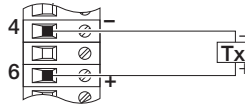

d - 2-wire Transmitter

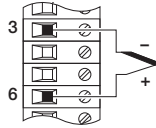

e - Thermocouple

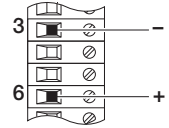

g - Low Voltage (mV)

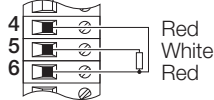

f - 3-wire RTD

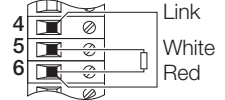

h - 2-wire RTD and Resistance

Standard Input/Output Modules

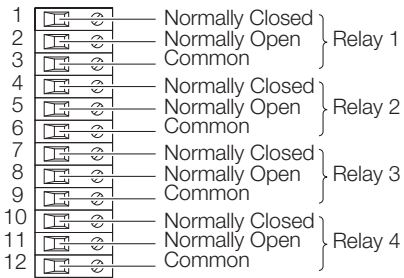

Four-Relay Output Module

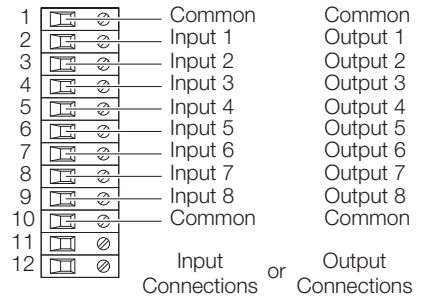

Digital Input/Output Module

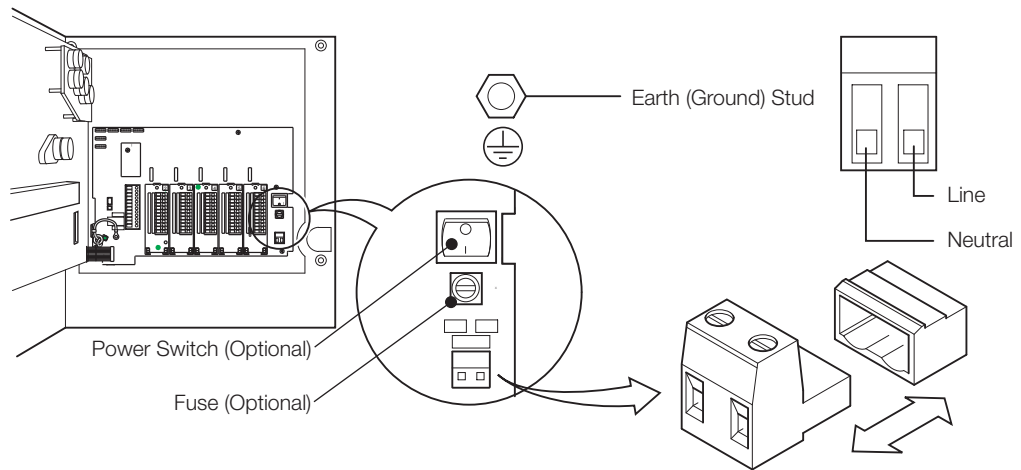

Power Supply Connections

Ordering Information

PART 1

C1900 Recorder/Controller		19 XX	X	X	X	X	X	X	X	X	X	X	X	XXX
Recorder / Controllers *	One Control Unit, One Pen (Red)	11												
	One Control Unit, Two Pens (Red, Green)	12												
	One Control Unit, Three Pens (Red, Green, Blue)	13												
	One Control Unit, Four Pens (Red, Green, Blue, Black)	14												
	Two Control Units, Two Pens (Red, Green)	22												
	Two Control Units, Three Pens (Red, Green, Blue)	23												
	Two Control Units, Four Pens (Red, Green, Blue, Black)	24												
Chart Type	Taylor ER/C charts		R											
	KPC 105 PX and PXR type charts		S											
	Chessell Brand charts		D											
Electrical Code	Standard			A										
	CSA approved			B										
	UL approved			U										
	CSA/FM Class 1 Div. 2 approval			F										
Option Module	None				0									
	Additional Modules – Complete PART 2				A									
Options	None					0								
	Totalizer					3								
	Ramp/Soak Profile					5								
	Math & Timer					A								
	Totalizer, Math & Timer					B								
Totalizer, Ramp/Soak Profile, Math & Timer					C									
Door Lock	Not Fitted						1							
	Fitted						2							
Power Supply	115 V AC							1						
	230 V AC							2						
	115 V AC with On/Off Switch							4						
	230 V AC with On/Off Switch							5						
Special Settings	Company Standard													STD
	Customer Setting													CUS
	Special													SXX

* Each pen fitted has an associated standard Input/Output module comprising Analog Input, Analog Output, Relay, Transmitter Power Supply and Two Digital Inputs.
Additional Input/Output modules may be fitted in the unused Module Positions as required. These additional modules should be specified in PART 2 of the Ordering Guide.

PART 2 Additional Modules	Module Type					
Module Position 2/Channel 2 Input*	0	1	2			
Module Position 3/Channel 3 Input*	0	1	2			
Module Position 4/Channel 4 Input*	0	1	2	3	4	5 6
Module Position 5	0	2	3	4	5	
Module Position 6	0	2	4	5	8	

Accessories

Case-to-panel gasket	C1900/0149
Wall-mount kit	C1900/1712
Pipe-mount kit	C1900/0712
Pack of Red Pens	C1900/0121
Pack of Green Pens	C1900/0122
Pack of Blue Pens	C1900/0120
Pack of Black Pens	C1900/0119
Pack of Purple Pens	C1900/0123

Contact us

ABB Limited

Process Automation

Howard Road

St. Neots

Cambridgeshire PE19 8EU

UK

Tel: +44 (0)1480 475321

Fax: +44 (0)1480 217948

ABB Inc.

Process Automation

125 E. County Line Road

Warminster

PA 18974

USA

Tel: +1 215 674 6000

Fax: +1 215 674 7183

www.abb.com

Note

We reserve the right to make technical changes or modify the contents of this document without prior notice. With regard to purchase orders, the agreed particulars shall prevail. ABB does not accept any responsibility whatsoever for potential errors or possible lack of information in this document.

We reserve all rights in this document and in the subject matter and illustrations contained therein. Any reproduction, disclosure to third parties or utilization of its contents in whole or in parts – is forbidden without prior written consent of ABB.

Copyright© 2011 ABB

All rights reserved

3KXR200104R1001