

Analyze^{IT}

Continuous Gas Analyzer

AO2000-Caldos17

Thermal Conductivity Gas Analyzer

in the Version for Monitoring Hydrogen-Cooled Turbo Generators

**Operator's Manual
(Condensed Version)**

41/24-1021 EN Rev. 2

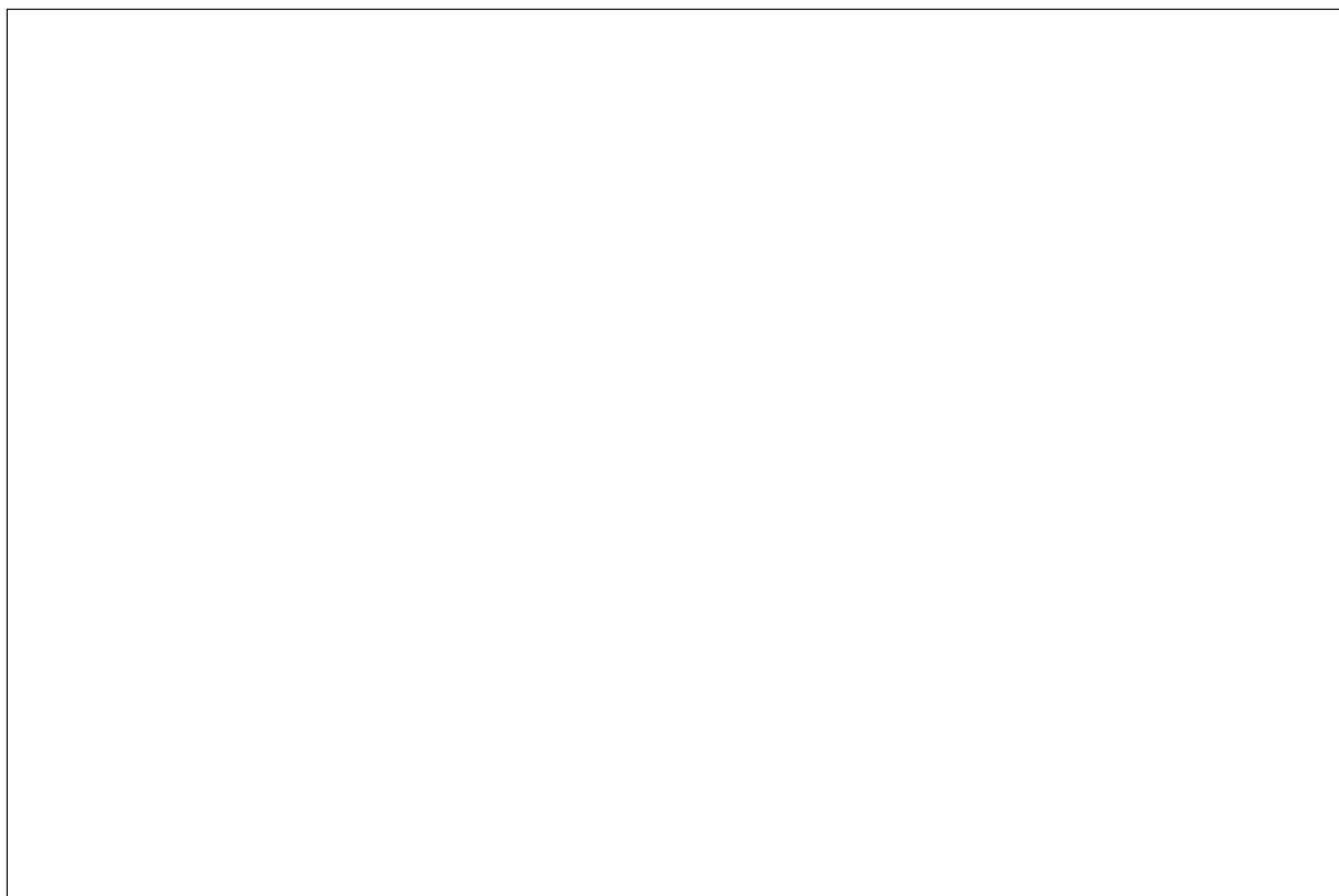

Contents

	Page
Part 1	
Operation	
Switching the Sample Component	3
Operation	4
Menu Tree	7
Manual Calibration	8
Calibration Reset	9
Selecting the User Interface Language	10
Changing the Password	11
Part 2	
Description	
Configuration	12
Analyzer Module Dimensional and Connection Diagram	13
Electronics Module Connections	14
Connection Diagrams	15
System Bus and 24 VDC Connections	17

Preface

Content of the Operator's Manual (Condensed Version)

This operator's manual (condensed version) is an extract from the comprehensive operator's manual for the AO2000 Series Continuous Gas Analyzers. It contains the essential information you will need to operate the AO2000-Caldos17 Thermal Conductivity Gas Analyzer in the Version for Monitoring Hydrogen-Cooled Turbo Generators.

Symbols Used in this Manual



Identifies safety information to be heeded during gas analyzer operation in order to avoid risks to the operator.



Identifies specific information on operation of the gas analyzer as well as on the use of this manual.

This Operator's Manual is protected by copyright. The translation, duplication and distribution in any form, even in a revised edition or in extracts, in particular as a reprint, by photomechanical or electronic reproduction or in the form of storage in data processing systems or data networks are prohibited without the consent of the copyright holder and will be prosecuted under civil and criminal law.

Switching the Sample Component

Figure 1
Front View of the
Central Unit

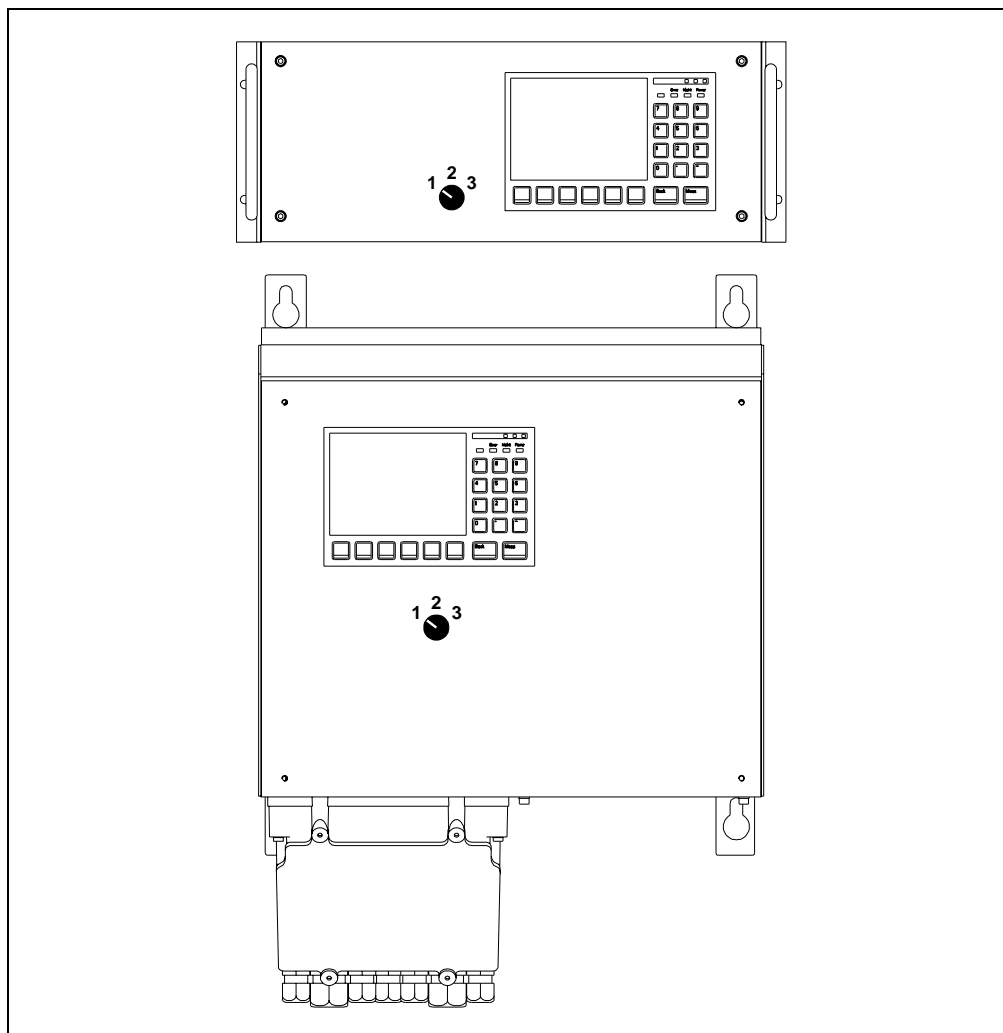

Switching the
Sample Component





Switch Position	Sample Component	Turbo Generator Operating State	
	0...100 Vol.-% CO ₂ or Argon in Air	Filling:	Displacement of air by CO ₂ or Argon
		Emptying:	Displacement of CO ₂ or Argon by air
	100...0 Vol.-% H ₂ in CO ₂ or Argon	Filling:	Displacement of CO ₂ or Argon by H ₂
		Emptying:	Displacement of H ₂ by CO ₂ or Argon
	80...100 Vol.-% H ₂ in Air	Working:	Monitoring of H ₂ purity

Figure 2
Display and Control Unit

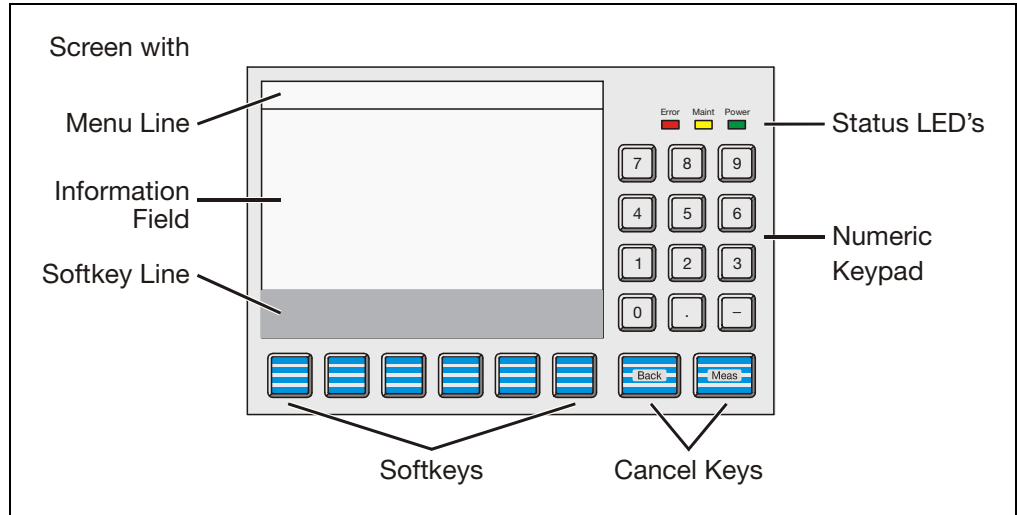

Status LED's

The three LED's next to the screen indicate the gas analyzer's status.

Power Green LED: The power supply is on.

Maint Yellow LED: The "Maintenance Request" status signal is active.

Error Red LED: The "Failure" status signal or the overall status signal is active.

Cancel Keys

The "Back" and "Meas" keys located under the numeric keypad are designated as cancel keys.



The "Back" key allows the operator to cancel a function or menu item and to return to the previous menu level.



The "Meas" key allows the operator to cancel a function or menu item and to return to the measured value display in measurement mode.

Only entries confirmed with the ENTER key are stored; unconfirmed items are not accepted.

Continued on next page

Softkeys

The six keys under the screen and the softkey line at the lower edge of the screen are known as softkeys.

A softkey is the combination of the key and its designation in the softkey line.

A softkey does not have any set function, but is assigned a function for a given situation as shown in the softkey line of the screen.

Pressing a softkey is the equivalent of pressing the key assigned to the function; this process is illustrated by the quasi-three-dimensional softkey representation on the screen.

Softkeys are also called keys in this manual.

The Softkeys in Measurement Mode

The softkeys  and  appear in measurement mode.

The  softkey also appears if an error occurs.



The **MENU** key is used to call the main menu and switch to menu mode when in measurement mode.



The **>>** key allows the operator to scroll to the next display “page”. This key only allows forward scrolling.

The “Back” key is used for backward scrolling.



The **STATUS MESSAGE** key appears in measurement mode if an “Failure” or “Maintenance request” condition arises.

This key allows the operator to call up the status message log and view the status messages.

The user can also call up a detailed display for any message in the log.

Continued on next page

The Softkeys in Menu Mode

In menu mode, a series of softkeys appears on the softkey line. Their descriptions and functions depend on the specific situation.

In menu mode the standard softkeys have the following functions:



The operator uses these two arrow keys to move the selection cursor up or down in a menu or list to choose menu items.

The item selected is reversed, i.e. appearing as bright characters on a dark background.



The operator uses these two keys to move the selection cursor left or right, e.g. into or out of a submenu or to select an item in a subordinate list.

The item selected is reversed, i.e. appearing as bright characters on a dark background.



The operator can use the **BACKSPACE** key to delete characters to the left of the cursor (as in a PC keyboard).



The operator can use the **CLEAR** key to delete all characters in a selected field.



The operator can use the **ENTER** key to:

- Call up menu items for processing
- Start functions
- Confirm entries, e.g. parameter settings

The **ENTER** key is always at the right margin of the softkey line.



The operator can use the **HELP** key to access context-sensitive help. The screen will then show a help message explaining the menu item selected.



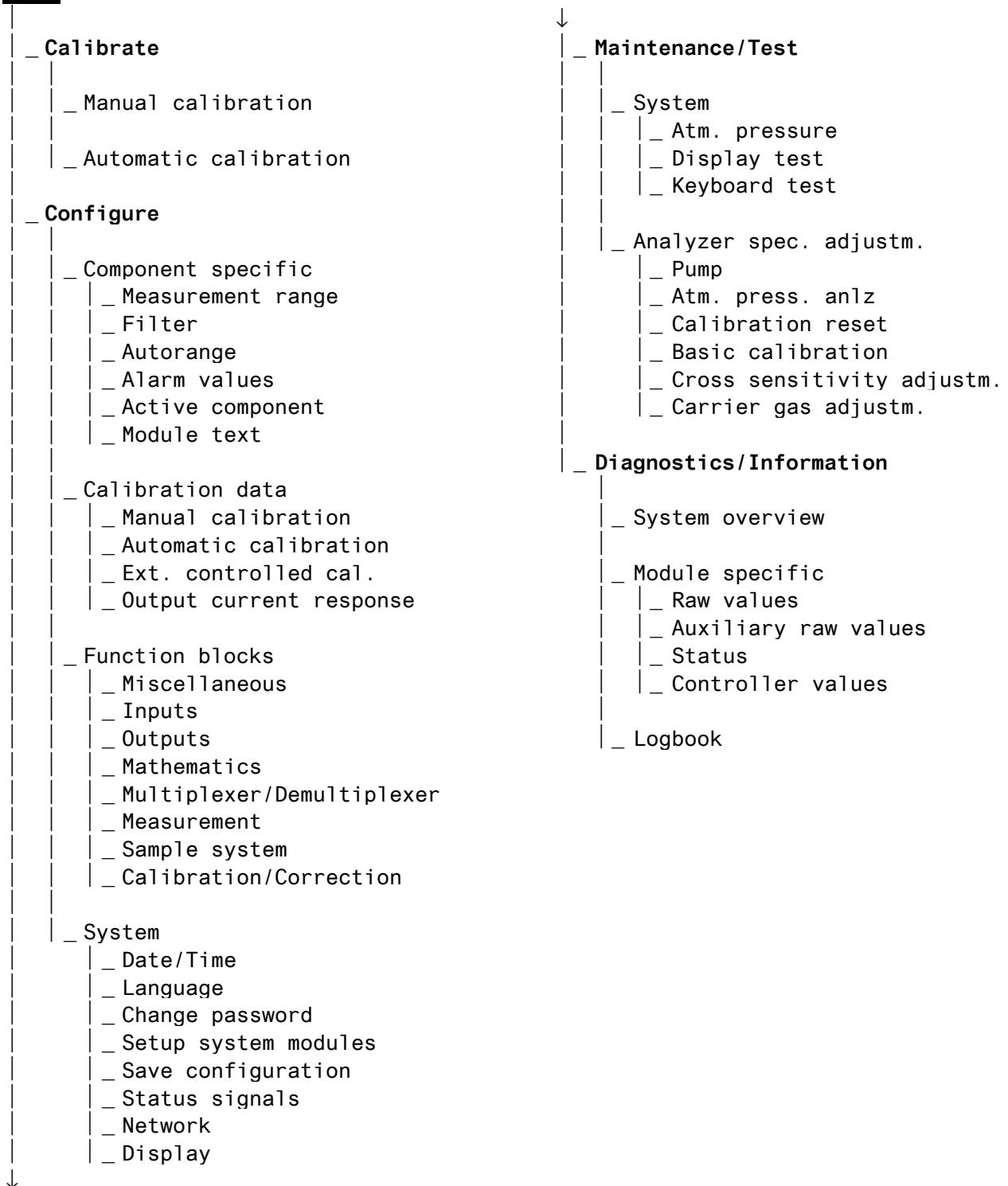

The operator can use the “Back” key to clear the help message.

Menu Tree

Menu



Manual Calibration

Manual Calibration	Step	Action	Input/Key
	1	Select the Manual Calibration menu.  Substitute gas calibration using sample component 2 (100...0 Vol.-% H ₂ in CO ₂ /Argon) must be set as calibration method. Zero: 100 Vol.-% H ₂ Span: 0 Vol.-% H ₂	MENU ↓ Calibrate ENTER ↓ Manual Calibration ENTER
Zero calibration:			
	2	Select Zero gas menu item.	Zero Gas ENTER
	3	Turn on the zero gas supply (H ₂) and confirm.	ENTER
	4	If necessary, change the test gas concentration ¹⁾ according to the specification on the H ₂ cylinder with the numeric keypad (example).	99.9 Vol% ENTER
	5	When the measurement value indication stabilizes, initiate zero calibration.	ENTER
	6	Accept the calibration result (forward to step 7) or repeat calibration ²⁾ (back to step 4) or reject calibration (back to step 5).	ENTER or REPEAT or 
Span calibration:			
	7	Select Span gas menu item.	Span gas ENTER
	8	Turn on the span gas supply when H ₂ :CO ₂ is displayed: CO ₂ when H ₂ :Ar is displayed: Argon and confirm.	ENTER
	9	If necessary, change the test gas concentration ¹⁾ with the numeric keypad.	0.0 Vol% ENTER
	10	When the measurement value indication stabilizes, initiate span calibration.	ENTER
	11	Accept the calibration result (forward to step 12) or repeat calibration ²⁾ (back to step 9) or reject calibration (back to step 10).	ENTER or REPEAT or 
	12	Return to measurement value readout.	

1) The initialized test gas concentration is shown as the set point.

2) It may be necessary to repeat calibration if the measurement value is still not stable after calibration has been started. The subsequent process is based on the measurement value obtained in the previous calibration.

Calibration Reset

When should a calibration reset be performed?

A calibration reset should be performed if the gas analyzer can no longer be calibrated by normal means. A possible cause of this is calibration of the gas analyzer with the wrong test gases.

Calibration Reset

Step	Action	Input/Key
1	Select Calibration reset menu item.	MENU ↓ Maintenance/Test ENTER ↓ Analyzer spec. adjustm. ↓ Calibration reset ENTER
2	Select component.	^ or v ENTER
3	Start calibration reset.	CAL RESET ↓ YES
4	Enter password for access level 1.	471100 ENTER
5	The system performs the calibration reset.	CAL RESET
6	Return to measurement value readout.	



The gas analyzer should be calibrated after a calibration reset.

Selecting the User Interface Language

Selecting Language	Step	Action	Input/Key
	1	Select Language menu item.	MENU ↓ Configure ENTER ↓ System ↓ Language ENTER
	2	Select language.	< or > ENTER
	3	Enter password for access level 2.	081500 ENTER
		The system is loading the new language.	
	4	Return to measurement value readout.	

Changing the Password

Changing the Password	Step	Action	Input/Key
	1	Select Change password menu item.	MENU ↓ Configure ENTER ↓ System ↓ Change password ENTER
	2	Use the arrow keys to select the user group for which the password is to be changed (for example).	Maintenance ENTER
	3	Use the numeric keypad to enter the old 6-digit password (for example).	471100 ENTER
	4	Use the numeric keypad to enter the new 6-digit password (for example).	471200 ENTER
	5	Re-enter the new password (for example).	471200 ENTER
	6	Return to measurement value readout.	

Password Setting

The default passwords are shown in the following table. User-specific passwords can be entered into the right column.

User Groups	Access to Password Levels	Default Passwords	User-specific Passwords
Every user	0	None	
Maintenance team	0, 1	471100	
Specialist team	0, 1, 2	081500	

Configuration

Sample Components and Measurement Ranges	No.	Measurement ranges, sample components and associated gas
	1	0...100 Vol.-% CO ₂ or Argon in air
	2	100...0 Vol.-% H ₂ in CO ₂ or Argon
	3	80...100 Vol.-% H ₂ in air (80/85/90...100 Vol.-% or 100...90/85/80 Vol.-% according to order)

Input and Output Signals	Status signal output	Single status output via digital outputs on the digital I/O module "Status signals/Externally controlled calibration" (see Fig. 5)
	Sample component switch over and feed back	Digital inputs and outputs on the digital I/O module "Measuring range control" (see Fig. 6)
	Current output	Analog output AO1 on the analog output module, current range 4...20 mA (see Fig. 8)
Indication	1 decimal place	
Time Constant	T90 = 15 sec.	
Calibration	Substitute gas calibration using sample component 2 (100...0 Vol.-% H ₂ in CO ₂ /Argon) Zero: 100 Vol.-% H ₂ Span: 0 Vol.-% H ₂	

Analyzer Module Dimensional and Connection Diagram

Figure 3
Analyzer Module
Dimensional and
Connection Diagram
 (Dimensions in mm)

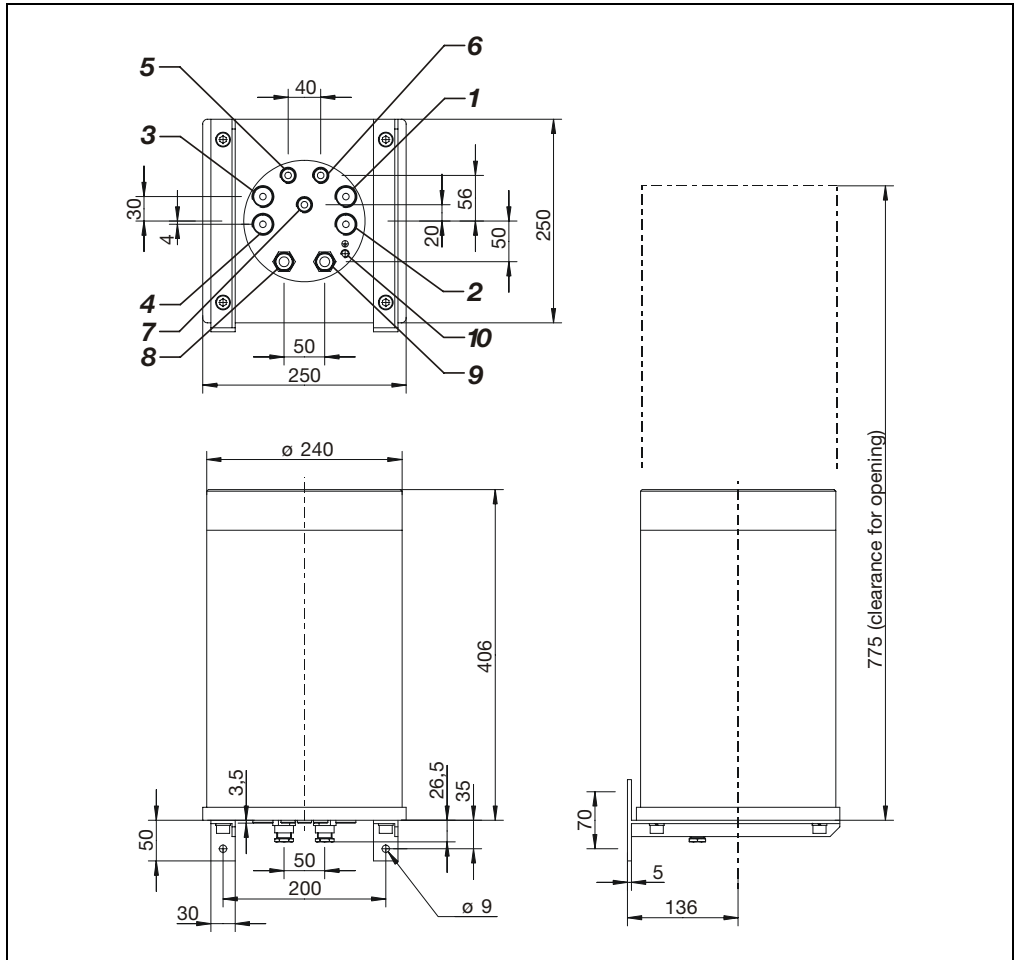

- Gas Connections:**
- 1** Sample gas inlet
 - 2** Sample gas outlet
 - 3** Vent opening ²⁾
 - 4** Vent opening ²⁾
 - 5** Purge gas inlet ¹⁾
 - 6** Purge gas outlet ¹⁾
 - 7** Pressure sensor

- Electrical Connections:**
- 8** System bus
 - 9** 24 VDC
 - 10** Potential compensation
- 1) Option
 2) only in version for sample gas under positive pressure

Electronics Module Connections

Figure 4
Electronics Module Connections

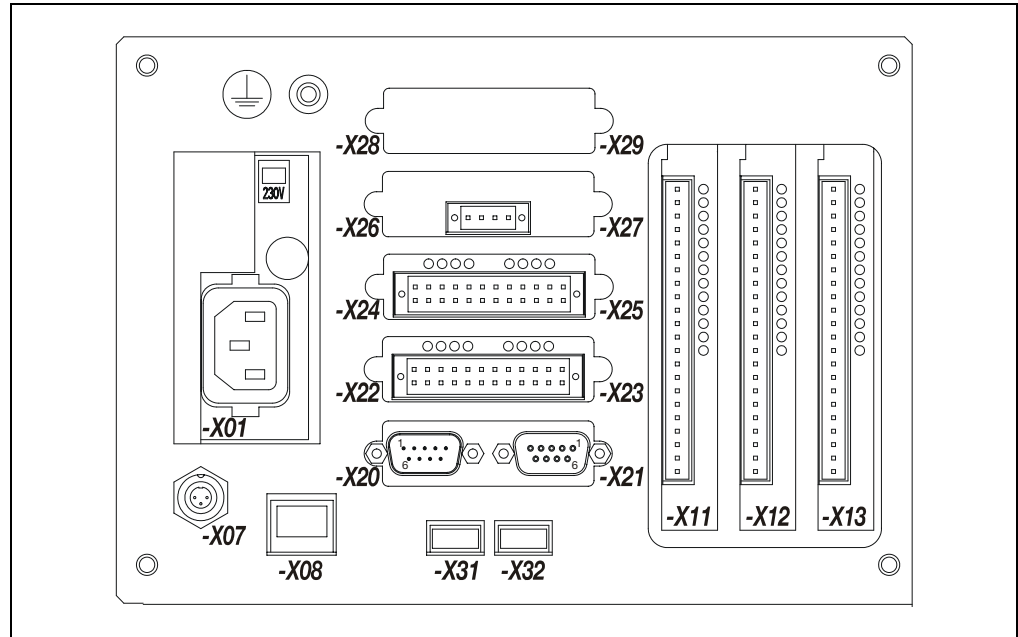

- X01** 115/230 VAC power supply connection
- X07** System bus connection
- X08** Ethernet 10/100BASE-T interface
- X20/-X21** RS232/RS485 module (option)
- X22/-X23** Digital I/O module “Status signals/Externally controlled calibration” (see Figures 5 and 7)
- X24/-X25** Digital I/O module „Measuring range control“ (see Figures 6 and 7)
- X26/-X27** Analog output module (see Figure 8)
- X31, -X32** not used
- X11...-X13** I/O boards (options)
- ⊕ Potential compensation connection

Connection Diagrams

Figure 5

**Digital I/O Module
"Status Signals/
Externally Controlled
Calibration"
Connection Diagram**

1	DI4 -	Abgleich Endpunkt
2	+	Adjust End Point
3	GND	
5	DI3 -	Abgleich Nullpunkt
6	+	Adjust Zero Point
4	GND	
7	DI2 -	Autokalibrierung sperren
8	+	Inhibit Automatic Calibration
9	GND	
11	DI1 -	Autokalibrierung starten
12	+	Start Automatic Calibration
10	GND	
13	DO4 NO	Externes Magnetventil
15	C	External Solenoid Valve
17	NC	
14	DO3 NO	Wartungsbedarf
16	C	Maintenance Request
18	NC	
19	DO2 NO	Funktionskontrolle
21	C	Maintenance Mode
23	NC	
20	DO1 NO	Ausfall
22	C	Failure
24	NC	

Figure 6

**Digital I/O Module
"Measuring Range
Control"
Connection Diagram**

1	DI4 -	nicht belegt
2	+	not used
3	GND	
5	DI3 -	Messkomponenten-Umschaltung H ₂ :Luft
6	+	Sample Component Switchover H ₂ :Air
4	GND	
7	DI2 -	Messkomponenten-Umschaltung H ₂ :CO ₂ oder H ₂ :Argon
8	+	Sample Component Switchover H ₂ :CO ₂ or H ₂ :Argon
9	GND	
11	DI1 -	Messkomponenten-Umschaltung CO ₂ :Luft oder Argon:Luft
12	+	Sample Component Switchover CO ₂ :Air or Argon:Air
10	GND	
13	DO4 NO	nicht belegt
15	C	not used
17	NC	
14	DO3 NO	Messkomponenten-Rückmeldung H ₂ :Luft
16	C	Sample Component Feedback H ₂ :Air
18	NC	
19	DO2 NO	Messkomponenten-Rückmeldung H ₂ :CO ₂ oder H ₂ :Argon
21	C	Sample Component Feedback H ₂ :CO ₂ or H ₂ :Argon
23	NC	
20	DO1 NO	Messkomponenten-Rückmeldung CO ₂ :Luft oder Argon:Luft
22	C	Sample Component Feedback CO ₂ :Air or Argon:Air
24	NC	

Continued on next page

Figure 7
Digital I/O Modules
Pin Layout

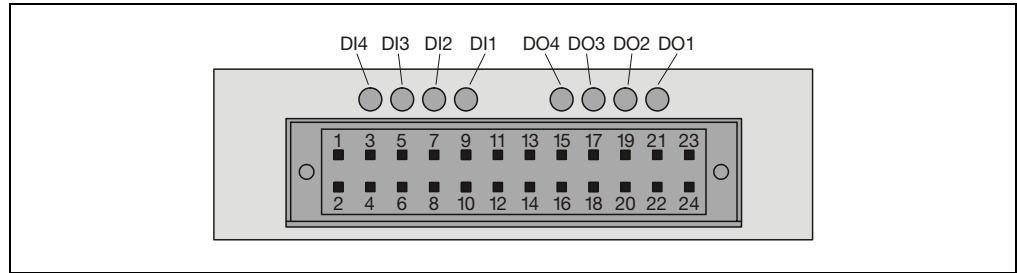
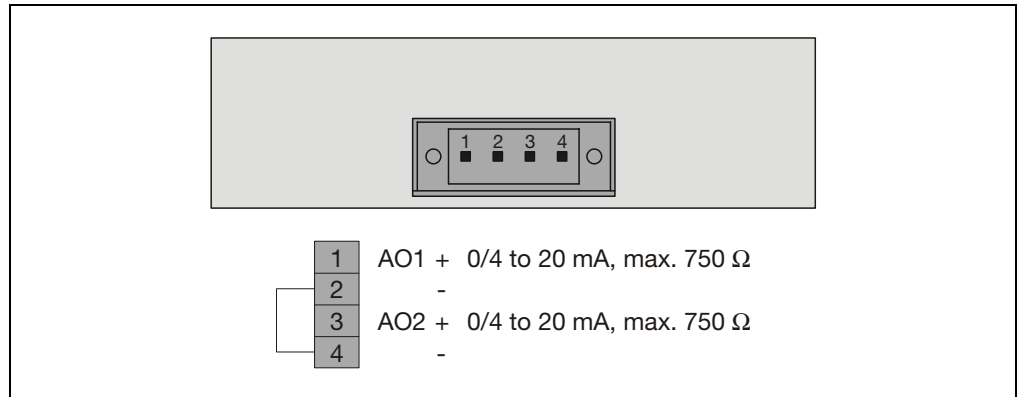
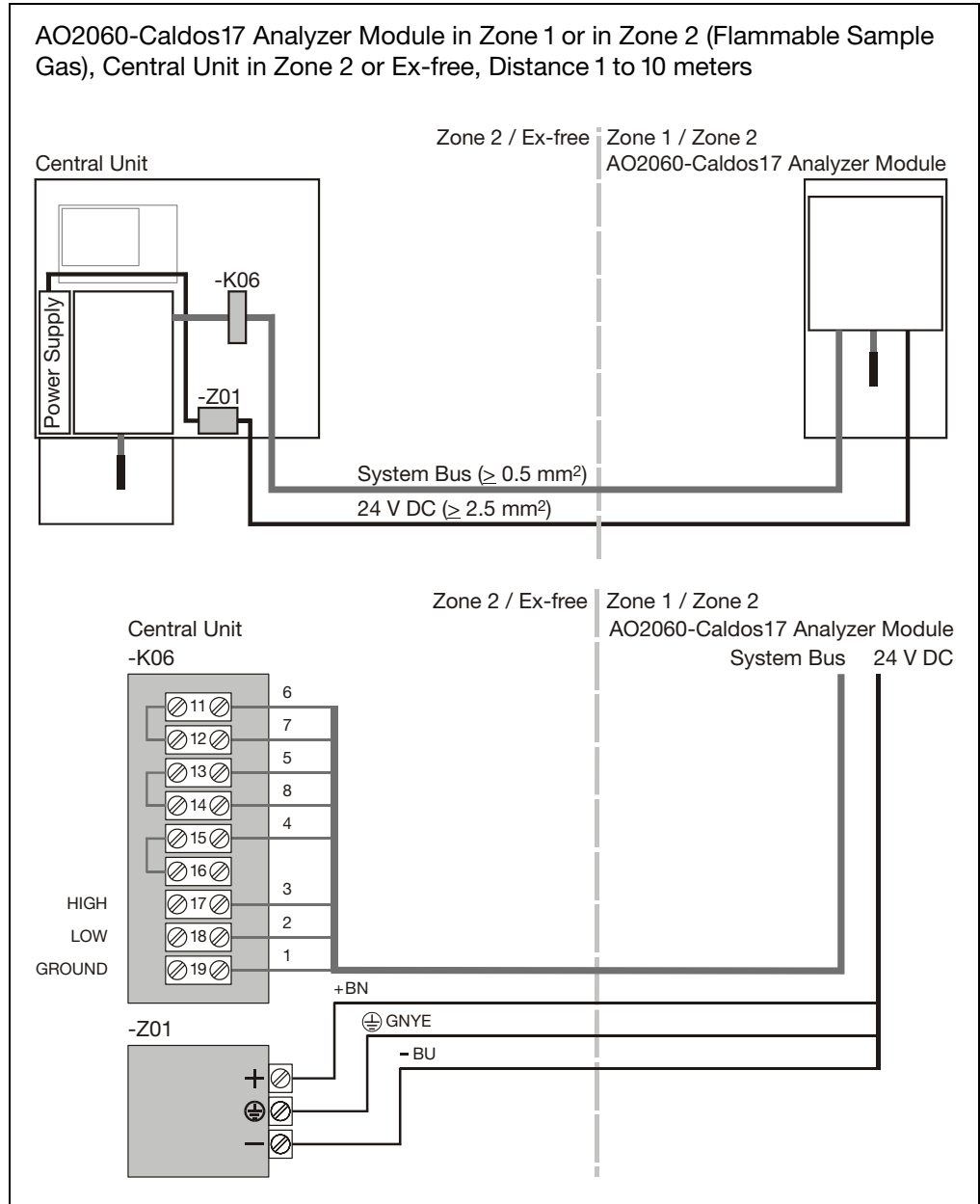

Figure 8
Analog Output
Module
Pin Layout and
Connection Diagram



System Bus and 24 VDC Connections

Figure 9
System Bus and
24 VDC Connections



The Industrial^{IT} word mark and all mentioned product names in the form XXXX^{IT} are registered or pending trademarks of ABB.

ABB has Sales & Customer Support expertise in over 100 countries worldwide.

www.abb.com



ABB Automation Products GmbH

Analytical Division

Stierstaedter Strasse 5

60488 Frankfurt am Main

Germany

Phone: +49 69 7930-40

Fax: +49 69 7930-4566

E-Mail: analytical-mkt.deapr@de.abb.com

The Company's policy is one of continuous product improvement and the right is reserved to modify the information contained herein without notice.

Printed in the Fed. Rep. of Germany (04.04)

© ABB 2004