

Aluminium conductors must not be connected

### **Conditions of Delivery and Sale**

For business conducted in domestic and foreign markets the following conditions in their latest versions are valid:

General conditions of Supply and Delivery for products and services of the electrical industry: Form 80060 German, 80061 German-English, 80062 German-French.

General conditions of Sale for the products and services of the electrical industry: Form 80175 German, 80160 English, 80174 French.

Relevant to specific orders special conditions can be agreed upon.

### **Guarantee**

The guarantee period is 6 months, in favour of the endbuyer, and commences when he is in possession of the products. In this connection, our valid guarantee conditions are included in the packing of our cordless tools.

### **Technical Reservations**

The data and figures of this publication are subject to change as required by technical progress.

---

# Residual Current-operated Circuit-Breakers F 804

---

## Contents

### General

Description, Functions .....	4
Electromagnetic compatibility .....	4
Influence of RCDs by smooth d.c. fault currents .....	5
Technical data .....	6

### Mounting and operating instructions

Mounting and operating instruction .....	7
Dimensions .....	8
Installation instruction .....	9
Influence from electronic equipment .....	10

### Selection table

Universal current sensitive RCD F 804 .....	11
---	----

# Residual Current-operated Circuit-Breakers F 804

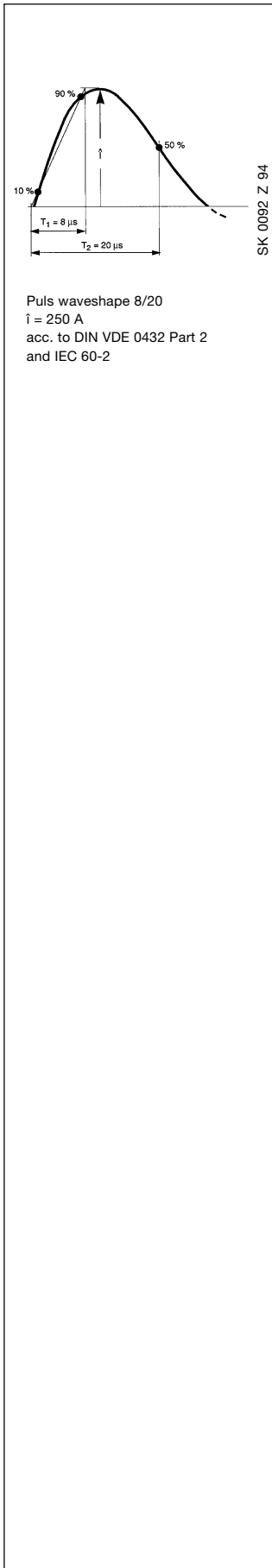

## Description

The Universal current sensitive RCD F 804 consists of two RCDs connected in series.

The first one works voltageindependantly, the second one is equipped with an electronic amplifier and operates voltagegedependant.

The first RCD covers a.c. and pulsating d.c. fault currents. The electronic one covers pulsating currents superimposed on smooth d.c. fault currents.

It detects:

- a.c. fault currents
- Pulsating d.c. fault currents
- Smooth d.c. fault currents (application in a.c./three phase mains together with electrical equipment which is provided with e.g. three phase bridge circuits or three phase star connections. If those circuits are faulty, a.m. earth leakage fault currents can occur).

The F 804 have a surge current withstand capacity at least 250 A (puls waveshape 8/20 according to DIN VDE 432 part 2 and IEC 60-2).

The universal current sensitive RCD, when combined with an upstream fuse gL 100 A are short circuit proof up to 10 kA non-inductive short-circuit current ( $\text{---}10000\text{---}$ )

The production and the RCD itself are halogen- and FCKW-free.

## Functions

### Protection against dangerous currents through the body

- in the event of touch voltage being to high due to bodily contact with the operating device (protection in the event of indirect contact with the service circuit).
- in the event of direct contact with a live conductor, when  $I_{\Delta n} \leq 300 \text{ mA}$  and where dangerous currents through the body need to be disconnected in shortest time (protection in the event of direct contact).
- protection against the occurence of electrically ignited fires (with  $I_{\Delta n} \leq 300 \text{ mA}$ ).

## Application

To achieve increased safety in all wiring installations (e.g. three phase bridge circuits or three phase star delta connections). Also in supply areas where the installation rules prescribe or recommend the use of residual current operated protective devices.

## Electromagnetic compatibility

- Immunity agaisnst electromagnetical fields fulfil level 3:  
Test filed intensity  $E \geq 10 \text{ V/m}$  acc. to DIN VDE 0843 part 3 IEC 801-3 in the enlarged frequency range 0,1 to 100 Mhz
- Immunity in comparison with transients acc. to IEC 801-4 level 4:  
4 kV peak value  
Fault tripping resistance: high immunity in comparison with transient leakage current, caused by switching processes with inductivity (e.g. motors) in long conductors.

# Residual Current-operated Circuit-Breakers F 804

## Protection ensured by types AC, A and B residual currents devices acc. to IEC 755 Amend. 2

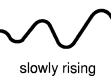
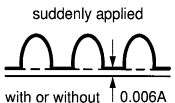
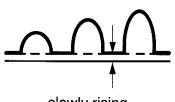
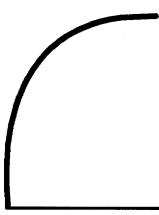

	Form of residual current	Correct functioning of residual current devices <sup>1)</sup>		
		Type		
		AC	A	B
Sinusoidal a.c.	 suddenly applied  slowly rising SK 0004 Z 96	+	+	+
	Pulsating d.c.	 suddenly applied with or without ↑ 0.006A  slowly rising SK 0002 Z 96		+
Smooth d.c.		 SK 0001 Z 96		

<sup>1)</sup> Indicated by +.

## Classification of the STOTZ-Residual Current operated Devices

Types		
AC	A	B
F 360 F 660	F 370 F 390 F 670 F 694	F 804
	F 270 P 270	
	F 402	

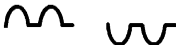
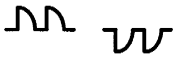
## The universal current sensitive RCD F 804 detects the following earth fault currents:







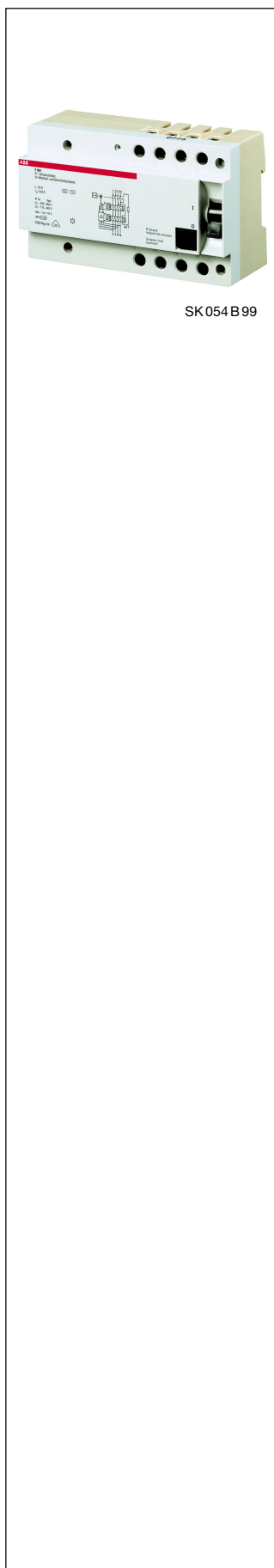



	a.c. fault currents
	Pulsating d.c. fault currents (pos. and neg. half cycle) half cycle current      0° el
	phase angle              90° el  phase angle              135° el
	Half cycle current superimposed on a smooth d.c. fault current of 6 mA
	Smooth d.c. fault current

SK 0083 Z94

# Residual Current-operated Circuit-Breakers F 804



## Technical data

Standard specification:	acc. to VDE 664 part 1, VDE-Register-No.  IEC 755
No. of poles:	4 pole
Rated current $I_n$ :	63 A
Rated residual operating current $I_{\Delta n}$ :	30 and 300 mA
Tripping range at 	0.50 ... 1.0 x $I_n$
at 	0.11 ... 1.4 x $I_n$
at 	0.50 ... 2.0 x $I_n$
Tripping time at 1 x $I_{\Delta n}$ 	≤ 200 ms
at 5 x $I_{\Delta n}$ 	≤ 40 ms
at 1 x $I_{\Delta n}$ 	≤ 200 ms
at 5 x $I_{\Delta n}$ 	≤ 40 ms
at 1 x $I_{\Delta n}$ 	≤ 200 ms
at 5 x $I_{\Delta n}$ 	≤ 40 ms
Surge current withstand capacity:	≥ 250 A (pulse waveshape 8/20)
Short-circuit withstand capacity:	10.000, in combination with an upstream fuse gL 100 A acc. to DIN VDE 0636 part 1 or EN 60 269-1 breaking range and operating class gG
Rated voltage $U_n$ :	~ 230/400 V
max. operating voltage $U_{Bmax.}$ :	1.1 x $U_n$
Operating voltage of test device $U_T$ :	175 ... 440 V ~
Insulation:	acc. to DIN VDE 0110 part 1 and 2
– overvoltage category:	IV
– pollution degree:	2
– surge voltage (1.2/50):	6 kV
– surge voltage (50/60 Hz):	2.5 kV
Frequency:	50 ... 60 Hz
Enclosure:	Moulded plastic; grey (RAL 7035)
Switch handle/test button:	black (RAL 9005)
Degree of protection:	IP 20; IP 40 in distribution board
Cover dimensions:	acc. to DIN 43 880 size 1
Depth:	55 mm
Connections:	individual connection
Cable cross section:	bottom/top: 1.5 ... 25 mm <sup>2</sup> multicore to flexible conductors
Terminals:	bottom/top: frame terminals with screw M 6
Life expectancy:	≥ 10.000 mechanicals operations
Climatic resistance acc. to IEC 1008:	damp heat, cyclic (28 cycles)
Ambient temperature:	$T_{min} - 25^\circ \text{C}$ ; $T_{max} + 40^\circ \text{C}$
Vibration resistance:	acc. to IEC 1008
Protection against unintentional direct touch:	acc. to DIN VDE 0106; part 100
Trip free:	yes
Weight:	see selection table

# Residual Current-operated Circuit-Breakers F 804

## Mounting and operating instructions

**1. Technical data:** see page 6.

**2. Mounting:** Installation in the disered position by means of snap-on fastening to DIN-rails to EN 50 022, 35 mm (see Fig. 1 and 2).

**Mounting and dismounting only allowed by an authorized electrician.**

**3. Connection:** The supply may be from top or bottom as required. Care should be taken to ensure a good, secure connection to the conductor. Maximum screwdriver torque 3 Nm. When the F 804 would be installed as a 3-pole RCD, the terminals 1, 3, 5 and 2, 4, 6 must connected, as well as to shunt the terminals 3 and N to ensure the test device function of the RCD.

**4. Operation:** The F 804 is switched ON ("I") and OFF ("O") by means of the black switch handle (see Fig. 3).

**5. Functional test:** For the functional test, switch the switch in the ON (I) position and when the black test pushbutton is pressed the RCD must trip immediately (the black switch handle jumps to the lower position, switch position "O").

**The functional test should be repeated every half year.**

**6. Testing the protective measures:** As well as the functional test of the RCD the effectiveness of the protective measures should be tested for compliance with the relevant specifications. The maximum permissible earthing resistances for the residual current-operated protective switching are:

Max. permissible touch voltage $U_L$	Max. permissible earthing resistance with rated residual operating current	
	30 mA	300 mA
25 V	833 $\Omega$	83 $\Omega$
50 V	1666 $\Omega$	166 $\Omega$

**7. Cleaning:** RCDs which my have become soiled during assembly work in the switchboard can be cleaned with a damp and soapy cloth. On no account should be used corrosive or similar solvents.

**8. Faults:** STOTZ Residual Current-operated Circuit-Breakers are high quality RCCBs which are subjected to careful adjustment and testing in the factory. In the event of damage (e.g. due to transport or storage) no repairs should be undertaken.

If the Residual Current-operated Circuit-Breaker trips immediately when being commissioned a check should be made for connections to earth in the downstream electrical circuits and the appliances connected to them. Any insulation faults between the neutral conductor and the protective conductor should be eliminated. If the Residual Current-operated Circuit-Breaker does not trip during the first functional test, a check, should then be made as to whether the test circuit has been correctly connected.

If the above causes have been eliminated or if the functional test has not been successful the Residual Current-operated Circuit-Breaker must be replaced.

In case of opening the RCD, the right to claim under guarantee expires.

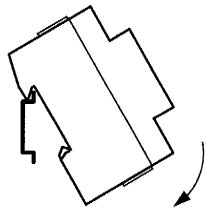

Fig. 1 Mounting

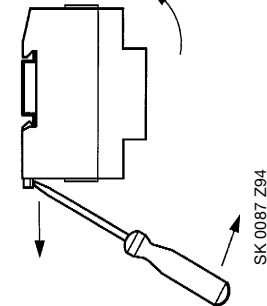

Fig. 2 Dismounting

SK 0087 Z94

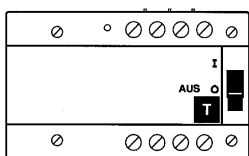
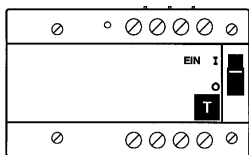
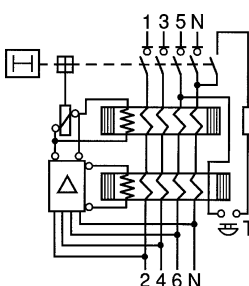

Fig. 3

SK 0091 Z94

### Connection diagramm



SK 0088 Z94

# Residual Current-operated Circuit-Breakers F 804

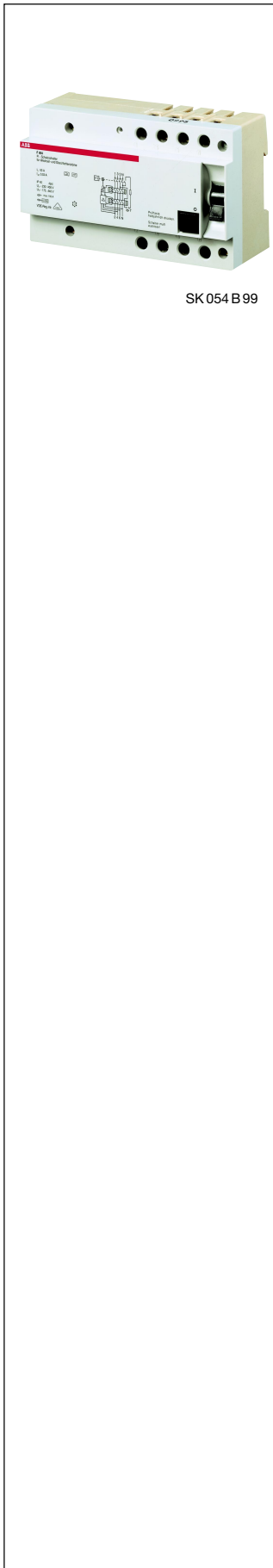

## Dimension drawings

Dimensions in mm

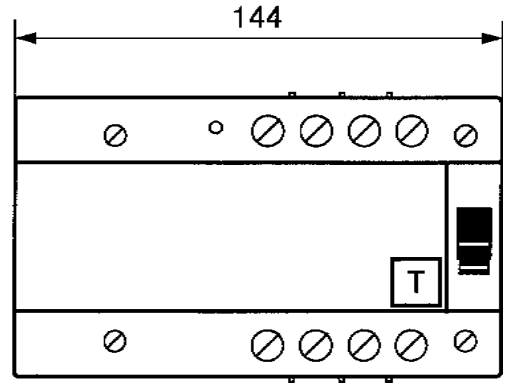
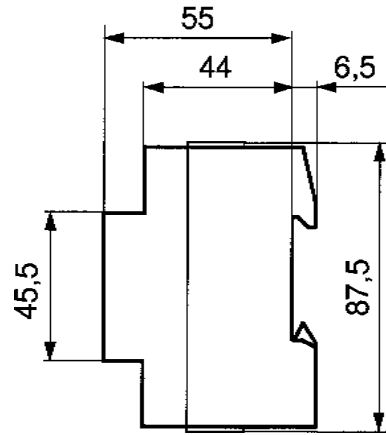

SK 0582 Z93

# Residual Current-operated Circuit-Breakers F 804

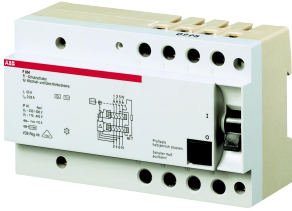

SK 054 B 99

## Notice for project and construction of electrical installations in which smooth and pulsating dc fault currents could arise (e.g. in connection with frequency converters or X-ray equipment).

For project and construction of electrical installations please notice that consumer – which could in the event of a defect produce smooth dc fault currents – must allocate a separate circuit with an universal current sensitive RCD. (see diagram below).

Smooth dc fault currents can seriously affect the tripping characteristics of the standards RCDs which are sensitive to pulsating dc fault currents (according to DIN VDE 0664). It is not allowed to install, after central ordered RCDs (acc. to DIN VDE 0664), circuits with consumer which in the event of a defect could produce smooth dc fault currents.

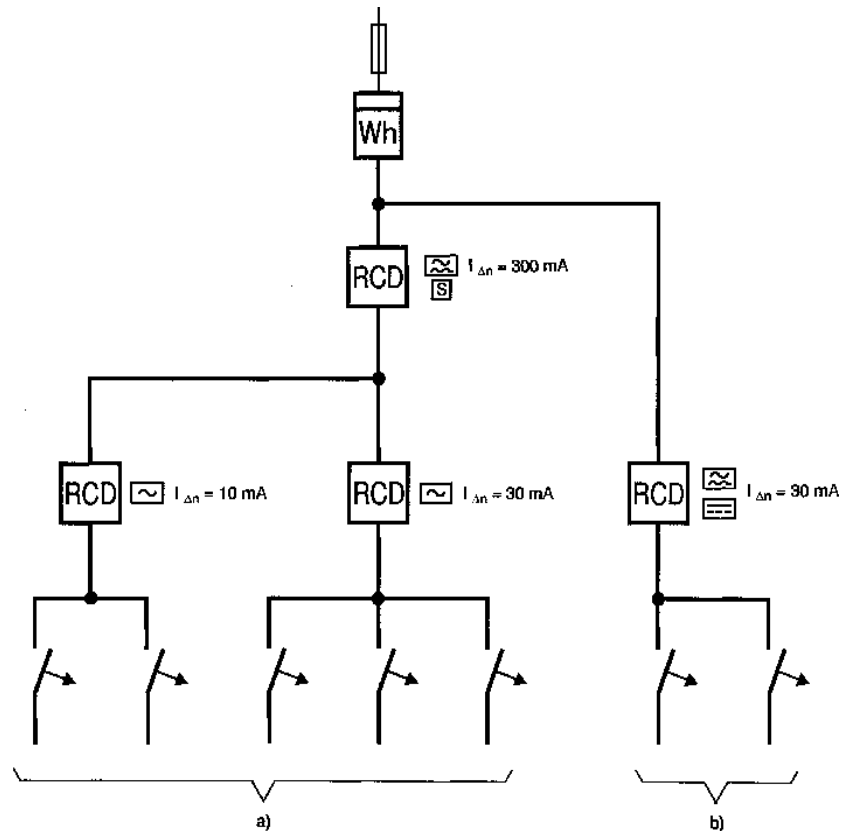

- a.) **With standard RCDs**  
Circuits with consumers, which produce in a case of a defect ac fault currents or/and pulsating dc fault currents.
- b.) **With universal current sensitive RCDs**  
Circuits with consumers, which produce in a case of a defect ac fault currents or/and pulsating dc fault currents or/and smooth dc fault currents.

SK 0069 Z96

# Residual Current-operated Circuit-Breakers F 804

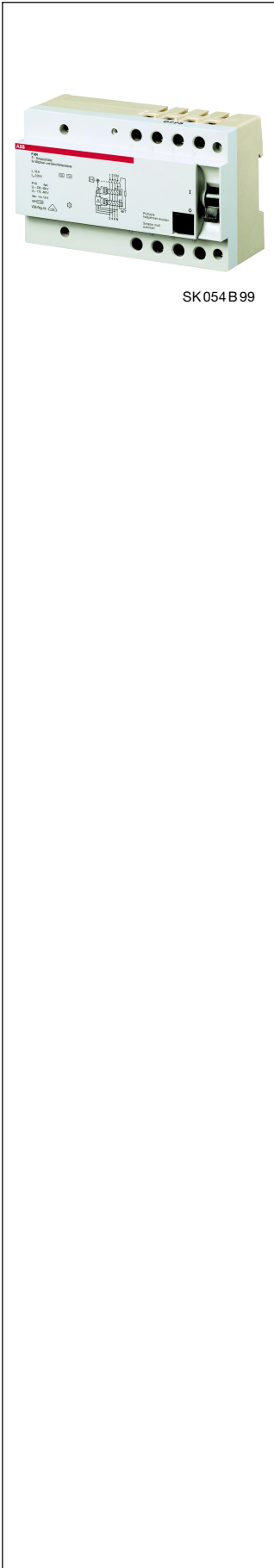

## Problem with standard RCDs

Defective frequency converters (FC) can affect upstream installed standard RCDs in such a way, that these standard RCDs are no longer able to trip when earth leakage currents arise.

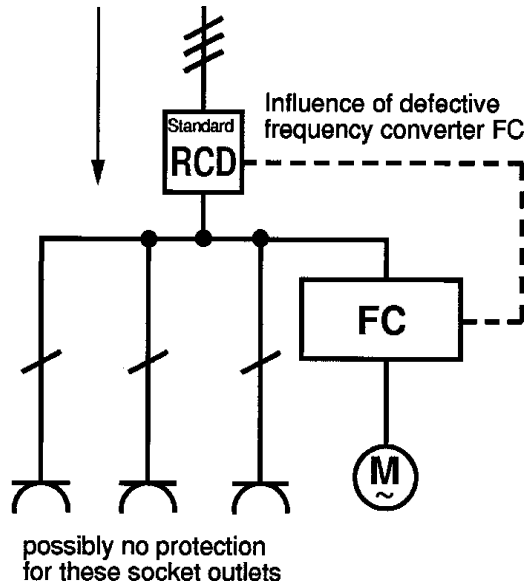

SK 0067 Z96

## Solution

STOTZ-Universal Current Sensitive RCD F 804 installed upstream of the frequency converter (FC).

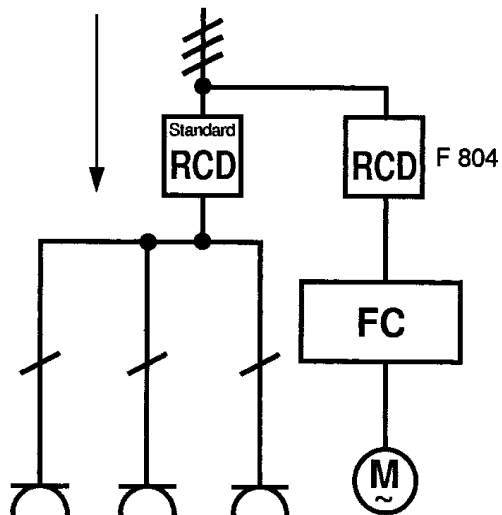

SK 0068 Z96

# Residual Current-operated Circuit-Breakers F 804

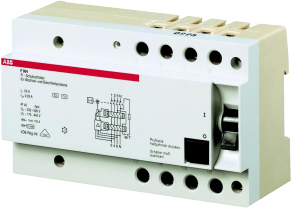

SK 054 B 99

Rated residual current $I_{\Delta n}$ mA	Rated current $I_n$ A	Ordering details		bbn <b>40 16779</b> EAN	Price 1 pc. DM	Weight 1 piece kg	Packing unit pcs.
		Type-No.	Order code				
30	63	<b>F 804-63/0.03</b>	GH F804 0001 R2590	<b>09320 0</b>		0.755	1
300	63	<b>F 804-63/0.3</b>	GH F804 0001 R4590	<b>09330 9</b>		0.683	1



---

**ABB STOTZ-KONTAKT GmbH**

P.O. Box 10 16 80, D-69006 Heidelberg  
Eppelheimer Straße 82, D-69123 Heidelberg  
Phone (0 62 21) 701 - 0  
Fax (0 62 21) 701 - 723