

TRIO-WIRL V

Vortex/Swirl Flowmeter
Model VT4000 / VR4000

TRIO-WIRL S

Vortex/Swirl Flowmeter
Model ST4000 / SR4000
Valid from Software Edition A10

Datalink Description
Foundation™ Fieldbus

D184B093U24 Rev. 01 / 03.2002

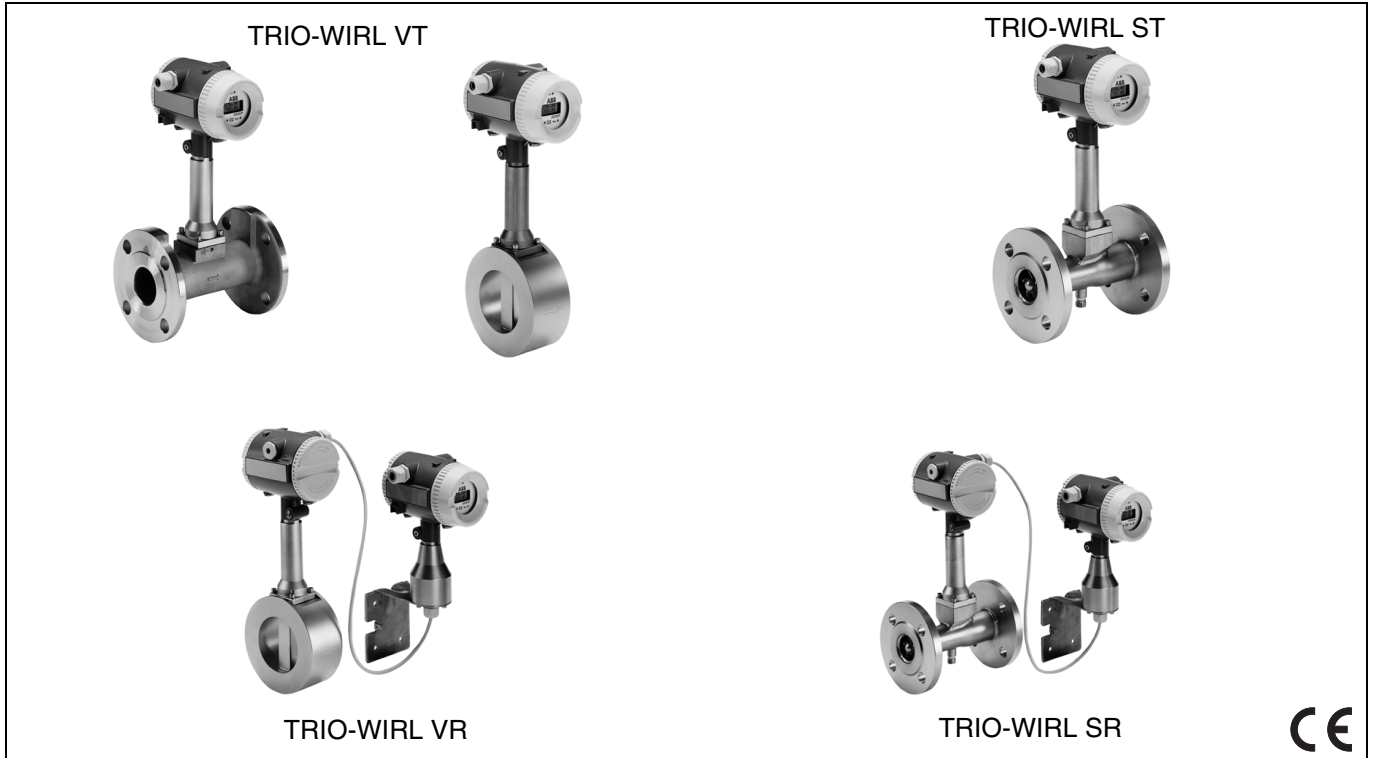

We congratulate you on having acquired a high-quality flowmeter designed by ABB Automation Products and thank you for the trust shown in our company.

The on-hand instruction bulletin contains instructions relating to installation and mounting as well as technical data regarding the respective instrument design. ABB Automation Products reserves the right of modifying, without prior notice, the instruments' Hard and Software for the benefit of technical progress. Should any questions crop up which are not covered by information given in this manual, please contact ABB Automation Products / Site Göttingen: Tel 05 51 / 9 05 – 0.

Copyright by ABB Automation Products. All rights reserved.

CONTENTS:

1.	BLOCK-OVERVIEW.....	4
1.1	BLOCK TABLE LEGEND	4
1.2	RESOURCE BLOCK.....	5
1.2.1	<i>Resource Block Parameter, sorted in accordance with index</i>	5
1.2.2	<i>Resource Block Parameter, sorted according to names</i>	8
1.3	ANALOG INPUT BLOCK	9
1.3.1	<i>Analog Input Block Diagram</i>	9
1.3.2	<i>Analogue Input Block Parameter, sorted according to index</i>	11
1.3.3	<i>Analogue Input Block Parameter, sorted according to names</i>	13
1.4	TRANSDUCER BLOCK	14
1.4.1	<i>Channels and Units</i>	15
1.4.2	<i>Transducer Block Parameter, sorted according to index</i>	16
1.4.3	<i>Transducer Block Parameter, sorted according to names</i>	28
1.5	DATA STRUCTURE.....	29
1.5.1	<i>DS-65 – Value & Status – Floating Point Structure</i>	29
1.5.2	<i>DS-68 – Scaling Structure</i>	29
1.5.3	<i>DS-69 – Mode Structure</i>	29
1.5.4	<i>DS-70 – Access Permissions</i>	29
1.5.5	<i>DS-71 – Alarm Float Structure</i>	29
1.5.6	<i>DS-72 – Alarm Discrete Structure</i>	29
1.5.7	<i>DS-73 – Event Update Structure</i>	29
1.5.8	<i>DS-74 – Alarm Summary Structure</i>	30
1.5.9	<i>DS-82 – Simulate – Floating Point Structure</i>	30
1.5.10	<i>DS-85 – Test Structure</i>	30
1.6	STATUS-BYTE	31
2.	HARDWARE SWITCH	32
3.	START-UP	33
3.1	NI-INTERFACE CONFIG	33
3.2	VERIFY HARDWARE SWITCH	34
3.3	CONNECTION ESTABLISHMENT	34
3.4	BLOCKS OUT OF SERVICE.....	35
3.5	INSTRUMENT AND BLOCK DENOMINATIONS	35
3.6	RESOURCE BLOCK.....	35
3.7	TRANSDUCER BLOCK	35
3.8	ANALOG INPUT BLOCK.....	36
3.8.1	<i>Unit with L_TYPE =Direct</i>	36
3.8.2	<i>Unit with L_TYPE=Indirect</i>	37
3.8.3	<i>Summary AI block settings</i>	38
3.9	PERIOD_OF_EXECUTION.....	40
3.10	SCHEDULING	41
3.11	DEVICE DISPLAY	42
3.11.1	<i>AI1 Out and AI2 Out</i>	42
3.11.2	<i>AI1 Status and AI2 Status</i>	42
3.12	ERROR DETECTION.....	42
3.12.1	<i>Write parameters</i>	42
3.12.2	<i>AI-Block cannot be set to auto</i>	44

1. Block-Overview

The TRIO-WIRL converter contains the following FF-Blocks:

- 1 x Resource Block
- 1 x Transducer Block
- 2 x Analog Input Block

The resource and analog input blocks are standard FF blocks. They entirely comply with the FF specification FF-891-1.4.

The transducer block is an enhanced block. The parameters up to the relevant index 29 correspond to the "Standard Flow with Calibration" block of the FF specification FF-903-3.0. The following parameters are instrument specific for TRIO-WIRL.

1.1 Block Table Legend

The below table treats the following attributes:

- Rel.Index: Relative index of parameter within a block.
- Data-Type: Data type of parameter. Some parameters are structures (DS-xx). These structures are specified in chapter 1.5.
- Size: Size of the parameter in Bytes.
- Storage Type:
- S = Static Parameter are stored permanently (non-volatile). When writing a static parameter the Static Revision Counter ST_REV of the respective block (Index 1 in each block) will be incremented by one.
 - N = Non-volatile parameters will be stored permanently. When writing „non-volatile parameters“ ST_REV remains unchanged.
 - D = Dynamic Parameter will be lost during powering off.
- Read: R = Parameter can be read.
- Write: Parameter can partially merely be written in certain operating modes (MODE_BLK, Index 5, sub parameter Target)
- OOS: Parameter can be written in Target-Mode „Out of Service“
 - Man: Parameter can be written in Target-Mode „Manual“.
 - Auto: Parameter can be written in Target-Mode „Auto“.
- Default Value: Basic setting of the parameters.
The parameter RESTART (Index 16 within Resource Block), selection „Restart with defaults“, allows resetting of the parameters to default values.

1.2 Resource Block

The resource block contains general information on the fieldbus instrument, such as manufacturer, instrument type, version no. etc.

1.2.1 Resource Block Parameter, sorted in accordance with index

Relative Index	Parameter Name	Data Type	Size	Storage Type	Read	Write in Target-Mode	Default Values	Description
1	ST_REV	Unsigned 16	2	S	R	-	0	Revision counter for the static parameters. The counter is incremented each time the static parameter is changed.
2	TAG_DESC	OctetString	32	S	R	OOS,Auto	space	The user description of the intended application of the block.
3	STRATEGY	Unsigned 16	2	S	R	OOS,Auto	0	This parameter can be used to create a grouping of blocks by relating the same reference number to each block of a group. This parameter is not checked or processed by the block.
4	ALERT_KEY	Unsigned 8	1	S	R	OOS,Auto	0	The identification number of the plant unit. This information may be used in the host for sorting alarms, etc.
5	MODE_BLK	DS-69	4	N,D,S,S	R	OOS,Auto	Target : OOS Actual : OOS Permitted: Auto, OOS Normal : Auto	The actual, target, permitted and normal operation modes of the block.
6	BLOCK_ERR	Bit String	2	D	R	-	0	This parameter contains a summary of the block alarms
7	RS_STATE	Unsigned 8	1	D	R	-	0	State of the function block state machine.
8	TEST_RW	DS-85	112	D	R	OOS,Auto	0	Read/write test parameter - used only for conformance testing.
9	DD_RESOURCE	OctetString	32	S	R	-		A description of the device description for the device
10	MANUFAC_ID	Unsigned 32	4	S	R	-	0x320 = ABB	Manufacturer identification number
11	DEV_TYPE	Unsigned 16	2	S	R	-	0x15 = TRIO-WIRL	Manufacturer's model name of the device
12	DEV_REV	Unsigned 8	1	S	R	-	1	Device revision
13	DD_REV	Unsigned 8	1	S	R	-	1	Revision of the DD file of the device
14	GRANT_DENY	DS-70	2	D	R	OOS,Auto	0	Options for the access from PLC and DCS systems to device parameters
15	HARD_TYPES	Bit String	2	S	R	-	0x8000	The types of hardware available for the channels of the device
16	RESTART	Unsigned 8	1	D	R	OOS,Auto	1	Several possibilities of restart are possible: 1) Run 2) Restart resource 3) Restart with defaults 4) Restart processor
17	FEATURES	Bit String	2	S	R	-	0x4800	Used to show resource block options. 0x4800 = Reports supported, Hard Write Lock supported
18	FEATURE_SEL	Bit String	2	S	R	OOS,Auto	0x4800	Used to select resource block options. 0x4800 = Reports supported, Hard Write Lock supported
19	CYCLE_TYPE	Bit String	2	S	R	-	0xC000	Describes the block execution methods. 0xC000 = Scheduled, Completion of block execution

Flowmeter TRIO-WIRL

Datalink Description Foundation Fieldbus

Relative Index	Parameter Name	Data Type	Size	Storage Type	Read	Write in Target-Mode	Default Values	Description
20	CYCLE_SEL	Bit String	2	S	R	OOS,Auto	0xC000	Select ion of the block execution method. 0xC000 = Scheduled, Completion of block execution
21	MIN_CYCLE_T	Unsigned 32	4	S	R	-	1600	Time duration of the shortest cycle time of the device in 1/32 ms
22	MEMORY_SIZE	Unsigned 16	2	S	R	-	0	Available memory in the device
23	NV_CYCLE_T	Unsigned 32	4	S	R	-	0	Interval between writing copies of NV parameters to non-volatile memory. Zero means never.
24	FREE_SPACE	Float	4	D	R	-	0.0	Percent of memory available for additional configuration.
25	FREE_TIME	Float	4	D	R	-	0.0	Percent of the block processing time that is free to process additional blocks.
26	SHED_RCAS	Unsigned 32	4	S	R	OOS,Auto	640000	Timeout time for connections to PLC or DCS in operation mode Rcas
27	SHED_ROUT	Unsigned 32	4	S	R	OOS,Auto	640000	Timeout time for connections to PLC or DCS in operation mod Rout
28	FAULT_STATE	Unsigned 8	1	N	R	-	1	Behaviour of output blocks if communication errors appears
29	SET_FSTATE	Unsigned 8	1	D	R	OOS,Auto	1	Allows the Fault State condition to be manually initiated
30	CLR_FSTATE	Unsigned 8	1	D	R	OOS,Auto	1	Allows deleting the fault state condition
31	MAX_NOTIFY	Unsigned 8	1	S	R	-	8	Maximum number of unconfirmed notify messages possible.
32	LIM_NOTIFY	Unsigned 8	1	S	R	OOS,Auto	8	Maximum number of unconfirmed notify messages allowed.
33	CONFIRM_TIME	Unsigned 32	4	S	R	OOS,Auto	640000	The time the device will wait for confirmation of receipt of a report before trying to send again. Retry shall not happen when CONFIRM_TIME = 0.
34	WRITE_LOCK	Unsigned 8	1	S	R	OOS,Auto	1	If set, no writing is allowed. Cannot be cleared by software. Note:this parameter is dependent from the hardware switch Write_Lock (see chapter 2)
35	UPDATE_EVT	DS-73	14	D	R	-	0;0;0;0;0;0;9;0	This message is generated by any change to static data.
36	BLOCK_ALM	DS-72	13	D	R	OOS,Auto	0;0;0;0;0;0;0;8;0;0	Indicates alarms which are related to the block
37	ALARM_SUM	DS-74	8	D,D,D,S	R	OOS,Auto	0;0;0;0	This parameter contains a summary of the block alarms
38	ACK_OPTION	Bit String	2	S	R	OOS,Auto	0	Defines if block alarms are automatically acknowledged or not
39	WRITE_PRI	Unsigned 8	1	S	R	OOS,Auto	0	Priority of the alarm generated by clearing the WRITE_LOCK.
40	WRITE_ALM	DS-72	13	D	R	OOS,Auto		This alert is generated if the write lock parameter is cleared.
41	ITK_VER	Unsigned 16	2	S	R	-	4	Version of the Interoperability Test Kit used to test the device.

1.2.2 Resource Block Parameter, sorted according to names

Parameter Name	Relative Index
ACK_OPTION	38
ALARM_SUM	37
ALERT_KEY	4
BLOCK_ALM	36
BLOCK_ERR	6
CLR_FSTATE	30
CONFIRM_TIME	33
CYCLE_SEL	20
CYCLE_TYPE	19
DD_RESOURCE	9
DD_REV	13
DEV_REV	12
DEV_TYPE	11
FAULT_STATE	28
FEATURE_SEL	18
FEATURES	17
FREE_SPACE	24
FREE_TIME	25
GRANT_DENY	14
HARD_TYPES	15
ITK_VER	41
LIM_NOTIFY	32
MANUFAC_ID	10
MAX_NOTIFY	31
MEMORY_SIZE	22
MIN_CYCLE_T	21
MODE_BLK	5
NV_CYCLE_T	23
RESTART	16
RS_STATE	7
SET_FSTATE	29
SHED_RCAS	26
SHED_ROUT	27
ST_REV	1
STRATEGY	3
TAG_DESC	2
TEST_RW	8
UPDATE_EVT	35
WRITE_ALM	40
WRITE_LOCK	34
WRITE_PRI	39

1.3 Analog Input Block

The measurement calculation takes place within the transducer block. The transducer block internally provides the measurement values via “Channels”. The cyclic output of the measurement values takes place via the analog input blocks (AI-block). The TRIO-WIRL converter disposes of two AI blocks.

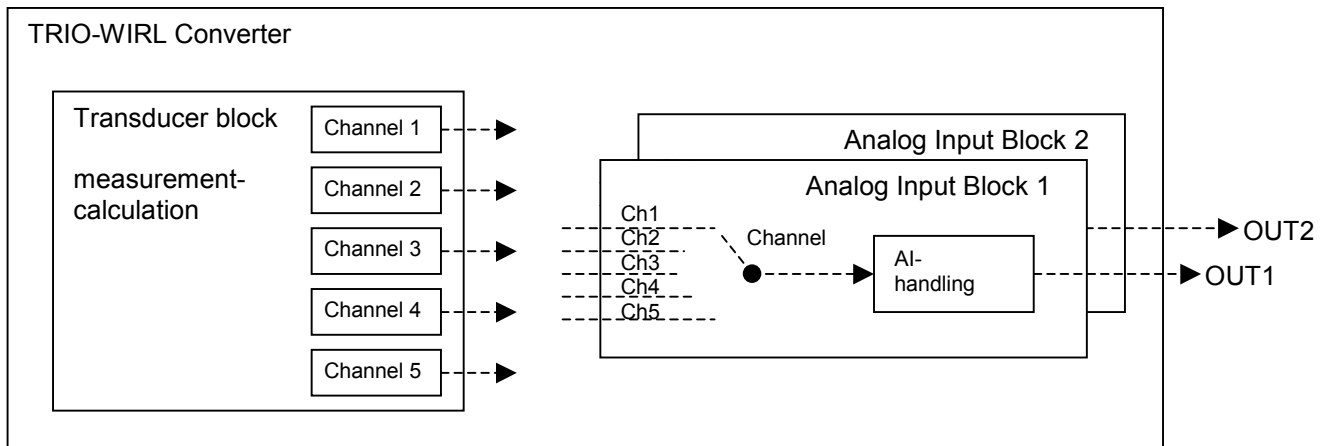

An AI block fulfils different tasks, such as change of scaling, alarm handling, simulation etc. See the following description:

1.3.1 Analog Input Block Diagram

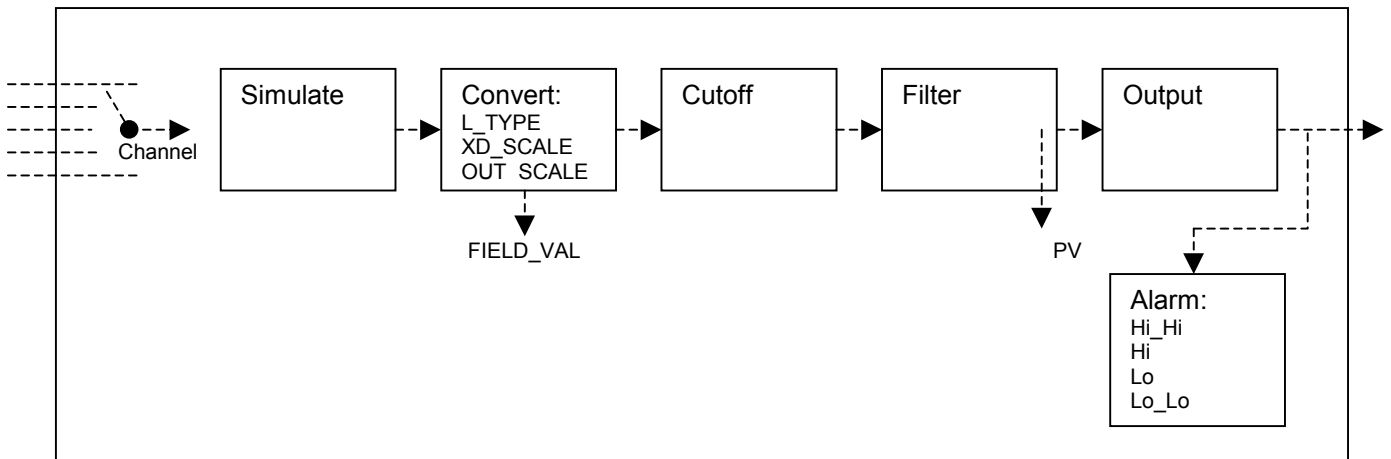

Channel: Using the channel parameter (index 15) you can choose the measured value to be transferred from the transducer block.

Simulate: The simulate parameter is a structure (see 1.5.9). You can activate a simulation by means of the sub-parameter “Simulate En/Disable”. The sub-parameter “Simulate-Value” indicates the simulation value which will be processed instead of the channel value.

Note: The simulation can solely be activated if the hardware switch “Simulation Enable” is set to “on”, see 2.

Convert: Converting is determined by the parameters L_TYPE, XD_SCALE and OUT_SCALE.
The scaling structures (see 1.5.2) dispose of the Sub-Parameters EU100%, EU0%, Unit and Decimal Point.

The channel value will be scaled to a percent value (FIELD_VAL) using the XD_SCALE according the following formula :

$$\text{FIELD_VAL} = 100 * (\text{Channel-Value} - \text{EU0\%}) / (\text{EU100\%}-\text{EU0\%})$$

L_TYPE can be of the following values:

Direct: With Direct the entry value will be directly transferred to PV (Primary Analog Value, index 7). There will be no change of scaling:

$$\text{PV} = \text{Channel Value}$$

Structures XD_SCALE and OUT_SCALE have to be adjusted identically.

Indirect: The percent value FIELD_VAL will be scaled to PV (Primary analog Value) using OUT_SCALE:

$$\text{PV} = (\text{FIELD_VAL} / 100) * (\text{EU100\%} - \text{EU0\%}) + \text{EU0\%}$$

Indirect Square Root: Similar to direct. Additionally a roots function will be calculated

$$\text{PV} = \text{sqrt}(\text{FIELD_VAL} / 100) * (\text{EU100\%} - \text{EU0\%}) + \text{EU0\%}$$

Cutoff: This function is equivalent to a low flow cut-off. It will be activated via a bit in IO_OPTS (index 13). If the PV value calculated undershoot the LOW_CUT value (index 17), PV will be set to 0.

Filter: Using the parameter PV_FTIME (index 18) you may set a damping time expressed in seconds.

Alarm: Four different alarms are available: Hi_Hi, Hi, Lo and Lo_Lo. For each of these alarms, the threshold ..._LIM and the priority ..._PRI can be set (index 25 to 32). A detected will be entered into a structure ..._ALM (index 33 to 36).

1.3.2 Analogue Input Block Parameter, sorted according to index

Relative Index	Parameter Name	Data Type	Size	Storage Type	Read	Write in Target-Mode	Default Values	Description
1	ST_REV	Unsigned 16	2	S	R	-	0	Revision counter for static variables. Every time a static variable changes the revision counter is incremented by one.
2	TAG_DESC	Octet String	32	S	R	OOS, Man,Auto	Leerzeichen	The user description of the application of the block.
3	STRATEGY	Unsigned 16	2	S	R	OOS, Man,Auto	0	This parameter can be used to create groups of blocks by assigning the same reference number to each block of a group. This parameter is not verified and not processed
4	ALERT_KEY	Unsigned 8	1	S	R	OOS, Man,Auto	0	This parameter is used as identification number for plant units. It can be used within DCS or PLC systems e.g. to sort alarms.
5	MODE_BLK	DS-69	4	N,D,S,S	R	OOS, Man,Auto	Target : OOS Actual : OOS Permitted: Auto, Man, OOS Normal : Auto	The actual, target, permitted, and normal operation modes of the block.
6	BLOCK_ERR	Bit String	2	D	R	-	0	Contains a summary of the block alarms
7	PV	DS-65	5	D	R	-	0.0	This parameter is the primary measurement value for use in executing the block.
8	OUT	DS-65	5	D	R	OOS, Man	0.0	This is the out value of the block. OUT will have standard block alarms plus standard HI_HI, HI, LO, and LO_LO alarms applied to it.
9	SIMULATE	DS-82	11	D	R	OOS, Man,Auto		This is a structure. With the sub parameter Simulate Enable/disable a simulation can be switched on and off. If a simulation is active the sub parameter simulate value is used as input value for the block.
10	XD_SCALE	DS-68	11	S	R	OOS, Man	EU100%: 100.0 EU0% : 0.0 Unit : 0 DecPoint: 0	Input scaling of the block. Using the 100% and 0% values the channel value is scaled to percent(Field_Val). The channel unit must be in accordance with the channel unit. DecPoint indicates the number of digits after the decimal point for the display.
11	OUT_SCALE	DS-68	11	S	R	OOS, Man	EU100%: 100.0 EU0% : 0.0 Unit : 0 DecPoint: 0	OUTPUT scaling of the block. Using the 100% and the 0% values the percent value (Field_Val) is scaled to the OUT value. The unit is the OUT unit. DecPoint indicates the number of digits after the decimal point for the display
12	GRANT_DENY	DS-70	2	D	R	OOS, Man,Auto	0;0	Options for the access of DCS and PLC systems to parameter of the device
13	IO_OPTS	Bit String	2	S	R	OOS	0	Options which the user may select to alter input and output block processing. Bit 10: Enable Low_Cutoff
14	STATUS_OPTS	Bit String	2	S	R	OOS	0	Options which the user may select in the block processing of its status.
15	CHANNEL	Unsigned 16	2	S	R	OOS	0	The number of the logical channel of the transducer block, which should be processed actually
16	L_TYPE	Unsigned 8	1	S	R	OOS, Man	0	Processing the input value: Direct: there is no scaling procedure the OUT is identical to the INPUT Indirect: the input value is scaled using XD_SCALE and OUT_SCALE Square root: like indirect, however a mathematical square root is added.
17	LOW_CUT	Float	4	S	R	OOS, Man,Auto	0.0	Low flow cutoff : Values lower than LOW_CUT are set to 0 if the option (see IO_OPTS)

Flowmeter TRIO-WIRL

Datalink Description Foundation Fieldbus

Relative Index	Parameter Name	Data Type	Size	Storage Type	Read	Write in Target-Mode	Default Values	Description
								is active
18	PV_FTIME	Float	4	S	R	OOS, Man,Auto	0.0	Time constant of a damping filter for process variable. Time constant is in seconds.
19	FIELD_VAL	DS-65	5	D	R	-	0x1C;0.0	Input value in percent scaled by XD_SCALE
20	UPDATE_EVT	DS-73	14	D	R	-		This alert is generated by any change to the static data.
21	BLOCK_ALM	DS-72	13	D	R	OOS, Man,Auto		Indicates the alarms related to the block
22	ALARM_SUM	DS-74	8	D	R	OOS, Man,Auto		This parameter contains a summary of the alarms of the block
23	ACK_OPTION	Bit String	2	S	R	OOS, Man,Auto	0	The selection of whether alarms associated with the block will be automatically acknowledged or not
24	ALARM_HYS	Float	4	S	R	OOS, Man,Auto	0.5	Alarm Hysteresis, expressed as a percent of the PV span .
25	HI_HI_PRI	Unsigned 8	1	S	R	OOS, Man,Auto	0	Priority of the high high alarm.
26	HI_HI_LIM	Float	4	S	R	OOS, Man,Auto	+INV	The value for the high high alarm limit in engineering units.
27	HI_PRI	Unsigned 8	1	S	R	OOS, Man,Auto	0	Priority of the high alarm.
28	HI_LIM	Float	4	S	R	OOS, Man,Auto	+INV	The value for the high alarm limit in engineering units.
29	LO_PRI	Unsigned 8	1	S	R	OOS, Man,Auto	0	Priority of the low alarm.
30	LO_LIM	Float	4	S	R	OOS, Man,Auto	-INV	The value for the low alarm limit in engineering units.
31	LO_LO_PRI	Unsigned 8	1	S	R	OOS, Man,Auto	0	Priority of the low low alarm.
32	LO_LO_LIM	Float	4	S	R	OOS, Man,Auto	-INV	The value for the low low alarm limit in engineering units.
33	HI_HI_ALM	DS-71	16	D	R	OOS, Man,Auto		The status for high high alarm and its associated time stamp.
34	HI_ALM	DS-71	16	D	R	OOS, Man,Auto		The status for high alarm and its associated time stamp.
35	LO_ALM	DS-71	16	D	R	OOS, Man,Auto		The status of the low alarm and its associated time stamp.
36	LO_LO_ALM	DS-71	16	D	R	OOS, Man,Auto		The status of the low low alarm and its associated time stamp.

1.3.3 Analogue Input Block Parameter, sorted according to names

Parameter Name	Relative Index
ACK_OPTION	23
ALARM_HYS	24
ALARM_SUM	22
ALERT_KEY	4
BLOCK_ALM	21
BLOCK_ERR	6
CHANNEL	15
FIELD_VAL	19
GRANT_DENY	12
HI_ALM	34
HI_HI_ALM	33
HI_HI_LIM	26
HI_HI_PRI	25
HI_LIM	28
HI_PRI	27
IO_OPTS	13
L_TYPE	16
LO_ALM	35
LO_LIM	30
LO_LO_ALM	36
LO_LO_LIM	32
LO_LO_PRI	31
LO_PRI	29
LOW_CUT	17
MODE_BLK	5
OUT	8
OUT_SCALE	11
PV	7
PV_FTIME	18
SIMULATE	9
ST_REV	1
STATUS_OPTS	14
STRATEGY	3
TAG_DESC	2
UPDATE_EVT	20
XD_SCALE	10

1.4 Transducer Block

The Transducer Block contains all instrument specific parameters and functions needed for flow measurement and calculation. The following diagram shows the sequence of calculations:

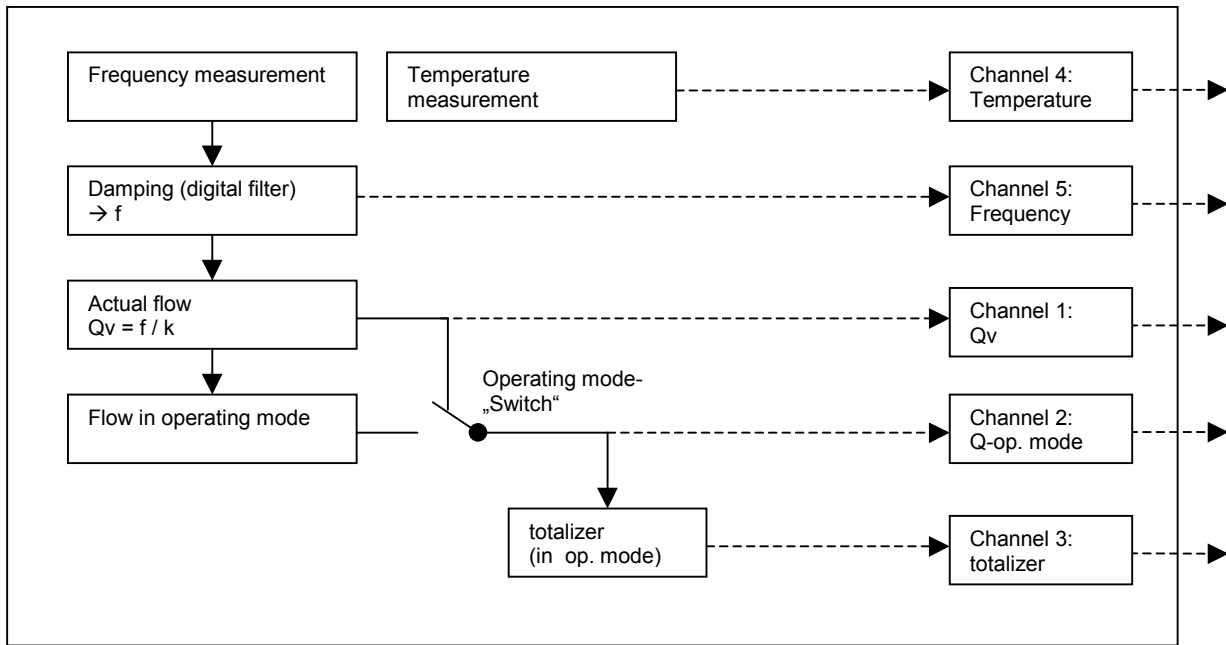

The Primary (Vortex or Swirl flow meter) generates a frequency signal. Using the calibration factors (k-factors) and damping parameter the converter calculates the actual flow value Q_v . In accordance to the operating mode a flow value is calculated (e.g. mass flow (Q_m), normal flow (Q_N)) and is the input for the flow totalizer. Additionally the temperature of the flow medium is measured, if this option is selected by ordering the device.

These calculated and measured values as is shown in the diagram can be taken from channel 1 to 5 from the transducer block output value.

Note: Cyclical readings of measured values can only be taken from the AI blocks. Using the channel parameter within the AI block the desired measurement value can be chosen. See picture in chapter 1.3.

1.4.1 Channels and Units

The transducer block within the TRIO-WIRL provides 5 measurements in so-called channels. Each AI block disposes of one channel parameter (index 15). This so-called channel parameter decides which channel will be transferred from the TB to the AI.

Each channel disposes of one physical unit. This unit has to comply with the XD-scale-unit of the AI blocks. Should it fail to do so, the AI block cannot be set to auto-mode.

Channel 1: Qv = actual flow

Unit: see TB-Parameter "Unit Qv" (Index 54)

Channel 2: Q Operating mode = flow in operating mode chosen

Unit: Depending on the respective operating mode (see TB index 42) this is a volume flow unit (see TB parameter "unit Qv" index 54) or a mass flow unit (see TB parameter "unit Qm" index 55)

Channel 3: Totalizer

Unit: depending on operating mode (see TB index 42) a volume flow unit (see TB parameter "unit Zv", index 61) or a mass flow unit (see TB parameter "unit Zm", index 62)

Channel 4: Temperature

Unit: see TB parameter "unit temp." (index 48)

Channel 5: Frequency

unit: Hz

1.4.2 Transducer Block Parameter, sorted according to index

Parameter:

- 1 to 29 equal a standard flow with calibration block, as described in FF document FF- 903 PS3.
 - 30 to 33 contain further measurement values; calculated within the transducer block
 - 34 to 125 comprise setting parameters of the converter. These are also accessible via display and keyboard of the converter.
- The description of the parameters can be taken from the converter instruction manual. In the following you can find a list of all entry values permitted.

Relative Index	Parameter Name	Data type	Size	Storage Type	Read	Write	Default Values	Description
1	ST_REV	Unsigned 16	2	S	R	-	1	Revision counter for statics variables. Each time a static variable is changed the counter is incremented by one.
2	TAG_DESC	OctetString	32	S	R	OOS,Auto	Space character	The user description of the intended application of the block.
3	STRATEGY	Unsigned 16	2	S	R	OOS,Auto	0	The strategy field can be used to create grouping of blocks by relating the same reference number to each block of a group. This data is not checked or processed by the block
4	ALERT_KEY	Unsigned 8	1	S	R	OOS,Auto	96	The identification number of the plant unit. This information may be used in PLC or DCS systems for sorting alarms, etc.
5	MODE_BLK	DS-69	4	N,D,S,S	R	OOS,Auto	Target : OOS Actual : OOS Permitted: Auto, OOS Normal : Auto	The actual, target, permitted, and normal modes of the block. Actual and allowable operation modes of the block.
6	BLOCK_ERR	Bit String	2	D	R	-	0	This parameter reflects the error status associated with the hardware or software components associated with a block. It is a bit string, so that multiple errors may be shown. Bit 0 = Other Bit 1 = Block Configuration Error Bit 2 = Link Configuration Error Bit 3 = Simulate Active Bit 4 = Local Override Bit 5 = Device Fail Safe Set Bit 6 = Device Needs Maintenance Soon Bit 7 = Input Failure/ process variable has BAD status Bit 8 = Output Failure Bit 9 = Memory Failure Bit 10 = Lost Static Data Bit 11 = Lost NV Data Bit 12 = Readback Check Failure Bit 13 = Device needs maintenance Now Bit 14 = Power-up Bit 15 = Out-of-Service (MSB)
7	UPDATE_EVT	DS-73	14	D	R	OOS,Auto		This alert is generated by any change to the static data.
8	BLOCK_ALM	DS-72	13	D	R	OOS,Auto		The block alarm is used for all configuration, hardware, connection failure or

Flowmeter TRIO-WIRL

Datalink Description Foundation Fieldbus

Relative Index	Parameter Name	Data type	Size	Storage Type	Read	Write	Default Values	Description
								system problems in the block.
9	TRANSDUCER_DIRECTORY	Array of Unsigned 16	1	C	R	-	0	The directory that specifies the number and starting indices of the transducers in the transducer block.
10	TRANSDUCER_TYPE	Unsigned 16	2	C	R	-		Identifies the transducer type that follows.
11	XD_ERROR	Unsigned 8	1	D	R	-		Error codes of the Block
12	COLLECTION_DIRECTORY	Array of Unsigned 32	1	C	R	-	0	A directory that specifies the number, starting indices, and DD Item IDs of the data collections in each transducer within a transducer block.
13	PRIMARY_VALUE_TYPE	Unsigned 16	2	S	R	OOS,Auto	101	The type of measurement represented by the primary value. The table shown below describes this parameter. 101 : volumetric flow
14	PRIMARY_VALUE	DS-65	5	D	R	-		The measured value is the actual flow QV Unit: see index 54, unit Qv
15	PRIMARY_VALUE_RANGE	DS-68	11	N	R	-		The High and Low range limit values, the engineering units code and the number of digits to the right of the decimal point to be used to display the Primary Value. High limit value = QmaxDN, see Index 56 Low Limit Value = 0 Unit = unit Qv, see index 54 DecPoint = 2
16	CAL_POINT_HI	Float	4	S	R	OOS,Auto		The highest calibration point: Equal to Index 56: QmaxDN Writing to this index means changing index 56 too
17	CAL_POINT_LO	Float	4	S	R	OOS,Auto		The lowest calibration point: Equal to Index 58: Qmin Writing to this index means changing index 58 too
18	CAL_MIN_SPAN	Float	4	C	R	-	0.0	The minimum calibration span value allowed. This value is not used and therefore is set to 0.0
19	CAL_UNIT	Unsigned 16	2	S	R	OOS,Auto	1349	The engineering units code index for the calibration values. Equal to Index 54: Einheit Qv Writing to this index means changing index 54 too
20	SENSOR_TYPE	Unsigned 16	2	C	R	OOS,Auto	112	The type of the sensor defined below. 112 : Vortex note: even if primary is SWIRL the number 112 is valid
21	SENSOR_RANGE	DS-68	11	C	R	-		The High and Low range measurement values, the engineering units code, and the number of digits to the right of the decimal point . SENSOR_RANGE.100%: QmaxDN, see Index 56 SENSOR_RANGE.0% : Qmin , see Index 58 SENSOR_RANGE.Unit : UnitQv , see Index 54 SENSOR_RANGE.DecPt: 2
22	SENSOR_SN	Visible String	32	C	R	-		The sensor serial number (not implemented for TRIO-WIRL)
23	SENSOR_CAL_METHOD	Unsigned 8	1	S	R	OOS,Auto		The method of sensor calibration
24	SENSOR_CAL_LOC	Visible String	32	S	R	OOS,Auto		The location of the last sensor calibration
25	SENSOR_CAL_DATE	Date	7	S	R	OOS,Auto		The date of the last sensor calibration.
26	SENSOR_CAL_WHO	Visible String	32	S	R	OOS,Auto		The name of the person who is responsible for the last sensor calibration.

Flowmeter TRIO-WIRL

Datalink Description Foundation Fieldbus

Relative Index	Parameter Name	Data type	Size	Storage Type	Read	Write	Default Values	Description
27	LIN-TYPE	Unsigned 16	2	C	R	OOS,Auto		Contains the linearisation type used to describe the behavior of the sensor: 1 : Linear with input signal
28	SECONDARY_VALUE	DS-65	5	D	R	-		Secondary Value = flow in operating mode chosen unit: see Index 54, UnitQv, or Index 55, Unit Qm, depending on operating mode chosen (Index 42)
29	SECONDARY_VALUE_UNIT	Unsigned 16	2	S	R	OOS,Auto		Unit: see Index 54, UnitQv, or Index 55, UnitQm, Depending on operating mode chosen (Index 42)
30	SECONDARY_VALUE_2	Float	4		R	-		Third Value = Temperature Unit: see Index 48, UnitTemp
31	SECONDARY_VALUE_2_UNIT	Unsigned 16	2		R	OOS,Auto		Unit: see Index 48, UnitTemp
32	SECONDARY_VALUE_3	Float	4		R	-		Fourth value = Frequency Unit: Hz
33	SECONDARY_VALUE_3_UNIT	Unsigned 16	2		R	OOS,Auto		Unit:: 1077 = Hz
34	Version	Visible String	16	N	R	-	D200F002U01 A.00	Software version
35	Progr.level	Unsigned 8	1	D	R	OOS,Auto	0	0 : Locked 1 : Standard 2 : Specialist 3 : Service
36	Service code	Unsigned 16	2	D	R	OOS,Auto		Limits: none Unit : none
37	language	Unsigned 8	1	S	R	OOS,Auto	0	0 : German 1 : English
38	Primary	Unsigned 8	1	S	R	OOS,Auto	1	0 : Swirl ST/SR 1 : Vortex VT/VR
39	Meter size Swirl	Unsigned 8	1	S	R	OOS,Auto	0	0 : 15 mm 1/2 in 1 : 20 mm 3/4 in 2 : 25 mm 1 in 3 : 32 mm 1-1/4 in 4 : 40 mm 1-1/2 in 5 : 50 mm 2 in 6 : 80 mm 3 in 7 : 100 mm 4 in 8 : 150 mm 6 in 9 : 200 mm 8 in 10: 300 mm 12 in 11: 400 mm 16 in
40	Meter size Vortex	Unsigned 8	1	S	R	OOS,Auto	0	0 : DIN 15mm 0.5in 1 : DIN 25mm 1in 2 : DIN 40mm 1.5in 3 : DIN 50mm 2in 4 : DIN 80mm 3in 5 : DIN 100mm 4in 6 : DIN 150mm 6in 7 : DIN 200mm 8in

Flowmeter TRIO-WIRL

Datalink Description Foundation Fieldbus

Relative Index	Parameter Name	Data type	Size	Storage Type	Read	Write	Default Values	Description
								8 : DIN 250mm 10in 9 : DIN 300mm 12in 10: ANSI 15mm 0.5in 11 : ANSI 25mm 1in 12 : ANSI 40mm 1.5in 13 : ANSI 50mm 2in 14 : ANSI 80mm 3in 15 : ANSI 100mm 4in 16 : ANSI 150mm 6in 17 : ANSI 200mm 8in 18 : ANSI 250mm 10in 19 : ANSI 300mm 12in
41	Shedule Correct.	Unsigned 8	1	S	R	OOS,Auto	1	0 : Schedule40 1 : Schedule80
42	Flow mode	Unsigned 8	1	S	R	OOS,Auto	0	0 : Liquid Qv (1) 1 : Liquid Qm (D) (1) 2 : Liquid Qm (D,T) (2) 3 : Liquid Qm (V,T) (2) 4 : Gas Qv (3) 5 : Gas Norm Qn (pT) (4) 6 : Gas Stnd Qs (pT) (4) 7 : Gas Stnd Qs (Cmp) (3) 8 : Gas MassQm (pT) (4) 9 : Gas MassQm (D) (3) 10: Steam satu. Qm (4) 11: Steam satu. Qv (4) Notes: (1) can solely be chosen if "Enable K-Set" (Index 83) is set to 1 or 2 (2) can solely be chosen if "Enable K-Set" (Index 83) is set to 1 or 2 and PT100-Sensor (Index 82) is set to 1 (3) can solely be chosen if "Enable K-Set" (Index 83) is set to 0 or 2 (4) can solely be chosen if "Enable K-Set" (Index 83) is set to 0 or 2 and PT100-Sensor (Index 82) be set to 1
43	Unit Density	Unsigned 16	2	S	R	OOS,Auto	1103	1104: g/ml 1100: g/cm3 1105: g/l 1103: kg/l 1097: kg/m3 1107: lb/ft3 1108: lb/ugl
44	Reference density	Float	4	S	R	OOS,Auto	1.0	Lower limit: 0.00001 kg/l Upper limit :10 kg/l or corresponding values expressed in different units Unit : see Index 43, Unit density

Flowmeter TRIO-WIRL

Datalink Description Foundation Fieldbus

Relative Index	Parameter Name	Data type	Size	Storage Type	Read	Write	Default Values	Description
45	Normal density	Float	4	S	R	OOS,Auto	0.001293	Lower limit: 0.0 kg/l Upper limit :0.1 kg/l Or corresponding values expressed in different units Unit : see Index 43, Unit density
46	Norm factor	Float	4	S	R	OOS,Auto	1.0	Lower limit: 0.00001 Upper limit : 30.0 Unit : none
47	Normal condition	Unsigned 8	1	S	R	OOS,Auto	0	0 : 1.0133bara °C 1 : 1.0133bara 20 °C 2 : 14.7psi-abs 60F 3 : 14.7psi-abs 70F
48	Unit temperature	Unsigned 16	2	S	R	OOS,Auto	1001	1001: °C 1002: F 1000: K
49	Reference temperature	Float	4	S	R	OOS,Auto	20.0	Lower limit: -200 °C Upper limit : 450 °C Or corresponding values expressed in different units Unit : see Index 48, UnitTemp.
50	Unit pressure	Unsigned 16	2	S	R	OOS,Auto	1137	1137: bara 1142: PSIA 1132: MPA 1138: mbar
51	PressurePopr abs	Float	4	S	R	OOS,Auto	1.0133	Lower limit: 0 bar Upper limit : 100 bar Or corresponding values expressed in different units Unit : see Index 50, Unit Pressure
52	Volume Extension	Float	4	S	R	OOS,Auto	1.0	Lower limit: 0 Upper limit : 10.0 Unit : none
53	Density Extension	Float	4	S	R	OOS,Auto	1.0	Lower limit: 0 Upper limit : 10.0 Unit : none
54	Unit Qvol	Unsigned 16	2	S	R	OOS,Auto	1349	1351: l/s 1352: l/m 1353: l/h 1347: m3/s 1348: m3/m 1349: m3/h 1350: m3/d 1356: ft3/s 1357: ft3/m 1358: ft3/h 1359: ft3/d 1362: usgps 1363: usgpm

Flowmeter TRIO-WIRL

Datalink Description Foundation Fieldbus

Relative Index	Parameter Name	Data type	Size	Storage Type	Read	Write	Default Values	Description
								1364: usgph 1365: usmgd 1367: igps 1368: igpm 1369: igph 1370: igpd 1371: bbl/s 1372: bbl/m 1373: bbl/h 1374: bbl/d
55	Unit Qm	Unsigned 16	2	S	R	OOS,Auto	1324	1318: g/s 1319: g/m 1320: g/h 1322: kg/s 1323: kg/m 1324: kg/h 1325: kg/d 1327: t/m 1328: t/h 1329: t/d 1330: lb/s 1331: lb/m 1332: lb/h 1333: lb/d
56	QmaxDN operation	Float	4	N	R	-	1.67	Unit: see Index 54, UnitQv
57	Qmax	Float	4	S	R	OOS,Auto	1.67	Limits: depending on different other parameters Unit : see index 54, unitQv or index 55, unitQm, depending on operating mode chosen (index 42)
58	Qmin operat.	Float	4	S	R	OOS,Auto	0.139	Lower limit: 0 Upper limit : depending on other parameters Unit: see index 54, UnitQv
59	Totalizer	Float	4	N	R	-	0.0	Unit: see index 61, unitZv, or Index 62, unitZm, Depending on operating mode chosen (Index 42)
60	Overflow (totalizer)	Unsigned 16	2	N	R	-	0	Unit: none
61	Unit totalizer (Volume units)	Unsigned 16	2	S	R	OOS,Auto	1034	1038: l 1034: m3 1043: ft3 1048: ugl 1049: igl 1051: bbl
62	Unit totalizer (Mass unit)	Unsigned 16	2	S	R	OOS,Auto	1088	1089: g 1088: kg 1092: t 1094: lb
63	Totalizer Reset		1	D	R	OOS,Auto	0	0 : no totalizer reset

Flowmeter TRIO-WIRL

Datalink Description Foundation Fieldbus

Relative Index	Parameter Name	Data type	Size	Storage Type	Read	Write	Default Values	Description
								1 : reset totalizer Note: value will be automatically reset to 0 should a value other than zero be entered.
64	Damping	Float	4	S	R	OOS,Auto	3.0	Lower limit : 0.2 Upper limit : 100 Unit : Seconds
65	Hardware Config.	Unsigned 8	1	S	R	OOS,Auto	0	0 : Off 1 : Puls_Bin 2 : Q_Alarm 3 : T_Alarm (1) 4 : S_Alarm Note: (1) can solely be chosen, should the parameter PT100Sensor (Index 82) be set to 1
66	Minalarm flow	Float	4	S	R	OOS,Auto	0.0	Lower limit : 0 Upper limit : 100 unit : %
67	Maxalarm flow	Float	4	S	R	OOS,Auto	100.0	Lower limit : 0 Upper limit : 100 Unit : %
68	Minalarm Temp.	Float	4	S	R	OOS,Auto	-60.0	Lower limit : -60.0 °C Upper limit : 510.0 °C Or corresponding values expressed in different units Unit : see Index 48, UnitTemp
69	Maxalarm Temp.	Float	4	S	R	OOS,Auto	510.0	Lower limit : -60.0 °C Upper limit : 510.0 °C Or corresponding values expressed in different units Unit : see Index 48, UnitTemp
70	Pulse factor	Float	4	S	R	OOS,Auto	20.0	Lower limit : 0.001 Upper limit : 1000 Note: in some cases the input range may be less Unit : 1 / Unit Totalizer
71	Pulse width	Float	4	S	R	OOS,Auto	5	Lower limit : 1 msec Upper limit : 256 msec or less. (limitation to max. 50% period length at pulse output) Unit : msec
72	Display mode	Unsigned 8	1	S	R	OOS,Auto	0	0 : 1 big line, 1 small line 1 : 4 small lines
73	Display line 1	Unsigned 8	1	S	R	OOS,Auto	0	0 : Q Operating mode
74	Display line 2	Unsigned 8	1	S	R	OOS,Auto	3	1 : Qv Operation
75	Display line 3	Unsigned 8	1	S	R	OOS,Auto	2	2 : Per cent 3 : Totalizer 4 : Temperature (1) 5 : Frequency 6 : AI1 Out
22								7 : AI1 Status 8 : AI2 Out 9 : AI2 Status Note: (1) can solely be chosen, should the parameter PT100Sensor (Index 82) be set to 1

Flowmeter TRIO-WIRL

Datalink Description Foundation Fieldbus

Relative Index	Parameter Name	Data type	Size	Storage Type	Read	Write	Default Values	Description
76	Display line 4	Unsigned 8	1	S	R	OOS,Auto	5	
77	Display contrast	Unsigned 8	1	S	R	-	144	Range 136 (min. Contrast) – 159 (max. Contrast)
78	Error register	Unsigned 16	2	N	R	-	0	Bit 0: Steam calculation Bit 1: Front end Bit 2: - Bit 3: Flow > 115% Bit 4: - Bit 5: Main Data base Bit 6: Totalizer incorrect Bit 7: Temperature Bit 8: - Bit 9: Qv > 115% QmaxDN Bit 10: - Bit 11: Backup Data base Bit 12: - Bit 13: - Bit 14: - Bit 15: -
79	Mains failure	Unsigned 16	2	N	R	-	0	
80	Instrument No.	Unsigned 16	2	N	R	-	0	
81	Order-Number	Visible String	16	S	R	OOS,Auto	00000000x000	
82	PT100 Sensor	Unsigned 8	1	S	R	OOS,Auto	0	0 : Off 1 : On
83	Enable K-Set	Unsigned 8	1	S	R	OOS,Auto	2	0 : Gas 1 : Liquid 2 : Liquid & Gas
84	k-Linearisation	Unsigned 8	1	S	R	OOS,Auto	0	0 : mean value 1 : 5 points
85	Schedule-ShiftFct	Float	4	S	R	OOS,Auto	0.0	Lower limit : -10.0 Upper limit : 10.0 Unit : none
86	Calib.Schedule	Float	4	S	R	OOS,Auto	1.0	0 : Schedule40 1 : Schedule80
87	Liquid f1	Float	4	S	R	OOS,Auto	2500.0	Lower limit : 1 Upper limit : Liquid f2 Unit : Hz
88	Liquid f2	Float	4	S	R	OOS,Auto	2500.0	Lower limit : Liquid f1 Upper limit : Liquid f3 Unit : Hz
89	Liquid f3	Float	4	S	R	OOS,Auto	2500.0	Lower limit : Liquid f2 Upper limit : Liquid f4 Unit : Hz
90	Liquid f4	Float	4	S	R	OOS,Auto	2500.0	Lower limit : Liquid f3 Upper limit : Liquid f5

Flowmeter TRIO-WIRL
Datalink Description Foundation Fieldbus

Relative Index	Parameter Name	Data type	Size	Storage Type	Read	Write	Default Values	Description
91	Liquid f5	Float	4	S	R	OOS,Auto	2500.0	Unit : Hz Lower limit : Liquid f4 Upper limit : 2500 Unit : Hz
92	Liquid k1	Float	4	S	R	OOS,Auto	60.0	Lower limit : 1.0 Upper limit : 200000.0 Unit : 1/m3
93	Liquid k2	Float	4	S	R	OOS,Auto	60.0	Lower limit : 1.0 Upper limit : 200000.0 Unit : 1/m3
94	Liquid k3	Float	4	S	R	OOS,Auto	60.0	Lower limit : 1.0 Upper limit : 200000.0 Unit : 1/m3
95	Liquid k4	Float	4	S	R	OOS,Auto	60.0	Lower limit : 1.0 Upper limit : 200000.0 Unit : 1/m3
96	Liquid k5	Float	4	S	R	OOS,Auto	60.0	Lower limit : 1.0 Upper limit : 200000.0 Unit : 1/m3
97	Liquid km	Float	4	S	R	OOS,Auto	60.0	Lower limit : 1.0 Upper limit : 200000.0 Unit : 1/m3
98	Gas f1	Float	4	S	R	OOS,Auto	2500.0	Lower limit : 1 Upper limit : Gas f2 Unit : Hz
99	Gas f2	Float	4	S	R	OOS,Auto	2500.0	Lower limit : Gas f1 Upper limit : Gas f3 Unit : Hz
100	Gas f3	Float	4	S	R	OOS,Auto	2500.0	Lower limit : Gas f2 Upper limit : Gas f4 Unit : Hz
101	Gas f4	Float	4	S	R	OOS,Auto	2500.0	Lower limit : Gas f3 Upper limit : Gas f5 Unit : Hz
102	Gas f5	Float	4	S	R	OOS,Auto	2500.0	Lower limit : Gas f4 Upper limit : 2500 Unit : Hz
103	Gas k1	Float	4	S	R	OOS,Auto	150.0	Lower limit : 1.0 Upper limit : 200000.0 Unit : 1/m3
104	Gas k2	Float	4	S	R	OOS,Auto	150.0	Lower limit : 1.0 Upper limit : 200000.0 Unit : 1/m3
105	Gas k3	Float	4	S	R	OOS,Auto	150.0	Lower limit : 1.0

Flowmeter TRIO-WIRL
Datalink Description Foundation Fieldbus

Relative Index	Parameter Name	Data type	Size	Storage Type	Read	Write	Default Values	Description
								Upper limit : 200000.0 Unit : 1/m3
106	Gas k4	Float	4	S	R	OOS,Auto	150.0	Lower limit : 1.0 Upper limit : 200000.0 Unit : 1/m3
107	Gas k5	Float	4	S	R	OOS,Auto	150.0	Lower limit : 1.0 Upper limit : 200000.0 Unit : 1/m3
108	Gas km	Float	4	S	R	OOS,Auto	150.0	Lower limit : 1.0 Upper limit : 200000.0 Unit : 1/m3
109	DSP BootPage	Unsigned 8	1	S	R	OOS,Auto	1	0 : Page 0 1 : Page Standard 2 : Page Spectrum
110	Freq.Min	Unsigned 8	1	S	R	OOS,Auto	6	0 : 954Hz 1 : 477Hz 2 : 238Hz 3 : 119Hz 4 : 60Hz 5 : 30Hz 6 : 15Hz 7 : 8Hz 8 : 4Hz 9 : 2Hz 10: 1Hz
111	Freq.Max	Unsigned 8	1	S	R	OOS,Auto	1	0 : 2500Hz 1 : 954Hz 2 : 477Hz 3 : 238Hz 4 : 119Hz 5 : 60Hz 6 : 30Hz 7 : 15Hz 8 : 8Hz 9 : 4Hz 10 : 2Hz
112	Gain Max	Unsigned 16	2	S	R	OOS,Auto	0x06EA	Lower limit : 0x400 Upper limit : 0x07FF Unit : none
113	BP-Aver Damp	Unsigned 8	1	S	R	OOS,Auto	1	0 : 1.0 Sec 1 : 2.0 Sec 2 : 5.0 Sec
114	FreqSpecBalance	Unsigned 8	1	S	R	OOS,Auto	0	0 : Off 1 : 1 2 : 2

Flowmeter TRIO-WIRL
Datalink Description Foundation Fieldbus

Relative Index	Parameter Name	Data type	Size	Storage Type	Read	Write	Default Values	Description
								3 : 3
115	Input Minimum	Float	4	S	R	OOS,Auto	0.03	Lower limit : 0 Upper limit : 0.99 Unit : none
116	Gain VibTrigger	Unsigned 16	2	S	R	OOS,Auto	0x062C	Lower limit : 0x400 Upper limit : 0x07FF Unit : none
117	Vib Qv Factor	Float	4	S	R	OOS,Auto	0.9	Lower limit : 0 Upper limit : 0.99 Unit : none
118	Input Select	Unsigned 8	1	S	R	OOS,Auto	0	0 : Qv 1 : Qv Comp
119	Low DisFrequen.	Float	4	S	R	OOS,Auto	5000	Lower limit : 0 Upper limit : 5000 Unit : none
120	High DisFrequen.	Float	4	S	R	OOS,Auto	5000	Lower limit : 0 Upper limit : 5000 Unit : none
121	Low DisGain	Unsigned 16	2	S	R	OOS,Auto	0x07FF	Lower limit : 0x0400 Upper limit : 0x07FF Unit : none
122	High DisGain	Unsigned 16	2	S	R	OOS,Auto	0x07FF	Lower limit : 0x0400 Upper limit : 0x07FF Unit : none
123	Temp.Correct.	Float	4	S	R	OOS,Auto	0.0	Lower limit : -10.0 Upper limit : 10.0 Unit : Celsius
124	Temp.Interval	Unsigned 16	2	S	R	OOS,Auto	32767	Lower limit : 0 Upper limit : 32767 Unit : none
125	Service Display	Unsigned 8	1	D	R	OOS,Auto	0	0 : BP Range 1 : BP State 2 : Input Values 3 : Vib In Values 4 : Input Quality 5 : Gain Values 6 : Freq Values

1.4.3 Transducer Block Parameter, sorted according to names

Parameter Name	Index
ALERT_KEY	4
BLOCK_ALM	8
BLOCK_ERR	6
BP-Aver Damp	113
CAL_MIN_SPAN	18
CAL_POINT_HI	16
CAL_POINT_LO	17
CAL_UNIT	19
Calib.Schedule	86
COLLECTION_DIRECTORY	12
Compressibility	46
Damping	64
Density Extension	53
Display contrast	77
Display line 1	73
Display line 2	74
Display line 3	75
Display line 4	76
Display mode	72
DSP BootPage	109
Enable K-Set	83
Error register	78
Flow mode	42
Freq.Max	111
Freq.Min	110
FreqSpecBalance	114
Gain Max	112
Gain VibTrigger	116
Gas f1	98
Gas f2	99
Gas f3	100
Gas f4	101
Gas f5	102
Gas k1	103
Gas k2	104
Gas k3	105
Gas k4	106
Gas k5	107
Gas km	108
Hardware Config.	65
High DisFrequen.	120
High DisGain	122
Input Minimum	115
Input Select	118
Instrument No.	80
k-Linearisation	84
language	37
LIN-TYPE	27
Liquid f1	87
Liquid f2	88
Liquid f3	89
Liquid f4	90
Liquid f5	91
Liquid k1	92
Liquid k2	93
Liquid k3	94
Liquid k4	95
Liquid k5	96
Liquid km	97
Low DisFrequen.	119
Low DisGain	121
Mains failure	79
Maxalarm flow	67
Maxalarm Temp.	69
Meter size Swirl	39

Parameter Name	Index
Meter size Vortex	40
Minalarm flow	66
Minalarm Temp.	68
MODE_BLK	5
Normal condition	47
Normal density	45
Order-Number	81
Overflow (totalizer)	60
PressurePopr abs	51
Primary	38
PRIMARY_VALUE	14
PRIMARY_VALUE_RANGE	15
PRIMARY_VALUE_TYPE	13
Progr.level	35
PT100 Sensor	82
Pulse factor	70
Pulse width	71
Qmax	57
QmaxDN operat.	56
Qmin operat.	58
Reference density	44
Reference temp.	49
SECONDARY_VALUE	28
SECONDARY_VALUE_2	30
SECONDARY_VALUE_2_UNIT	31
SECONDARY_VALUE_3	32
SECONDARY_VALUE_3_UNIT	33
SECONDARY_VALUE_UNIT	29
SENSOR_CAL_DATE	25
SENSOR_CAL_LOC	24
SENSOR_CAL_METHOD	23
SENSOR_CAL_WHO	26
SENSOR_RANGE	21
SENSOR_SN	22
SENSOR_TYPE	20
Service code	36
Service Display	125
Shedule Correct.	41
Shedule-ShiftFct	85
ST_REV	1
STRATEGY	3
TAG_DESC	2
Temp.Correct.	123
Temp.Interval	124
Totalizer	59
Totalizer Reset	63
TRANSDUCER_DIRECTORY	9
TRANSDUCER_TYPE	10
Unit Density	43
Unit pressure	50
Unit Qm	55
Unit Qvol	54
Unit Temp.	48
Unit totalizer	61
Unit totalizer	62
UPDATE_EVT	7
Version	34
Vib Qv Factor	117
Volume Extension	52
XD_ERROR	11

1.5 Data Structure

1.5.1 DS-65 – Value & Status – Floating Point Structure

E	Element Name	Data Type	Size
1	Status	Unsigned8	1
2	Value	Float	4

1.5.2 DS-68 – Scaling Structure

E	Element Name	Data Type	Size
1	EU at 100%	Float	4
2	EU at 0%	Float	4
3	Units Index	Unsigned16	2
4	Decimal Point	Integer8	1

1.5.3 DS-69 – Mode Structure

E	Element Name	Data Type	Size
1	Target	Bitstring	1
2	Actual	Bitstring	1
3	Permitted	Bitstring	1
4	Normal	Bitstring	1

1.5.4 DS-70 – Access Permissions

E	Element Name	Data Type	Size
1	Grant	Bitstring	1
2	Deny	Bitstring	1

1.5.5 DS-71 – Alarm Float Structure

E	Element Name	Data Type	Size
1	Unacknowledged	Unsigned8	1
2	Alarm State	Unsigned8	1
3	Time Stamp	Time Value	8
4	Subcode	Unsigned16	2
5	Value	Float	4

1.5.6 DS-72 – Alarm Discrete Structure

E	Element Name	Data Type	Size
1	Unacknowledged	Unsigned8	1
2	Alarm State	Unsigned8	1
3	Time Stamp	Time Value	8
4	Subcode	Unsigned16	2
5	Value	Unsigned8	1

1.5.7 DS-73 – Event Update Structure

E	Element Name	Data Type	Size
1	Unacknowledged	Unsigned8	1
2	Update State	Unsigned8	1
3	Time Stamp	Time Value	8
4	Static Revision	Unsigned16	2
5	Relative Index	Unsigned16	2

1.5.8 DS-74 – Alarm Summary Structure

E	Element Name	Data Type	Size
1	Current	Bitstring	2
2	Unacknowledged	Bitstring	2
3	Unreported	Bitstring	2
4	Disabled	Bitstring	2

1.5.9 DS-82 – Simulate – Floating Point Structure

E	Element Name	Data Type	Size
1	Simulate Status	Unsigned8	1
2	Simulate Value	Float	4
3	Transducer Status	Unsigned8	1
4	Transducer Value	Float	4
5	Simulate En/Disable	Unsigned8	1

1.5.10 DS-85 – Test Structure

E	Element Name	Data Type	Size
1	Value 1	Boolean	1
2	Value 2	Integer8	1
3	Value 3	Integer16	2
4	Value 4	Integer32	4
5	Value 5	Unsigned8	1
6	Value 6	Unsigned16	2
7	Value 7	Unsigned32	4
8	Value 8	Float	4
9	Value 9	Visible String	32
10	Value 10	Octet String	32
11	Value 11	Date	7
12	Value 12	Time of Day	6
13	Value 13	Time Difference	6
14	Value 14	Bitstring	2
15	Value 15	Time Value	8

1.6 Status-Byte

Measurement values are usually transferred as data structure DS-65 – Value & Status in cyclic communication. This structure consists of a value as float number and a status information as byte. This status byte has the following 3 parts:

Bit 7	Bit 6	Bit 5	Bit 4	Bit 3	Bit 2	Bit 1	Bit 0
Quality		Quality Substatus				Limits	

Quality

- 0: Bad
- 1: Uncertain
- 2: Good (Not Cascade)
- 3: Good (Cascade)

Substatus BAD

- 0: Non-specific
- 1: Configuration Error
- 2: Not Connected
- 3: Device Failure
- 4: Sensor Failure
- 5: No Communication (last usable value)
- 6: No Communication (no usable value)
- 7: Out of Service

Substatus UNCERTAIN

- 0: Non-specific
- 1: Last Usable Value
- 2: Substitute
- 3: Initial Value
- 4: Sensor Conversion not Accurate
- 5: Engineering Unit Range Violation
- 6: Sub-normal

Substatus GOOD (Non-Cascade)

- 0: Non-specific
- 1: Active Block Alarm
- 2: Active Advisory Alarm (priority < 8)
- 3: Active Critical Alarm (priority > 8)
- 4: Unacknowledged Block Alarm
- 5: Unacknowledged Advisory Alarm
- 6: Unacknowledged Critical Alarm

Substatus GOOD (Cascade)

- 0: Non-specific
- 1: Initialisation Acknowledge
- 2: Initialisation Request
- 3: Not Invited
- 4: Not Selected
- 5: Local Override
- 6: -
- 7: Fault State Active
- 8: Initiate Fault State

Limits:

- 0: Not limited
- 1: Low limited
- 2: High limited
- 3: Constant

2. Hardware Switch

The switches can be found on the digital board (below the display). Should you desire to reach the switch, please unscrew the housing lid. The switch setting can be read out on the device display using the submenu function test, menu DIP-Switch.

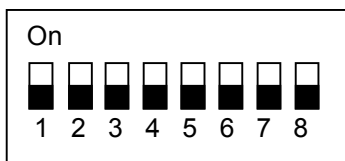
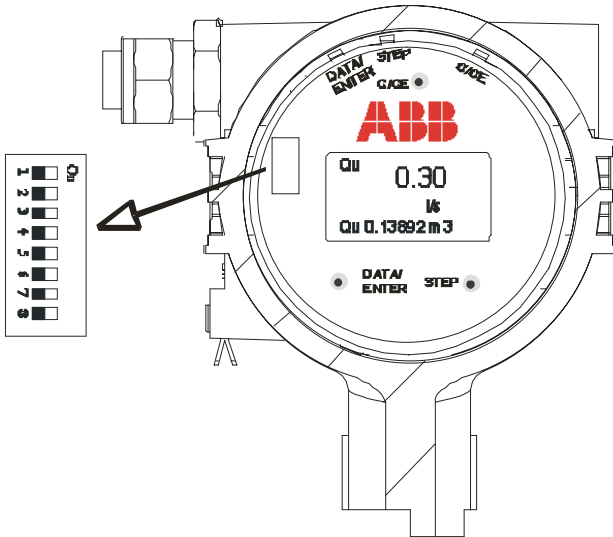

Switch 1 = Simulate Enable
off = Simulation Mode disabled
on = Simulation Mode enabled

The switch position will be displayed via the resource block within the parameter BLOCK_ERR.

Switch 2 = Write Protect (Schreibschutz)
off = Write Protect disabled (Schreibschutz inaktiv)
on = Write Protect enabled (Schreibschutz aktiv)

The switch position will be displayed via the resource block within the parameter WRITE_LOCK.

3. Start-Up

This manual is set out to provide a description of the TRIO-WIRL converter set-up using National Instruments Fieldbus Configuration System V2.3.

In addition to the instrument, you will require the following instrument-describing files for TRIO-WIRL (000320/0015):

- 0101.ffo
- 0101.sym
- 010101.cff (not required for NI-Configurator)

These files will be delivered along with the instrument on a CD-ROM which additionally includes this documentation. They can likewise be obtained via the Fieldbus Foundation Homepage www.fieldbus.org.

3.1 NI-Interface Config.

Initially, please, start the National Instruments© Program "Interface Config.". Neither the NI-FBUS configurator nor the NIFB program may be activated. Click on "DD info" and subsequently on "Import DD". Please enter the path to the ffo- (and sym-) file and press the "OK" button to import the files.

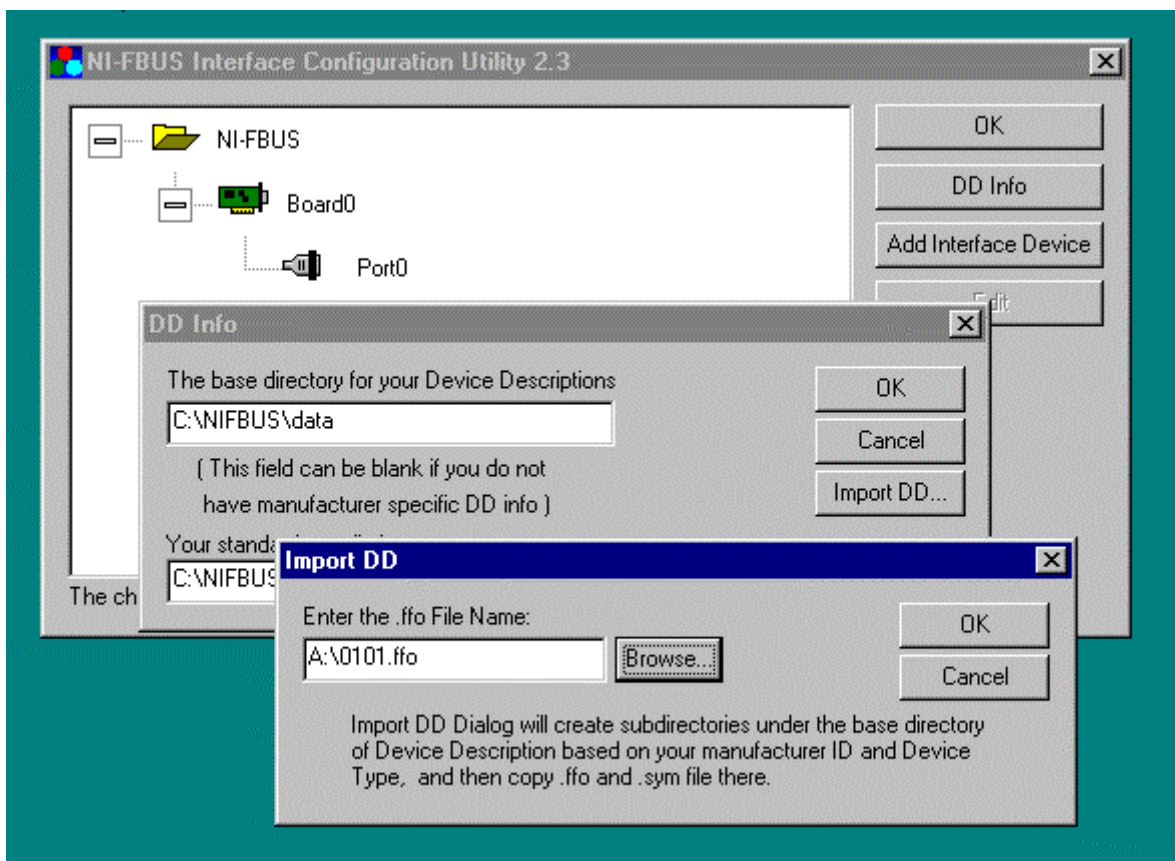

3.2 Verify Hardware switch

Please check on TRIO-WIRL, whether the hardware switches 1 and 3 are set to off (see chapter 2). Should this not be the case, please change the setting to off (also feasible during instrument operation).

3.3 Connection Establishment

Please start the National Instruments© NI-FBUS Configurator. Subsequent to the connection establishment, the following message should appear:

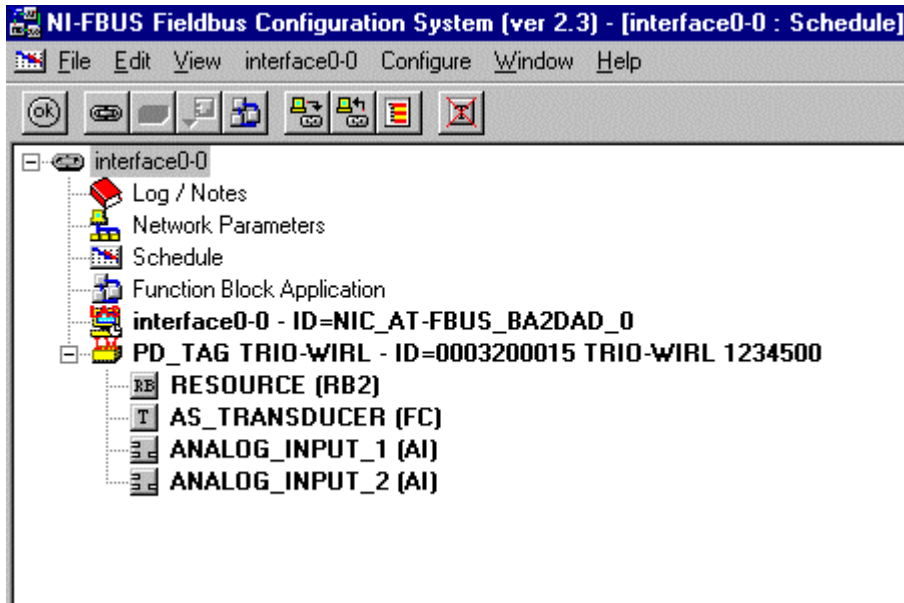

This is the identifier (ID) structure:

- 000320 = manufacturer code ABB, hex
- 0015 = Device Type Code TRIO-WIRL, hex
- TRIO-WIRL = Device name
- 12345 = serial no. of instrument expressed as 5-digit decimal figure
- 00 = double-zero always added

3.4 Blocks Out of Service

Prior to configuring the instrument, please verify whether all blocks are “out of service”. Verification can be done by opening (doubleclick on the block entry) the block display for each block:

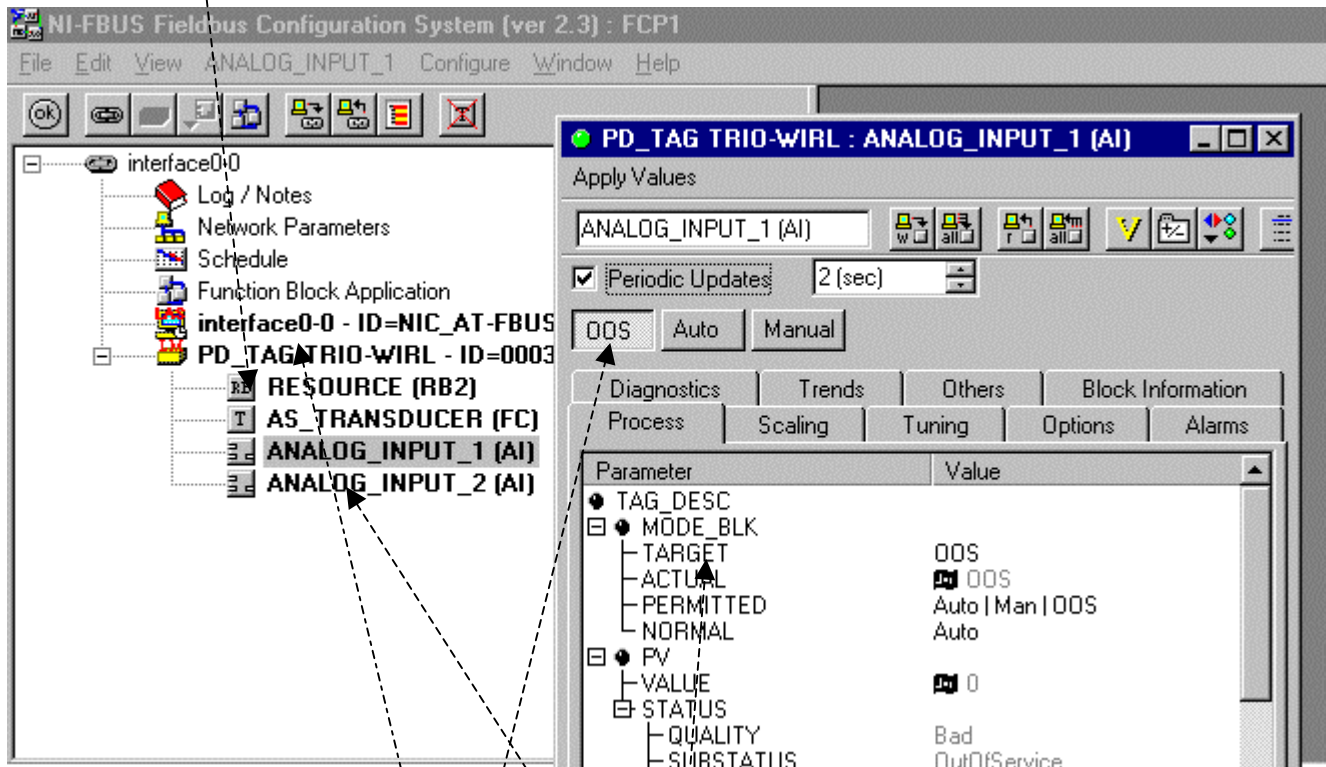

If necessary, please set blocks to “out of service”.

NOTE: Both Target Mode and Actual mode have to be set to “OOS”!

3.5 Instrument and Block Denominations

Please choose an instrument denomination.

To do so, please click on “PD_TAG TRIO-WIRL” using the right mouse button. Using SET TAG, please enter a denomination for the respective instrument.

Repeat this procedure to choose a denomination for the blocks (RB2, FC, AI1, AI2).

Should the error message “Write prohibited” appear, please verify once again, whether the “Write Protect” switch is set to off. (see 2).

As to Foundation Fieldbus, you have to imagine that the block be instrument-independent. Thus different denominations for the different devices are not sufficient. Even the blocks at the same bus have to dispose of different denominations.

3.6 Resource Block

In general, no settings have to be adjusted within the resource block. Set the block into the mode “Auto”.

3.7 Transducer Block

The transducer block contains all instrument-specific parameters of the TRIO-WIRL converter.

The parameter can be set in accordance with the application desired value. Please use the instruction manual for getting information about the specific parameter usage. Then set the block mode to “Auto”.

3.8 Analog input Block

Next you have to determine the unit handling. The measurements will be calculated within the transducer block and provided by the channels. Each channel disposes of different units (see 1.4.1). Within the AI block this value can merely be transferred (L_TYPE =direct) or the scale can be changed to another unit (L_TYPE =indirect) (see 1.3.1).

3.8.1 Unit with L_TYPE =Direct

Should within the AI block the L_TYPE (Index 16) be set to “Direct” will the structures XD_SCALE and OUT_SCALE need to be set up identically. The entry value will be directly and without transformation be transferred to OUT. The XD scale unit has to be identical with the channel unit.

Example:

The operating flow Qv shall be indicated in m3/h. Thus, please :

- Set the L_TYPE within the AI-Block to “Direct”
- Set the channel within the AI block to 1 in order to choose Qv (see 1.4.1)
- Within the transducer block (Index 54) set “Unit Qv” to m3/h. The channel 1 value then is displayed in this unit .
- Within the AI block, please set the units XD_SCALE and OUT_SCALE likewise to m3/h.
- Recommendation (not necessary): set 100%-value in XD-Scale and OUT-Scale to the QmaxDN value (Transducer-Block Index 56).
- All values in XD_SCALE and OUT_SCALE have to be adjusted identically.
- Set AI block to “Auto”.

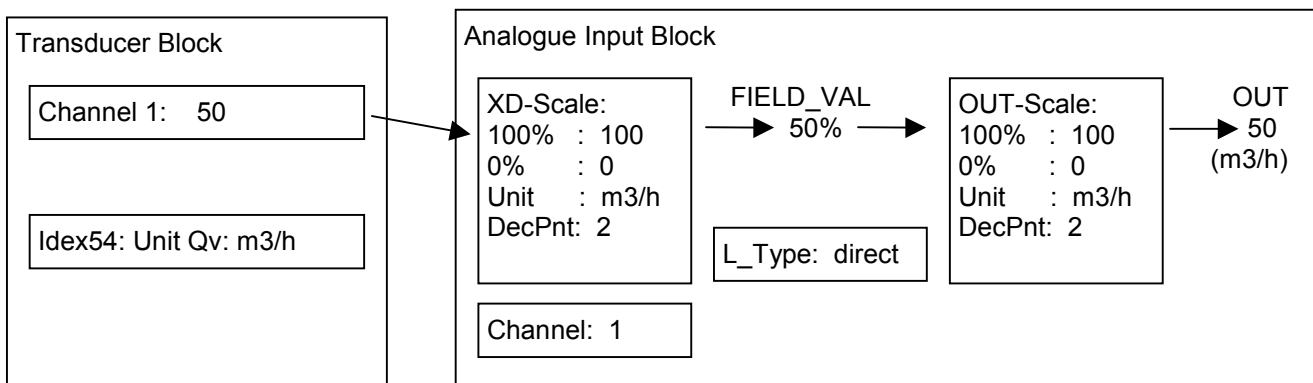

Using automatic operation mode the channel 1 value (see above example: “50”) will automatically transferred through the AI block and then be displayed as OUT value “50”.

FIELD_VAL indicates the measurement value in input-(XD)-scaling expressed in percent, in this example “50.0%”.

Info: Both the 100% and the 0% values in the XD_SCALE and OUT_SCALE do not have to be identical with the real measuring ranges of the converter. Both values do in no way represent any limit. The AI block also transfers measuring values differing from the indicated measuring range. E.g.: Taking the above example a measuring value of 200 (m3/h) will be processed without problems. FIELD_VAL would than amount to 200%.

Yet, it is recommended to adjust the AI scaling to the real measurement range. Thereto you have to either enter the QmaxDN (TB index 56) or Qmax (TB index 57) as 100% value to XD_SCALE and OUT_SCALE. The 0% value then is 0. In that case the FIELD_VAL will be indicated as a percentage of the real flow. This is important for the alarm hysteresis value(AI index 24). ALARM_HYS is a percent value related to OUT_SCALE.

NOTE: Should alarms be used, the scaling of XD_SCALE and OUT_SCALE has to comply with the real measurement range.

3.8.2 Unit with L_TYPE=Indirect

Should within the AI block the L_TYPE (index 16) be set to „indirect“, a change of scale as to the measurement value within the AI block will be effected (see 1.3.1). Using the XD_SCALE the channel value will be set to percent (= FIELD_VAL). Using the OUT_SCALE structure, the percent value will be scaled to OUT value. The XD_SCALE unit has to be identical with the channel unit.

Thus a change of scaling to any suitable unit available with Foundation Fieldbus becomes feasible.

Example:

The operating flow Qv in ML/d (MegaLiter/Day) shall be displayed. For this purpose, the conversion factor has to be known: 100 m3/h = 2400 m3/d = 2,400,000 L/d = 2.4 ML/d

Settings:

- Set L_TYPE within AI block to indirect.
- Set Channel within AI block to 1 as to choose Qv (see 1.4.1)
- Set “Unit Qv” (index 54) within transducer block to m3/h. Thus the channel 1 value will be displayed in this unit.
- Set XD_SCALE within AI block to 0 to 100 m3/h. The unit has to comply with the channel unit
- Set OUT_SCALE within AI block to 0 to 2.4 ML/d.
- Set AI block to “auto”

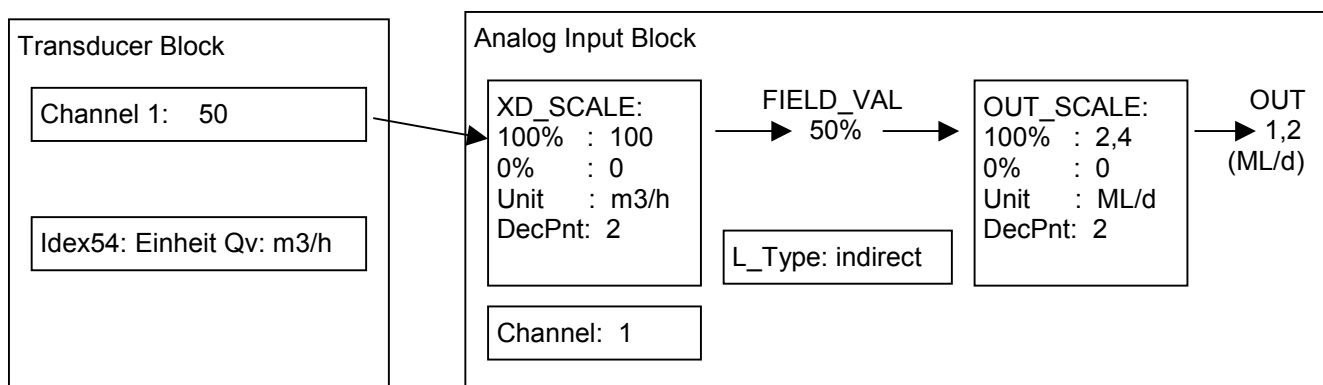

Using the XD scaling, the channel 1 value („50“ in this example) will then be automatically set to 50(%)

This value is scaled to 1.20 (ML/d) using OUT_SCALE.

Info: As is the case with L_TYPE = „direct“ the range of scaling does not necessarily have to be identical with the measurement range of the instrument. You could also scale the instrument to, say, 0 - 1000 m3/h to 0 - 24 ML/d or even 0 - 1 m3/h to 0 - 0.024 ML/d. The percent value FIELD_VAL would then differ considerably, depending on the scaling chosen.

Should you want the percent value FIELD_VAL to be displayed as a percent value off the real flow, the scaling range has to correspond to the real measurement range, i.e. to the QmaxDN or Qmax value.
 Example:

$$Q_{\max DN} = 6 \text{ m}^3/\text{h} = 6 \cdot 0.024 \text{ ML/d} = 0.144 \text{ ML/d}$$

In this case you would have to enter 0 - 6 m³/h with XD_SCALE and 0 - 0.144 ML/d with OUT_SCALE. Then FIELD_VAL will show a percentage of Q_{maxDN}, i.e. the real flow.

The alarm hysteresis ALARM_HYS (AI index 24) represents a percentage referring to OUT_SCALE.

Note: When using alarms OUT_SCALE has to correspond to the real measurement range.

Warning: With L_TYPE „indirect“ the converter does NOT verify scaling and unit of OUT_SCALE

It is feasible to choose any sensible or insensible unit. The above example could for example also be scaled at 0-100 m³/h to 0-100 kg/h, which, under certain circumstances could well be considered sensible. Yet, the scaling could also be set at 0-100 m³/h to 0-100 Celsius, which, of course, makes no sense at all.

There is, of course, always a risk of faulty scaling. You could, e.g., set a scaling from 0 – 100 m³/h to 0-100 ML/d, which would be incorrect.

This behaviour refers to the Foundation Fieldbus AI blocks. The operator takes the responsibility of correctly setting the scale.

3.8.3 Summary AI block settings

Minimum settings:

- Valid channel
- L_TYPE: direct or indirect
- XD_SCALE
- OUT_SCALE

It is recommended to work with L_TYPE direct in order to avoid errors during change of scaling.

The following pictures show the settings at the National Instruments© NI-FBUS Configurator:

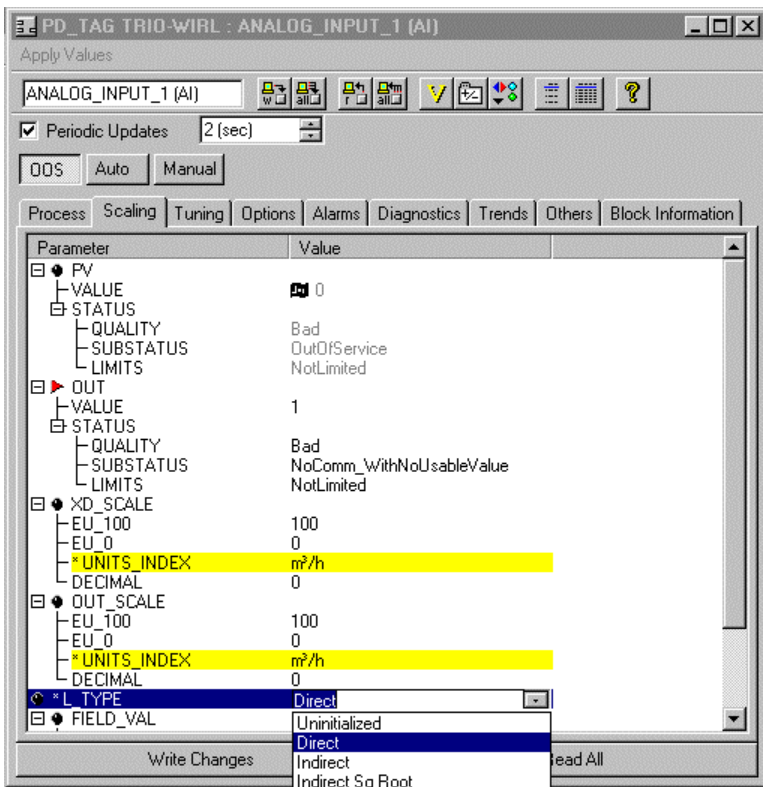
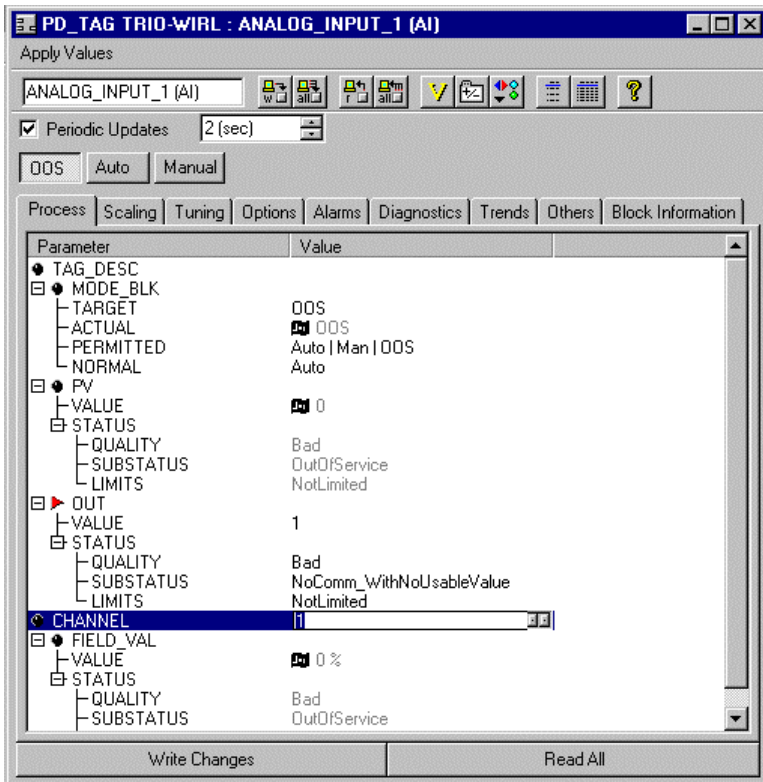

3.9 PERIOD_OF_EXECUTION

Within the AI block view choose the tab „Block Information”. Should this tab not be visible, close the block view window and choose from the menu bar of the main window:

View→ Preferences→ Block View

And then activate “Show Block Information”. Open the AI block view again and look into the tab “Block Information”. The parameter PERIOD_OF_EXECUTION indicates in which intervals the function block should be processed. The time basis is 1/32 msec.

An PERIOD_OF_EXECUTION other than 0 (e.g. 32000 corresponds to 1sec) means that the block is already being processed regularly. In this case, the block can be set to “auto”.

Should the PERIOD_OF_EXECUTION be set to 0 it means that the block has not yet been included in the temporal processing. In this case it will not be feasible to set the block to auto mode prior to creating a schedule for block processing.

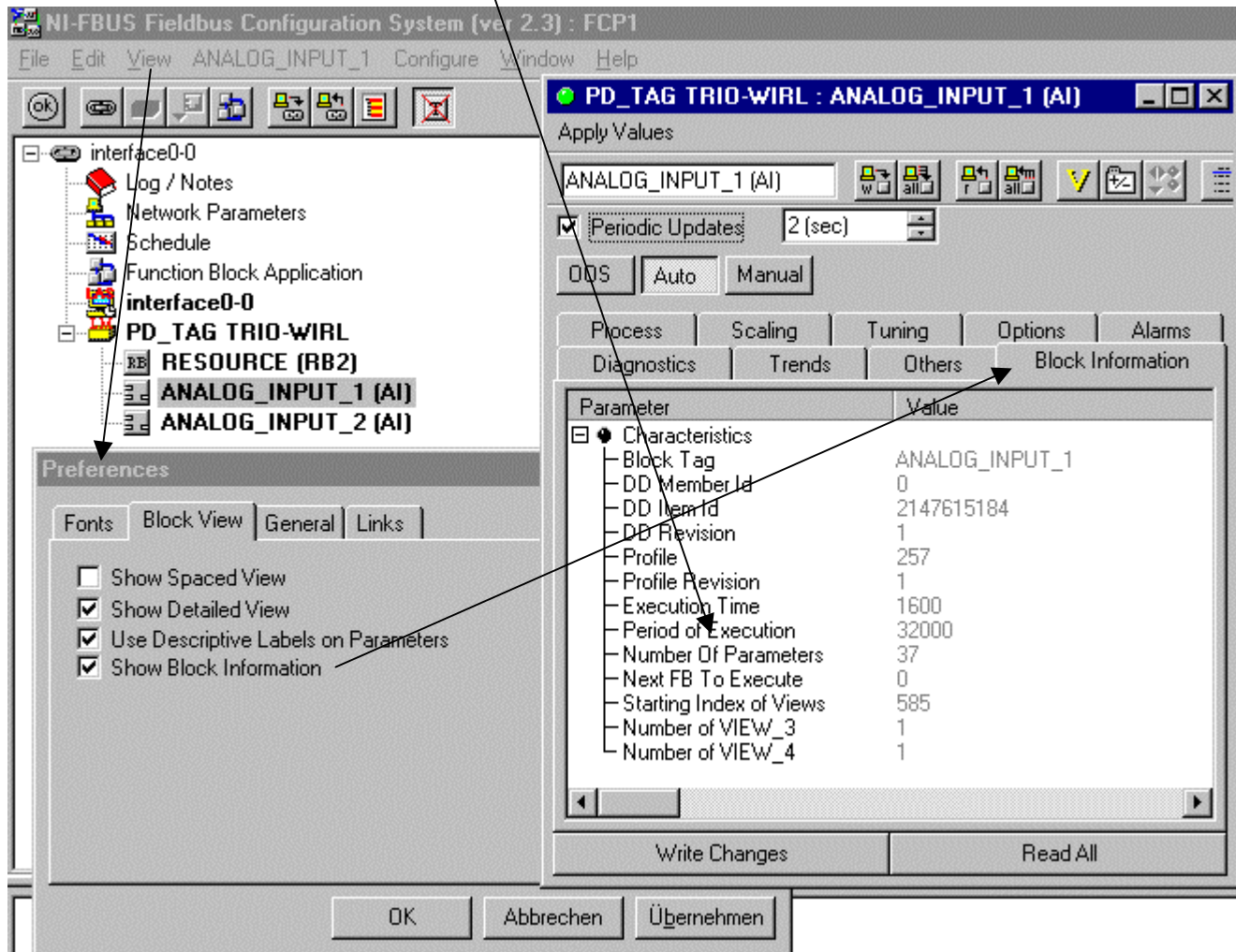

3.10 Scheduling

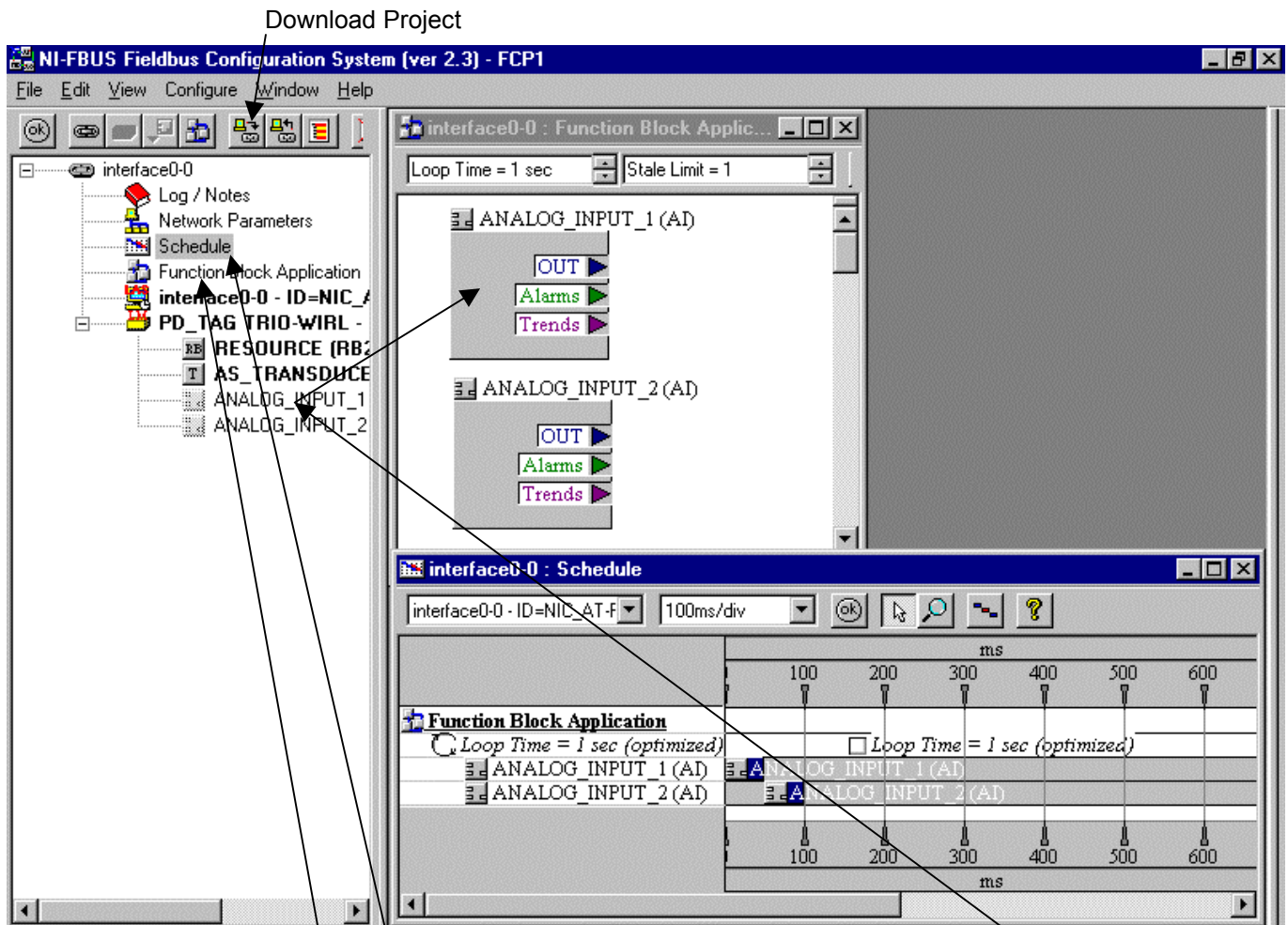

Please double-click on „Function Block Application“ to open this window. Then click on “Analog_Input_1” using the left mouse button. Keep the mouse button down. Drag the AI 1 symbol in the “Function Block Application” window. Should you want to make likewise use of AI2, repeat the above-mentioned procedure.

For information, please open the schedule window. The loop time within the “Function Block Application” window is set to a default value of 1 sec. From the schedule window it can be seen which blocks are to be processed in this loop and in which order of processing. In this example it would merely be the block AI1 and AI2. The execution time of the AI blocks amounts to 50msec. This information will be displayed in the block information within the AI window: $1600 / (32\text{msec}) = 50\text{msec}$.

At least the OUT parameter coming from the AI blocks would in general be connected with other block inputs. For this reason you would have to enter further blocks from other instruments at the bus into the “Function Block Application” and connect the in and outputs of the blocks. For testing purposes of a single device, however, there is no need for such a connection (see above picture).

Click on “Download Project” to download this configuration into your instrument. Choosing “Automatic Mode Handling” within the download window guarantees that the target mode of resource and AI block will, during the downloading process, be first set to “Out of Service” and then to “Auto”. Should “Automatic Mode Handling” not have been activated you are forced to manually acknowledge the change of mode. If, at the very end of the download, the target mode is not set to “normal mode” (=Auto), please make up for it for the resource and the AI blocks after completion of download. The “Actual Mode” of these blocks should likewise change to “Auto”.

3.11 Device Display

Der TRIO-WIRL is equipped with a four line LCD. In the submenu „Display“ the content of the display is set (see auf rel. index 73 upto 76 in transducer block). The following selections are possible:

- 6 : AI1 Out
- 7 : AI1 Status
- 8 : AI2 Out
- 9 : AI2 Status

3.11.1 AI1 Out and AI2 Out

The out value of the choosen AI block is displayed (AI1 or AI2). The number of digits right to decimal point are set by the value in Decimal-Point in the OUT_SCALE structure. The displayed value is UNIT_INDEX of the OUT_SCALE structure:

AI1 123.45 1/s

3.11.2 AI1 Status and AI2 Status

The actual mode of the choosen block and the status of OUT is displayed:

AI1 AUTO GOOD

Right to the status the substatus if available is displayed as number.

Example :

BAD 4 means status is BAD, Substatus 4 = Sensor failure (Substatus codes see chapter 1.6).

3.12 Error Detection

3.12.1 Write parameters

The following error messages can appear while writing parameters using NI configurator:

Write is prohibited (Error code 40)

1. Check whether the write protect switch is deactivated (see 2). This can be checked at the instrument (switch position) or checking the the WRITE_LOCK parameter (to be found within the NI configurator in the resource block window below the tab “options”). This parameter indicates the status of the write protector switch and supplies the message “Locked” or “Not Locked”.
2. The respective parameter can (with current configuration) not be written. See description of respective parameter.

Wrong Mode for Request (Error code 39)

Each block disposes of a mode structure. This is composed of four single parameters:

- Target desired operating mode, e.g. Auto
- Actual current operating mode. Should the target be set to auto and a configuration error is detected, will the actual mode be remain to “Out of Service”.
- Permitted Includes all possible operating modes. I.e. with an AI block: Out of service, Man, Auto
- Normal normal operating mode, with AI block: Auto

Some parameters can merely be written if the target is set to „Out of Service“. Other parameters can also be written in “Man” and still others can be written in each of the target modes. For more detailed information, see block description

Exceed Limit (Error code 38)

It was attempted to write a value exceeding the permitted limits of a parameter. Refer to the parameter description to learn which limits and values respectively are permitted.

3.12.2 AI-Block cannot be set to auto

The Auto mode of an AI block requires the following conditions :

1. The resource block has to be set to auto. No other pre-conditions.
2. Within the AI block a valid channel has to be entered (1-5).
3. L_Type has to be set to direct or indirect (indirect square root is likewise possible)
4. XD-SCALE unit has to be identical with channel unit (see also 1.4.1).
5. With L_Type „Direct the XD_SCALE and OUT_SCALE structures have to be identical
6. The PERIOD_OF_EXECUTION of the AI block has to be of a value other than 0

Should these conditions be met and the target mode of the AI block be set to auto, will the actual mode and thus the block itself be set to auto.

Whether these conditions are met or not can be taken from the parameter BLOCK_ERR (within the NI configurator in the AI window below the tab diagnostics). Should the Block Configuration Error appear, please check which of the above mentioned conditions 1-6 has not been met.

If the PD_Tag of the device is changed or the Tag of the Resource- or Analog Input Block behind downloading of a schedule, it may be not possible to switch the AI-blocks to auto although the conditions are met. In this case create a new schedule with the “new” Blocks (=new Tags= new designations) and download the new schedule into the device.

Rights reserved to make technical revisions.

This Instruction Bulletin is copyright protected. Translations, reproductions or distribution in any form - including editing and abstracts - and in particular, duplicating, photocopying, electronic distribution or storing in data processing installations or networks without the express consent of the copyright holder is strictly forbidden and may lead to civil or criminal proceedings.



ABB Automation Products GmbH
Dransfelder Str. 2, D-37079 Goettingen
Tel.: +49 (0) 5 51 9 05 - 0
Fax: +49 (0) 5 51 9 05 - 777
<http://www.abb.com>

Rights reserved to make technical revisions
Printed in the Fed. R. of Germany
D184B093U24 Rev. 01
Issued 03.02

Rights reserved to make technical revisions.

This Instruction Bulletin is copyright protected. Translations, reproductions or distribution in any form - including editing and abstracts - and in particular, duplicating, photocopying, electronic distribution or storing in data processing installations or networks without the express consent of the copyright holder is strictly forbidden and may lead to civil or criminal proceedings.



ABB Automation Products GmbH
Dransfelder Str. 2, D-37079 Goettingen
Tel.: +49 (0) 5 51 9 05 - 0
Fax: +49 (0) 5 51 9 05 - 777
<http://www.abb.com>

Rights reserved to make technical revisions
Printed in the Fed. R. of Germany
Rev.
Issued

Rights reserved to make technical revisions.

This Instruction Bulletin is copyright protected. Translations, reproductions or distribution in any form - including editing and abstracts - and in particular, duplicating, photocopying, electronic distribution or storing in data processing installations or networks without the express consent of the copyright holder is strictly forbidden and may lead to civil or criminal proceedings.



ABB Automation Products GmbH
Dransfelder Str. 2, D-37079 Goettingen
Tel.: +49 (0) 5 51 9 05 - 0
Fax: +49 (0) 5 51 9 05 - 777
<http://www.abb.com>

Rights reserved to make technical revisions
Printed in the Fed. R. of Germany
Rev.
Issued

Rights reserved to make technical revisions.

This Instruction Bulletin is copyright protected. Translations, reproductions or distribution in any form - including editing and abstracts - and in particular, duplicating, photocopying, electronic distribution or storing in data processing installations or networks without the express consent of the copyright holder is strictly forbidden and may lead to civil or criminal proceedings.



ABB Automation Products GmbH
Dransfelder Str. 2, D-37079 Goettingen
Tel.: +49 (0) 5 51 9 05 - 0
Fax: +49 (0) 5 51 9 05 - 777
<http://www.abb.com>

Rights reserved to make technical revisions
Printed in the Fed. R. of Germany
Rev.
Issued

Rights reserved to make technical revisions.

This Instruction Bulletin is copyright protected. Translations, reproductions or distribution in any form - including editing and abstracts - and in particular, duplicating, photocopying, electronic distribution or storing in data processing installations or networks without the express consent of the copyright holder is strictly forbidden and may lead to civil or criminal proceedings.



ABB Automation Products GmbH
Dransfelder Str. 2, D-37079 Goettingen
Tel.: +49 (0) 5 51 9 05 - 0
Fax: +49 (0) 5 51 9 05 - 777
<http://www.abb.com>

Rights reserved to make technical revisions
Printed in the Fed. R. of Germany
Rev.
Issued