

Transformer Terminal

Product Guide

**RET 541,
RET 543,
RET 545**



Features

- Transformer terminal for protection, control, measurement and supervision of two-winding power transformers and generator-transformer blocks in distribution networks
- Designed to withstand harsh environments e.g. in heavy industry, marine and offshore applications
- Three-phase current differential protection with stabilized and instantaneous stages for fast and selective winding short-circuit and interturn fault protection as main protection
- Fast and reliable operation even with saturating CTs
- Numerical implementation of vector group matching allows wye-connection of measuring CTs as standard without interposing CTs, irrespective of transformer vector group
- Restricted earth-fault protection with the conventional high impedance principle or the stabilized numerical principle
- Three-phase overcurrent and earth-fault back-up protection with definite time and IDMT characteristics for both windings
- Thermal overload and negative phase sequence protection
- Additional protection functions available in the Multi-version terminal: overexcitation, overvoltage, undervoltage, residual overvoltage, directional overcurrent and earth-fault, overfrequency, underfrequency and underimpedance line back-up protection
- Large graphic display, either integrated or as an external module
- Control functions including local and remote control of switching objects, including object status indication and interlockings on bay and substation level
- Optional automatic on-load tap-changer control function for single or parallel transformers using the Master-Follower, Negative Reactance or Minimizing Circulating Current principles
- Supports several methods to interface tap-changer position information to differential protection and voltage regulator
- Measurement of two sets of three-phase currents, phase-to-phase or phase to neutral voltages, neutral current, residual voltage, frequency, power factor, active and reactive power and energy
- Condition monitoring including circuit-breaker condition monitoring, trip circuit supervision and internal self-supervision of the transformer terminal
- Extensive set of integrated communication protocols: SPA, LON, IEC 60870-5-103, Modbus RTU/ASCII, DNP 3.0
- Interface to Profibus DP and IEC 61850 based systems via adapters
- Part of ABB's substation automation system

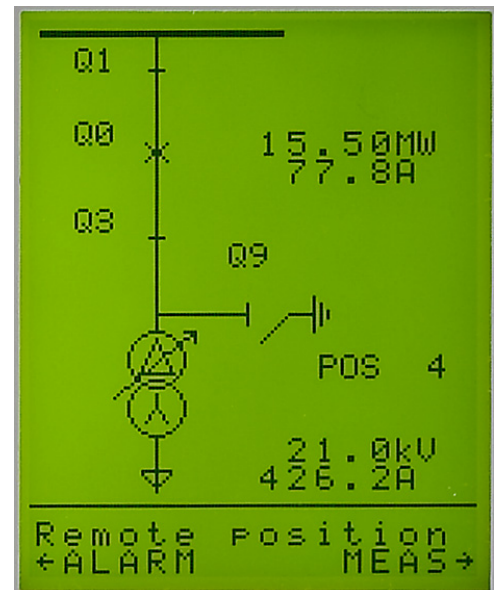

Fig. 1 Mimic view of RET 54_{transformer terminal}.
ret54_mimic_co180dpi

Application

The RET 541/543/545 transformer terminals are designed to be used for the protection, control, measurement and supervision of two-winding power transformers and generator-transformer blocks in distribution networks. RET 54_ terminals can also be used in harsh environments e.g. in heavy industry, marine and offshore applications.

The main protection function is three-phase current differential protection with stabilized and instantaneous stages for fast and selective winding short-circuit and interturn protection. Besides 2nd and 5th harmonic restraints, the stabilized stage also includes a waveform recognition-based blocking-deblocking feature. Reliable operation even with partially saturated current transformers, that is, short operate times at faults occurring in the zone to be protected and high stability at external faults are achieved. Increased sensitivity can be obtained by automatic adaptation to the position changes of the on load tap changer. Interposing current transformers are not needed: Any vector group matching and CT ratio corrections in a wide range are numerically implemented as well as zero-sequence current elimination, which prevents unwanted trips at earth faults occurring outside the protected area.

In addition to the differential protection, the *Basic* version terminals incorporate the following protections: Restricted earth fault protection with stabilized numerical or high impedance principle, unbalance and thermal overload protections, three phase overcurrent and non-directional earth fault back-up protection with definite and IDMT characteristics on both sides of the transformer.

The *Multi*-version terminals, further including overvoltage and undervoltage, residual overvoltage, underfrequency and overfrequency, overexcitation, directional earth-fault, directional overcurrent and under-impedance line back-up protections fulfill the most demanding application requirements.

Enhanced with the optional automatic voltage regulation function, the RET 54_ terminal can be applied as a comprehensive integrated transformer management terminal. The voltage regulator can be applied for a single transformer or for parallel transformers with Master-Follower, Negative Reactance or Minimizing Circulating Current principles.

A special control version terminal with voltage regulator and control functions can be applied, when integration of voltage regulation and protection is not allowed.

The graphical configuration tool, based on the IEC 61131-3 standard, enables easy creation of application-specific configurations and MIMIC pictures corresponding to different switchgear systems. The process status is shown on a dynamic large graphical display. Detailed information, for instance, measured values, events and application-specific alarms, are presented in the display views.

The RET 54_ terminals can measure two sets of three phase currents, phase-to-phase or phase-to-earth voltages, neutral current, residual voltage, frequency and power factor. Active and reactive power is calculated from the measured currents and voltages. Energy can be calculated on the basis of the measured power. The measured values can be indicated locally and remotely as scaled primary values.

With the condition monitoring functions the RET 54_ transformer terminal monitors e.g. trip circuits, gas pressure of the breaker and breaker wear and provides scheduled time intervals for maintenance.

The RTD1 card, available as an option to the RET 541 and RET 543 terminals, provides versatile analog inputs enabling e.g. tap position supervision of the on load tap changer, RTD inputs for top and bottom oil temperature monitoring, and ambient temperature biasing for accurate thermal overload protection. The mA outputs allow transfer of any measurement data e.g. to PLCs.

By means of the graphic HMI display, the control functions in the transformer terminal indicate the position of disconnectors, circuit breakers and tap changer locally. Local control of these objects is possible via the push buttons on the front panel of the terminal. Furthermore, the terminal allows position information of the objects to be transmitted to the remote control system. Controllable objects, such as CBs, can also be opened and closed over the remote control system.

Supporting a wide range of communication protocols, including SPA, LON, IEC 60870-5-103, DNP 3.0 and Modbus RTU/ASCII, commonly used by utilities and industries, the terminals are flexibly integrated into different control systems. Connection to Profibus DP or IEC 61850 based system is possible via the interface adapters SPA-ZC 302 or SPA-ZC 400, respectively.

Design

The transformer terminals RET 541, RET 543 and RET 545 differ from each other regarding the number of digital inputs and outputs available. Please, refer to section “Ordering” for more details.

The functions of the RET 54_ transformer terminal are categorized as:

- protection functions
- measurement functions
- control functions
- condition monitoring functions
- communication functions
- general functions
- standard functions

The functions are further divided to three subsets that correspond to different functionality levels, refer to section “Ordering Information”

Protection functions

Protection is one of the most important functions of the RET 54_ transformer terminal. The protection function blocks (e.g. NOC3Low) are independent of each other and have e.g. their own setting groups and data recording.

The protection function blocks are documented on the CD-ROM “Technical Descriptions of Functions” (1MRS750889-MCD)

Measurement functions

The measurement function blocks are documented on the CD-ROM “Technical Descriptions of Functions” (1MRS750889-MCD)

Control functions

The control functions are used to indicate the position of switching devices, i.e. circuit breakers and disconnectors, and to execute open and close commands for controllable switching devices in the switchgear. Furthermore, there are supplementary functions for control logic purposes, e.g. on/off switches, MIMIC alarm, LED control, numerical data for the MIMIC and logic controlled position selection.

The control functions configured using the Relay Configuration Tool can be associated with position indicators that are part of the MIMIC configuration picture displayed on the HMI. Position indicators are used to indicate the position of switching devices via the MIMIC picture and to control them locally.

The control function blocks are documented on the CD-ROM “Technical Descriptions of Functions” (1MRS750889-MCD)

Condition monitoring functions

The condition monitoring function blocks are documented on the CD-ROM “Technical Descriptions of Functions” (1MRS750889-MCD)

General functions

Additional functions are available for different general purposes to be used in logics such as activation of HMI backlight, switchgroups, and resetting of operation indications, latched output signals, registers and disturbance recorder.

Communication functions

The RET 54_ transformer terminal provides the IEC_103, Modbus, DNP 3.0, SPA and LON serial communication protocols.

In a customer-specific transformer terminal configuration, special events can be generated via an EVENT230 event function. EVENT230 is documented on the CD-ROM “Technical descriptions of Functions” (1MRS750889-MCD).

Standard functions

Standard functions are used for logics, such as interlocking, alarming and control sequencing. The use of logic functions is not limited and the functions can be interconnected with each other as well as with protection, measurement, power quality, control, condition monitoring and general functions. In addition, the digital inputs and outputs as well as LON inputs and outputs can be connected to standard functions by using the Relay Configuration Tool.

The standard function blocks are documented on the CD-ROM “Technical descriptions of Functions” (1MRS750889-MCD).

Other functions

Low auxiliary voltage indication

The RET 54_ transformer terminal is provided with a low auxiliary voltage indication feature. The power supply module issues an internal alarm signal when a drop in the power supply voltage is detected (ACFail, active low). The alarm signal is activated if the power supply voltage falls about 10% below the lowest rated DC input voltage of the power supply module.

Design (cont'd)

The indication of a low auxiliary voltage is available in the transformer terminal configuration and can be connected to any signal output of the RET 54_.

Overtemperature indication

The RET 54_ transformer terminal includes an internal temperature supervision function. The power supply module issues an internal alarm signal when overtemperature has been detected inside the terminal enclosure. The alarm signal will be activated once the temperature inside the terminal enclosure increases to $+78^{\circ}\text{C}$ ($+75^{\circ}\dots+83^{\circ}\text{C}$). Overtemperature indication is available in the transformer terminal configuration and can be connected to any signal output of the RET 54_.

Analog channels

The transformer terminal measures the analog signals needed for protection, measuring, etc. via galvanically separated matching transformers.

RET 54_ transformer terminals have 9 analog channels. Furthermore, the transformer terminal includes virtual analog channels for calculating the residual current and residual voltage from phase currents and voltages. Both the amplitude and the phase angle are calculated for the virtual channels.

Note! When sensitive earth-fault protection is needed, core balance transformers are not recommended to be replaced with the numerically derived sum of phase currents. Normally, an earth-fault setting below 10% of the rated value requires the use of a core balance transformer.

Analog channels of the transformer terminal are configured with the CAP 505 Relay Product Engineering Tools.

A separate scaling factor can be set for each analog channel. The factors enable differences between the ratings of the protected unit and those of the measuring device (CT and VT ratio corrections). The setting value 1.00 means that the rated value of the protected unit is exactly the same as that of the measuring device.

Digital inputs

The digital inputs of the transformer terminals are voltage controlled and optically isolated with three threshold voltages defined by the order, see chapter "Ordering". The func-

tion of a digital input can be inverted. The programmable filter time removes debounces and short disturbances on a digital input. The filter time can be set for each digital input separately.

Some specific digital inputs can be programmed to operate either as digital inputs, as pulse counters or as used for time synchronization. When a digital input operates as a pulse counter, pulse counting frequency can be up to 100 Hz.

Oscillation suppression

The transformer terminals have two global parameters for the suppression of digital input oscillation. The settings of these parameters determine the oscillation level and hysteresis for all digital inputs. Event is generated in case oscillation is detected.

Attributes of a digital input for transformer terminal configuration

For each digital input, the status of the input (value), the time tag for the status change (time) and the validity of the digital input (invalidity) can be issued by the attributes. These attributes are available in the transformer terminal configuration and can be used for various purposes.

RTD/analog inputs

The RET 541 and RET 543 transformer terminals equipped with an RTD/analog module (RTD1) have eight general purpose analog inputs for DC measurement. The RTD/analog inputs are galvanically isolated from the transformer terminal power supply and enclosure. However, the inputs have a common ground. The general purpose RTD/analog inputs accept voltage-, current- or resistance-type signals. For each measuring mode, a separate parameter is provided for choosing between the available measurement ranges. RTD/analog inputs can be applied for e.g. temperature measurement.

Digital outputs

The outputs of the transformer terminal are categorized as follows:

- HSPO: High-speed power output, double-pole contact, preferred for tripping purposes and for circuit breaker and disconnect control
- PO: Power output, either single-pole or double-pole contact, preferred for circuit breaker and disconnect control

- SO: Signal output, either NO (Normally Open) or NO/NC (Normally Open/Normally Closed) contact. The output contact is a normal-duty contact and cannot be used for controlling a heavy load such as a circuit breaker.

Analog outputs

The RET 541 and RET 543 transformer terminals equipped with an RTD/analog module have four general purpose 0...20 mA analog current outputs. All outputs are galvanically isolated from the supply and enclosure of the transformer terminal and from each other.

Analog outputs can be utilized for transferring any measured or calculated information to panel meters or e.g. PLCs.

Alarm LED indicators

The transformer terminal offers eight alarm LED indicators to be configured with the Relay Mimic Editor. The LED colours (green, yellow, red), their use, and the ON and OFF state texts can be freely defined. Three basic

operation modes are supported: non-latched, latched-steady and latched flashflashing. Alarms can be acknowledged remotely, locally or by using logic of the transformer terminal.

The alarm channels include time tagging for detected alarms. The time tagging principle used depends on the operation mode.

Interlocking LED indicator

The interlocking LED indicates that control operation has been interlocked or that the interlocking is in bypass mode, e.g. when control is possible despite of interlocking.

Trip Circuit Supervision

The purpose of this function is to supervise the tripping circuitry of the circuit breaker. An alarm will be generated in case a faulty tripping circuit, e.g. a circuit is not able to perform a trip, is detected.

The supervision is based on the constant-current injection through the tripping circuitry.

Display panel

The transformer terminal is provided with either a fixed display or an external display module. The external display module requires a separate voltage supply from a common source with the main unit. The display consists of 19 rows divided into two windows: a main window (17 rows) and an assisting window (2 rows).

The graphic display presents detailed information on MIMIC, objects, events, measurements, control alarms, and parameters. The assisting window is used for terminal-dependent indications/alarms and help messages.

Additionally, the panel includes the following HMI items:

- three push-buttons for object control (I, O, object selection)

- eight freely programmable alarm LEDs with different colours and modes according to the configuration
- LED indicator for control interlocking
- three protection LED indicators
- HMI push-button section with four arrow buttons and buttons for clear and enter
- optically isolated serial communication port
- backlight and contrast control
- freely programmable button (F) which can be used in the configuration of the transformer terminal
- a button for remote/local control

HMI has two main levels, the user level and the technical level. The user level is for “everyday” measurements and monitoring whereas the technical level is intended for advanced transformer terminal programming. Unauthorized access can be prevented with passwords.

Serial communication

The transformer terminal has three serial communication ports, one on the front panel and two on the rear panel.

The standard optical ABB connector

The standard optical ABB connector (RS-232 connection) on the front panel is intended for the connection of a PC for configuring the transformer terminal with the CAP 50_ tools. The front interface uses the SPA bus protocol.

SPA/IEC_103/DNP 3.0/Modbus communication on the rear connector X3.2

The 9-pin D-type subminiature male connector (RS-232 connection) on the rear panel connects the transformer terminal to the distribution automation system via the SPA bus, IEC_103, DNP 3.0 or Modbus. The fibre-optic interface module type RER 123 is used to connect the transformer terminal to the fibre-optic communication bus for SPA and

IEC 103 protocols. RS-485 interface module RER 133 is used to connect the transformer terminal to the RS-485 communication bus for DNP 3.0 and Modbus.

LON/SPA bus communication on the rear connector X3.3

The 9-pin D-type subminiature female connector (RS-485 connection) on the rear panel connects the transformer terminal to the substation automation system via the SPA bus or the LON bus. The fibre-optic interface module type RER 103 is used to connect the transformer terminal to the fibre-optic communication bus. The RER 103 module supports both SPA bus and LON bus communication. The SPA-ZC 302 is an interface module that provides connectivity to the Profibus DP fieldbus and SPA-ZC 400 interface module provides connectivity to the IEC 61850-8-1 Station bus.

Self-supervision

The transformer terminal RET 54_ is provided with an extensive self-supervision system. The self-supervision system handles run-time fault situations and informs the user of faults via the HMI and LON/SPA bus communication.

When a fault has been detected, the green Ready indicator starts flashing, a fault indication text is displayed on the HMI and an event 0/E57 is generated. The fault indication text on the HMI consists of two rows: a general message 'internal fault', followed by the generated IRF code of the fault.

The relay will try to recover from a fault either by restarting the module (I/O module or HMI) that reported the fault, or by restarting the whole relay. During restarting the IRF state will remain active until the internal self-supervision program has determined that the relay is operating normally. If the fault is still persistent after restarting three times, the relay will be in permanent IRF state.

Transformer terminal configuration

The Relay Configuration Tool, based on the IEC 61131-3 standard and included in the CAP 505 Relay Product Engineering Tools, is used for configuring the basic terminal, protection and logic function blocks, control and measurement functions, timers and other functional elements included in the logic functions category.

The programmable system of RET 54_ transformer terminals allows the output contacts to be operated in accordance with the state of the logic inputs and the outputs of the protection, control, measurement and condition monitoring functions. The PLC functions (e.g. interlocking and alarm logic) are programmed with Boolean functions, timers, counters, comparators and flip-flops. The program is written in a graphic function block diagram language by using the configuration software.

Mimic configuration with Relay Mimic Editor

The Relay Mimic Editor, which is included in the CAP 505 Relay Product Engineering Tools, is used for configuring the graphic display and the alarm channels of the transformer terminal. The mimic configuration may include circuit breakers, disconnectors, indicators, measurement data objects and user-defined texts and explanations. Any configuration can be saved for later use.

All of the eight alarm function blocks can be configured in the same alarm view of the mimic editor. ON and OFF state texts (only one language version at a time can be supported for the alarm) and LED colours can be defined. Three different colours can be used to define the ON and OFF state. Three basic modes are available:

- non-latched
- latched-steady
- latched flashing

Interlocking LED texts can also be defined in the same alarm view but the colour of the interlocking LED cannot be changed.

LON network configuration

The LON Network Tool is used for binding network variables between the transformer terminal units. Typically, LON horizontal communication is used for transferring object status data (open, close, undefined) between units for interlocking purposes. Additionally, LON horizontal communication is used to transfer measured current amplitude and phase angle information between terminals, when parallel control with MCC principle is to be applied.

DNP 3.0 and Modbus configuration

The Protocol Mapping Tool is used for configuring the DNP 3.0 and Modbus interfaces of the transformer terminal.

Transformer terminal parameterization

The parameters of the transformer terminal units can be set either locally over the HMI or externally via the serial communication using the Relay Engineering Tools CAP 501/505.

Local parameterization

When the parameters are set locally, the setting parameters can be chosen from the hierarchical menu structure. The desired language for parameter description can be selected.

External parameterization

The Relay Setting Tool is used for parameterizing and setting the transformer terminals externally. The parameters can be set off-line on a PC and downloaded to the transformer terminal over a communication port. The menu structure of the setting tool, including views for parameterization and settings, is the same as the menu structure of the transformer terminal.

Auxiliary voltage

For its operation, the RET 54_ terminal, including the external display module, requires a secured auxiliary voltage supply. The terminal's internal power supply module forms the voltages required by the terminal electronics. The power supply module is a galvanically isolated (fly-back type) dc/dc converter. A green protection LED indicator on the front panel is lit when the power supply module is in operation.

Power supply modules

There are two basic types of power supply modules available for the RET 54_: type PS1/_ and type PS2/_. The operating range of digital inputs depends on the type of the power supply module. See Technical data.

Terminal connections

All external circuits are connected to the terminal blocks on the rear panel, see figures 2...4. The terminal block for the measuring transformers consists of fixed screw terminals.

The serial interface RS-232 on the rear panel is used for connecting the transformer terminal to the SPA bus, the IEC_103, DNP 3.0 or Modbus. The SPA/IEC_103 is connected via a connection module type RER 123 fitted to the 9-pin D-type subminiature connector and screwed to the rear panel. DNP 3.0/Modbus is connected via a connection module, type RER 133.

The serial interface RS-485 on the rear panel is used for connecting the transformer terminal to the SPA bus or the LON bus. The SPA/LON bus is connected via a connection module type RER 103 fitted to the 9-pin D-type subminiature connector and screwed to the rear panel.

The digital input and output contacts of the transformer terminal are connected to the multi-pole connectors.

Protective earth is connected to the screw marked with the earth symbol.

Terminal diagrams

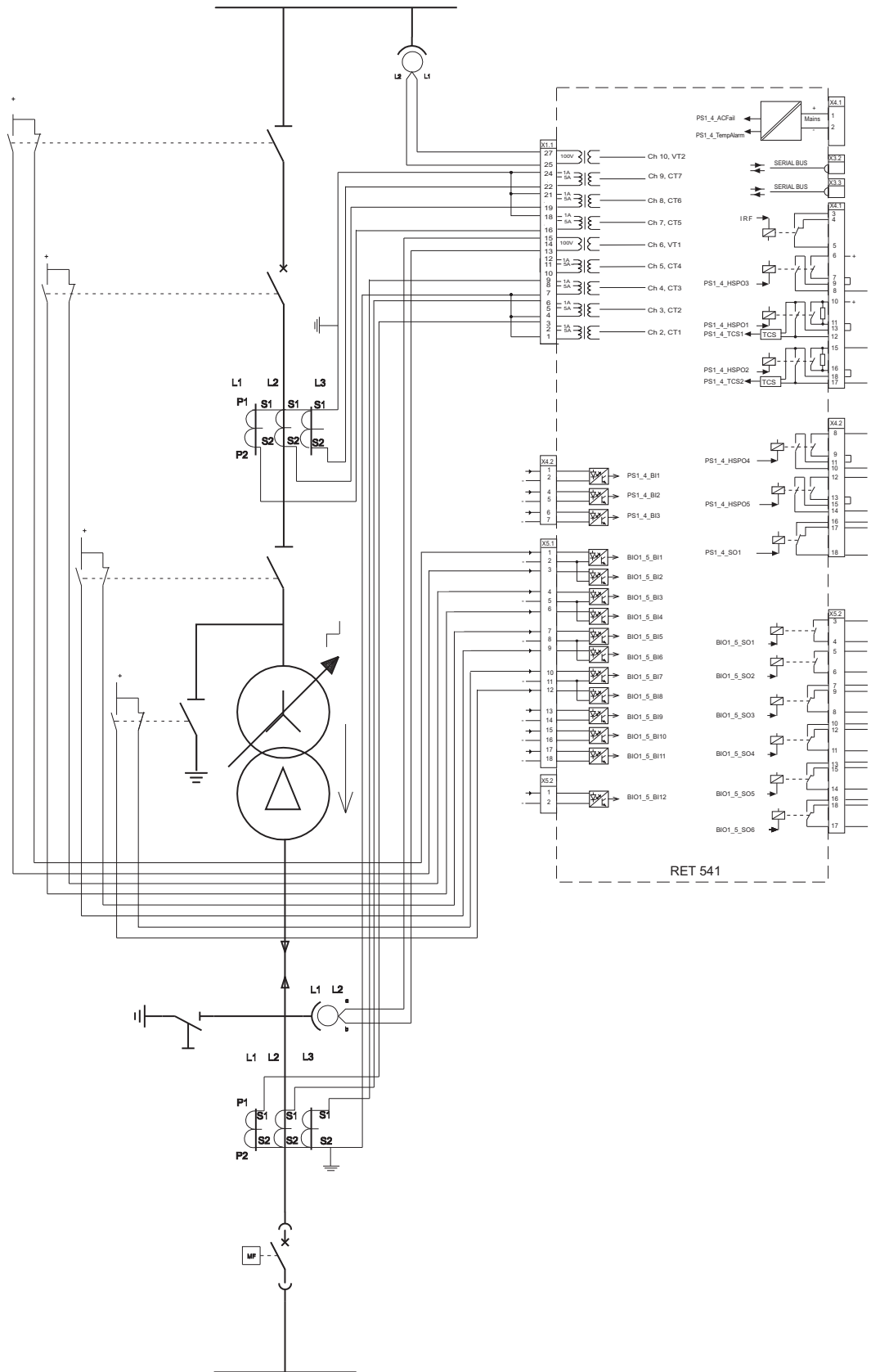

Fig. 2 Sample connection diagram of RET 541

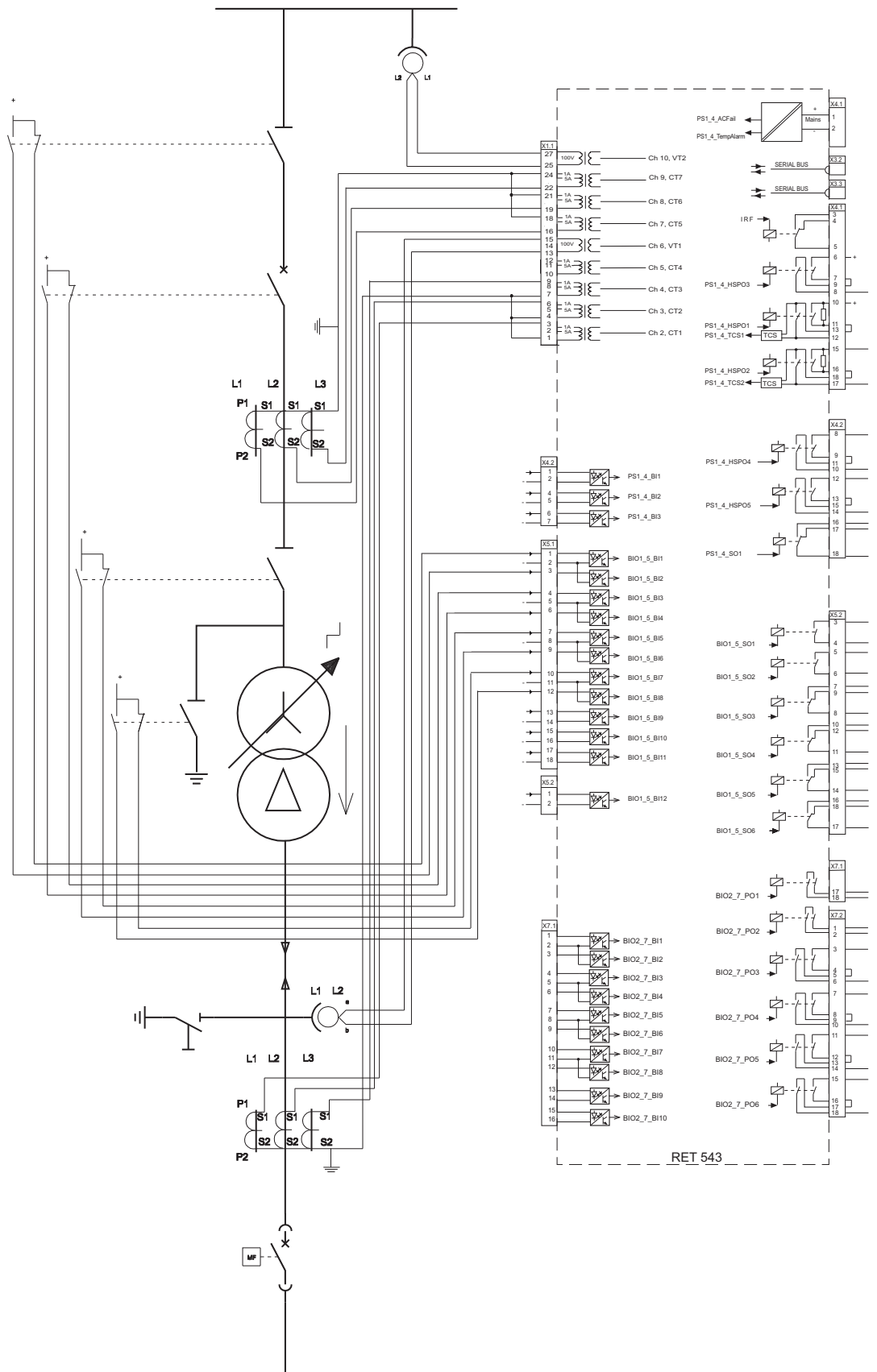

Fig. 3 Sample connection diagram of RET 543

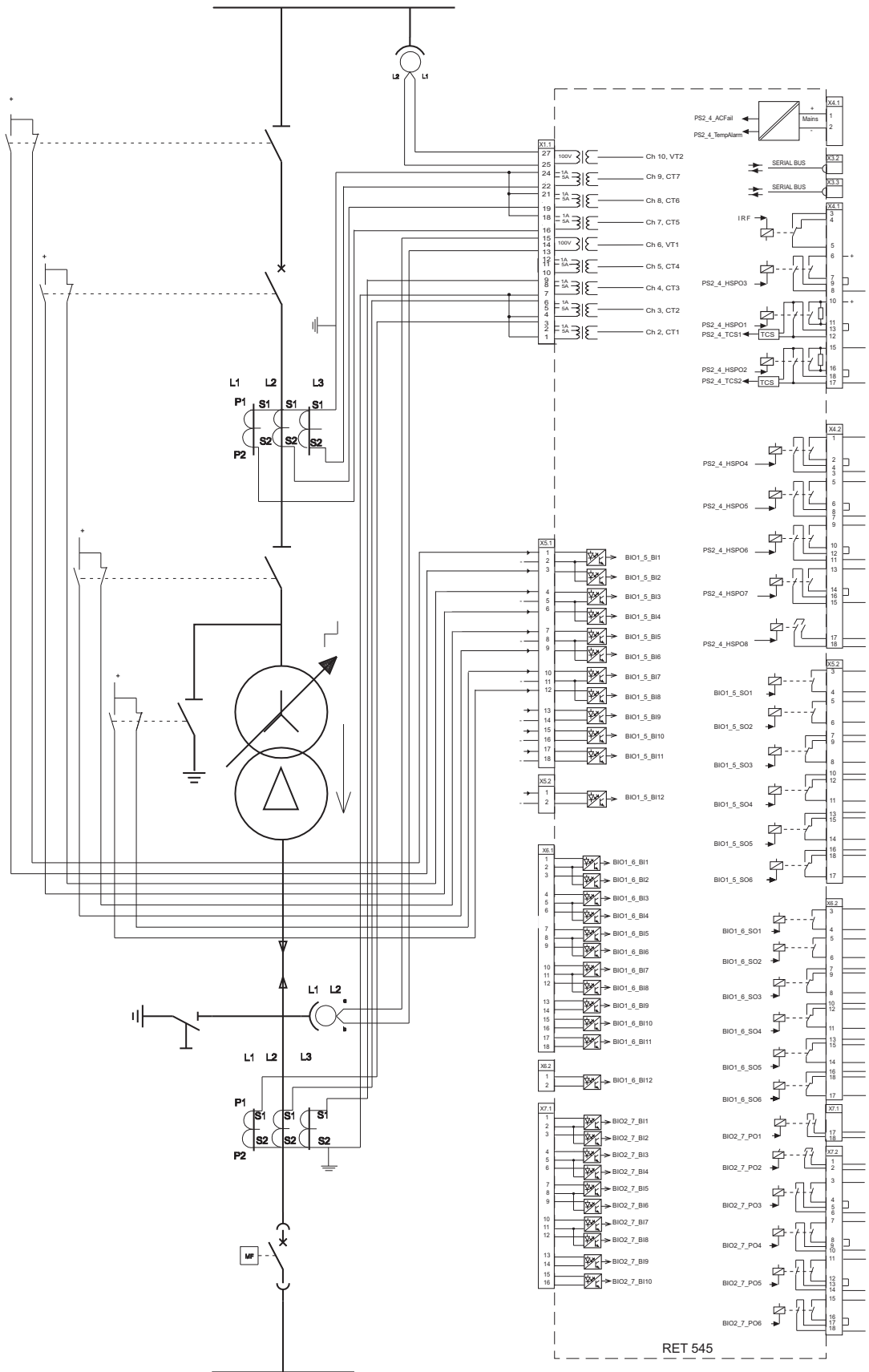

Fig. 4 Sample connection diagram of RET 545

CD545_b

Technical data

Table 1: General functions available for the RET 54_

Function	Description
INDRESET	Resetting of operation indicators, latched output signals, registers and waveforms i.e. the disturbance recorder
MMIWAKE	Activation of HMI backlight
SWGRP1	Switchgroup SWGRP1
SWGRP2	Switchgroup SWGRP2
SWGRP3	Switchgroup SWGRP3
.....	
SWGRP20	Switchgroup SWGRP20

Table 2: Standard functions available for the RET 54_

Function	Description
ABS	Absolute value
ACOS	Principal arc cosine
ADD	Extensible adder
AND	Extensible AND connection
ASIN	Principal arc sine
ATAN	Principal arc tangent
BCD2INT	Type conversion from BCD coded input to SINT (Tap changer)
BITGET	Get one bit
BITSET	Set one bit
BOOL_TO_*	Type conversion from BOOL to WORD / USINT / UINT / UDINT / SINT / REAL / INT / DWORD / DINT / BYTE
BOOL2INT	Type conversion from BOOL inputs to INT output
BYTE_TO_*	Type conversion from BYTE to WORD / DWORD
COMH	Hysteresis comparator
COS	Cosine in radians
CTD	Down-counter
CTUD	Up-down counter
CTU	Up-counter
DATE_TO_UDINT	Type conversion from DATE to UDINT
DINT_TO_*	Type conversion from DINT to SINT / REAL / INT
DIV	Divider
DWORD_TO_*	Type conversion from DWORD to WORD / BYTE
EQ	Extensible comparison to equal
EXP	Natural exponential
EXPT	Exponentiation
F_TRIG	Falling edge detector
GE	Extensible comparison to greater or equal
GRAY2INT	Type conversion from GRAY coded input to SINT (Tap changer)
GT	Extensible comparison to greater
INT_TO_*	Type conversion from INT to REAL / DINT
INT2BOOL	Type conversion from INT input to BOOL outputs
LE	Extensible comparison to less or equal
LIMIT	Limitation
LN	Natural logarithm
LOG	Logarithm base 10
LT	Extensible comparison to less
MAX	Extensible maximum
MIN	Extensible minimum
MOD	Modulo
MOVE	Move

Table 2: Standard functions available for the RET 54_

Function	Description
MUL	Extensible multiplier
MUX	Extensible multiplexer
NAT2INT	Type conversion from natural binary coded input to SINT (Tap changer)
NE	Comparison to greater or less
NOT	Complement
OR	Extensible OR connection
R_TRIG	Rising edge detector
REAL_TO_*	Type conversion from REAL to USINT / UINT / UDINT / SINT / INT / DINT
ROL	Rotate to left
ROR	Rotate to right
RS	Reset dominant bistable function block
RS_D	Reset dominant bistable function block with data input
SEL	Binary selection
SHL	Bit-shift to left
SHR	Bit-shift to right
SIN	Sine in radians
SINT_TO_*	Type conversion from SINT to REAL / INT / DINT
SUB	Subtractor
SQRT	Square root
SR	Set dominant bistable function block
XOR	Extensible exclusive OR connection
TAN	Tangent in radians
TIME_TO_*	Type conversion from TIME to UDINT / TOD / REAL
TOD_TO_*	Type conversion from TOD to UDINT / TIME / REAL
TOF	Off-delay timer
TON	On-delay timer
TP	Pulse
TRUNC_REAL_TO*	Truncation toward zero from REAL to DINT / INT / SINT / UDINT / UINT / USINT
UDINT_TO_*	Type conversion from UDINT to USINT / UINT / REAL
UINT_TO_*	Type conversion from UINT to USINT / UDINT / REAL / BOOL
USINT_TO_*	Type conversion from USINT to UINT / UDINT / REAL
WORD_TO_*	Type conversion from WORD to DWORD / BYTE

Table 3: Conditioning monitoring functions available for the RET 54_

Function	Description
CMBWEAR1	Circuit-breaker electric wear 1
CMBWEAR2	Circuit-breaker electric wear 2
CMCU3	Supervision function of the energizing current input circuit
CMGAS1	Gas pressure monitoring
CMGAS3	Three-pole gas pressure monitoring
CMSCHED	Scheduled maintenance
CMSPRC1	Spring charging control 1
CMTCS1	Trip circuit supervision 1
CMTCS2	Trip circuit supervision 2
CMTIME1	Operate time counter 1 for the operate time used (e.g. motors)
CMTIME2	Operate time counter 2 for the operate time used (e.g. motors)
CMTRAV1	Breaker travel time 1
CMVO3	Supervision function of the energizing voltage input circuit

Table 4: Control functions available for the RET 54_

Function	Description
CO3DC1	Three-state disconnecter 1 with indication
CO3DC2	Three-state disconnecter 2 with indication
COCB1	Circuit breaker 1 control with indication
COCB2	Circuit breaker 2 control with indication
COCBDIR	Direct open for CBs via HMI
CODC1	Disconnecter 1 control with indication
CODC2	Disconnecter 2 control with indication
CODC3	Disconnecter 3 control with indication
CODC4	Disconnecter 4 control with indication
CODC5	Disconnecter 5 control with indication
COIND1	Switching device 1 indication
COIND2	Switching device 2 indication
COIND3	Switching device 3 indication
COIND4	Switching device 4 indication
COIND5	Switching device 5 indication
COIND6	Switching device 6 indication
COIND7	Switching device 7 indication
COIND8	Switching device 8 indication
COLOCAT	Logic-controlled control position selector
COLTC	On-load tap changer controller (voltage regulator)
COSW1	On/off switch 1
COSW2	On/off switch 2
COSW3	On/off switch 3
COSW4	On/off switch 4
MMIALAR1	Alarm channel 1, LED indicator
MMIALAR2	Alarm channel 2, LED indicator
MMIALAR3	Alarm channel 3, LED indicator
MMIALAR4	Alarm channel 4, LED indicator
MMIALAR5	Alarm channel 5, LED indicator
MMIALAR6	Alarm channel 6, LED indicator
MMIALAR7	Alarm channel 7, LED indicator
MMIALAR8	Alarm channel 8, LED indicator
MMIDATA1	MIMIC data monitoring point 1
MMIDATA2	MIMIC data monitoring point 2
MMIDATA3	MIMIC data monitoring point 3
MMIDATA4	MIMIC data monitoring point 4
MMIDATA5	MIMIC data monitoring point 5

Table 5: On-load tap changer controller function block

On load tap changer control function (voltage regulator), COLTC	
Reference voltage	0.000 ... 2.000 xUn
Delay time for the 1st control pulse	1.0 ... 300.0 s
Delay time for the 2nd control pulse	1.0 ... 300.0 s
Resistive line-drop compens. factor (Ur)	0.0 ... 25.0 %Un
Reactive line-drop compens. factor (Ux)	0.0 ... 25.0 %Un
Load phase angle (in NRP mode)	-89 ... +89 deg
Stability factor in parallel operation	0.0 ... 70.0 %Un
Operation mode	Not in use Manual Automatic single Automatic master Automatic follower Negative Reactance Principle Minimizing Circulating Current Controlled via op.mode inputs
Delay mode	Definite time Inverse time
Raise and lower pulse duration	0.5 ... 10.0 s
Bandwith	0.60 ... 9.00 %Un
Overcurrent blocking limit	0.10 ... 5.00 xIn
Undervoltage blocking limit	0.10 ... 1.20 xUn
Overvoltage blocking limit	0.80 ... 1.60 xUn
High circ. current blocking limit	0.10 ... 5.00 xIn
Max limit for LDC term	0.00 ... 2.00 xUn
Reduce Set Voltage step	0.00 ... 9.00 %Un
Max volt tap	-36 ... 36
Min volt tap	-36 ... 36
Max parallel trafos in MCC mode	4
Operation accuracies	
- voltage measurement:	Depends on the frequency of the voltage measured: f/fn = 0.95 ... 1.05: ±1.0% of the set value or ±0.01xUn
- operation time DT mode:	±1% of the set value or ±250 ms
- operation time IDMT mode:	250ms and an inaccuracy which occurs when voltage varies ±0.5%
- lower and raise output pulse duration:	±100 ms
Reset ratio (hysteresis)	20% of the set Bandwith

Table 6: Measurement function blocks

General measurement/ analog input on RTD/analog module, MEAI1...8	
The general measurement function blocks can be used to measure general purpose dc or ac voltage signals with a sensor input. They also include a REAL type input which can be used to monitor any internal REAL type IEC 61131-3 based signal, e.g. input data from the RTD/analog module.	
GE1...3 (V dc/ac)	-10000.00000...10000.00000
General REAL type input	-10000.00000...10000.00000
Analog output on RTD/analog module, MEO1...4	
The analog output function blocks handle the scaling of any internal REAL type IEC 61131-3 based signal to fit a selectable 0...20 mA or 4...20 mA range for use with the outputs on the RTD/analog module.	
General REAL type input	-10000.00000...10000.00000
Neutral current measurement, MECU1A and MECU1B	
Io (A)	0.0...20000.0 A
Io (%)	0.0...80.0% In

Three-phase current measurement, MECU3A and MECU3B	
IL1	0.0...20000.0 A
IL2	0.0...20000.0 A
IL3	0.0...20000.0 A
IL1	0.0...1000.0% In
IL2	0.0...1000.0% In
IL3	0.0...1000.0% In
IL1 demand	0.0...20000.0 A
IL2 demand	0.0...20000.0 A
IL3 demand	0.0...20000.0 A
IL1 demand	0.0...1000.0% In
IL2 demand	0.0...1000.0% In
IL3 demand	0.0...1000.0% In

Transient disturbance recorder for 16 analog channels, MEDREC16																	
<p>The transient disturbance recorder MEDREC16 is used for recording the current and voltage waveforms, as well as the status data of internal IEC 61131-3 based logic signals and digital inputs connected to the transformer terminals. Maximum 16 analog inputs and 16 logic signal inputs are available. One fundamental cycle contains 40 samples.</p>																	
Operation mode	Saturation Overwrite Extension																
Pre-trg time	0...100%																
Over limit ILx	0.00...40.00 x In																
Over limit Io	0.00...40.00 x In																
Over limit Iob	0.00...40.00 x In																
Over limit Uo	0.00...2.00 x Un																
Over limit Ux	0.00...2.00 x Un																
Over limit Uxy	0.00...2.00 x Un																
Over limit U12b	0.00...2.00 x Un																
Over limit ILxb	0.00...40.00 x In																
Under limit Ux	0.00...2.00 x Un																
Under limit Uxy	0.00...2.00 x Un																
AI filter time	0.000...60.000 s																
<p>The recording can be triggered by any (or several) of the alternatives listed below:</p> <ul style="list-style-type: none"> triggering on the rising or falling edge of any (or several) of the digital inputs triggering on overcurrent, overvoltage or undervoltage manual triggering via the menu or with the push-button F on the front panel (if configured) triggering via serial communication periodic triggering <p>The recording length depends on the number of recordings and inputs used. For example, the following combination of recording length, number of recordings and number of inputs is available at 50 Hz (60 Hz):</p>																	
# recordings \ # inputs	<table border="1"> <thead> <tr> <th></th> <th>1</th> <th>3</th> <th>10</th> </tr> </thead> <tbody> <tr> <td>1</td> <td>1163 cyc. 23.3 s (19.4 s)</td> <td>412 cyc. 8.2 s (6.9 s)</td> <td>126 cyc. 2.5 s (2.1 s)</td> </tr> <tr> <td>5</td> <td>232 cyc. 4.6 s (3.9 s)</td> <td>82 cyc. 1.6 s (1.4 s)</td> <td>25 cyc. 0.5 s (0.4 s)</td> </tr> <tr> <td>10</td> <td>115 cyc. 2.3 s (1.9 s)</td> <td>41 cyc. 0.8 s (0.7 s)</td> <td>12 cyc. 0.24 s (0.2 s)</td> </tr> </tbody> </table>		1	3	10	1	1163 cyc. 23.3 s (19.4 s)	412 cyc. 8.2 s (6.9 s)	126 cyc. 2.5 s (2.1 s)	5	232 cyc. 4.6 s (3.9 s)	82 cyc. 1.6 s (1.4 s)	25 cyc. 0.5 s (0.4 s)	10	115 cyc. 2.3 s (1.9 s)	41 cyc. 0.8 s (0.7 s)	12 cyc. 0.24 s (0.2 s)
	1	3	10														
1	1163 cyc. 23.3 s (19.4 s)	412 cyc. 8.2 s (6.9 s)	126 cyc. 2.5 s (2.1 s)														
5	232 cyc. 4.6 s (3.9 s)	82 cyc. 1.6 s (1.4 s)	25 cyc. 0.5 s (0.4 s)														
10	115 cyc. 2.3 s (1.9 s)	41 cyc. 0.8 s (0.7 s)	12 cyc. 0.24 s (0.2 s)														

System frequency measurement, MEFR1	
Frequency	10.00...75.00 Hz
Average Freq.	10.00...75.00 Hz
Voltage U	0.0...2.0 x Un

Three-phase power and energy measurement, MEPE7	
P3 (kW)	-999999...999999 kW
Q3 (kvar)	-999999...999999 kvar
Power factor DPF	-1.00...1.00
Power factor PF	-1.00...1.00
P3 demand (kW)	-999999...999999 kW
Q3 demand (kvar)	-999999...999999 kvar
Energy kWh	0...9999999999 kWh
Reverse kWh	0...9999999999 kWh
Energy kvarh	0...9999999999 kvarh
Reverse kvarh	0...9999999999 kvarh

Residual voltage measurement, MEVO1A and MEVO1B	
Uo	0...150000 V
Uo	0.0...120.0% Un

Three-phase voltage measurement, MEVO3A and MEVO3B	
UL1_U12	0.00...999.99 kV
UL2_U23	0.00...999.99 kV
UL3_U31	0.00...999.99 kV
UL1_U12	0.00...2.00 x Un
UL2_U23	0.00...2.00 x Un
UL3_U31	0.00...2.00 x Un
UL1_U12 average	0.00...999.99 kV
UL2_U23 average	0.00...999.99 kV
UL3_U31 average	0.00...999.99 kV
UL1_U12 average	0.00...2.00 x Un
UL2_U23 average	0.00...2.00 x Un
UL3_U31 average	0.00...2.00 x Un

Table 7: Protection function blocks

Three-phase non-directional overcurrent protection, low-set stages, NOC3Low, 3I>, NOC3LowB,3I>	
Start current	0.10...5.00 x I _n
Operate time at DT mode	0.05...300.00 s
Time multiplier at IDMT mode	0.05...1.00
Operation mode	Not in use Definite time Extremely inverse Very inverse Normal inverse Long time inverse RI-type inverse RD-type inverse IEEE curves
Measuring mode	Peak-to-peak Fundamental frequency
Drop-off time of the operate time counter	0...1000 ms
Operation accuracy	Note! The values below apply when f/f _n = 0.95...1.05 ±2.5% of set value or ±0.01 x I _n
Start time:	
- Injected currents	>2.0 x start current:
- internal time	<32 ms
- total time	<40 ms
Reset time	40...1000 ms (depends on the minimum pulse width set for the trip output)
Reset ratio, typically	0.95
Retardation time	< 45 ms
Operate time accuracy at DT mode	±2% of set value or ±20 ms
Accuracy class index E at IDMT mode	Class index E = 5.0 or ±20 ms

Three-phase non-directional overcurrent protection, high-set stage, NOC3High, 3I>>, and instantaneous stage, NOC3Inst, 3I>>>	
Start current	0.10...40.00 x I _n
Operate time	0.05...300.00 s
Operation mode	Not in use Definite time Instantaneous
Measuring mode	Peak-to-peak Fundamental frequency
Drop-off time of the operate time counter	0...1000 ms
Operation accuracy	Note! The values below apply when f/f _n = 0.95...1.05 0.1...10 x I _n : ±2.5% of set value or ±0.01 x I _n 10...40 x I _n : ±5.0% of set value
Start time:	
- injected currents	>2.0 x start current:
- internal time	<32 ms
- total time	<40 ms
Reset time	40...1000 ms (depends on the minimum pulse width set for the trip output)
Reset ratio, typically	0.95
Retardation time	< 45 ms
Operate time accuracy at DT mode	±2% of set value or ±20 ms

Three-phase directional overcurrent function, low-set stage, DOC6Low, I>→	
Operation mode	Not in use Definite time Extremely inverse Very inverse Normal inverse Long-time inverse RI-type inverse RD-type inverse
Start current	0.05...40.00 x I _n
Operate time	0.05...300.00 s
Time multiplier	0.05...1.00
Basic angle φ _b	0...90°
Operation direction	Forward Reverse
Earth-fault protection	Disabled Enabled
Measuring mode	Phase-to-phase voltages, peak-to-peak measurement Phase-to-phase voltages, fundamental freq. measurement Phase-to-earth voltages, peak-to-peak measurement Phase-to-earth voltages, fundamental freq. measurement
Drop-off time of the operate time counter	0...1000 ms
Operation accuracy	Note! The values below apply when f/f _n = 0.95...1.05 0.1...10 x I _n : ±2.5% of set value or ±0.01 x I _n 10...40 x I _n : ±5.0% of set value ±2.5% of measured voltage or ±0.01 x U _n ±2°
Start time:	
- injected currents	>2.0 x start current:
- internal time	<42 ms
- total time	<50 ms
Reset time	40...1000 ms (depends on the minimum pulse width set for the trip output)
Reset ratio, typically	0.95
Retardation time	< 45 ms
Operate time accuracy at DT mode	±2% of set value or ±20 ms
Accuracy class index E at IDMT mode	Class index E = 5.0 or ±20 ms

Three-phase directional overcurrent function, high-set stage, DOC6High, I>>→, and instantaneous stage, DOC6Inst, I>>>→	
Operation mode	Not in use Definite time Instantaneous
Start current	0.05...40.00 x I _n
Operate time	0.05...300.00 s
Basic angle φ _b	0...90°
Operation direction	Forward Reverse
Earth-fault protection	Disabled Enabled
Non-directional operation (when the direction cannot be determined)	Disabled Enabled
Measuring mode	Phase-to-phase voltages, peak-to-peak measurement Phase-to-phase voltages, fundamental freq. measurement Phase-to-earth voltages, peak-to-peak measurement Phase-to-earth voltages, fundamental freq. measurement
Drop-off time of the operate time counter	0...1000 ms

Operation accuracy	Note! The values below apply when $f/f_n = 0.95...1.05$ 0.1...10 x I_n : $\pm 2.5\%$ of set value or $\pm 0.01 \times I_n$ 10...40 x I_n : $\pm 5.0\%$ of set value $\pm 2.5\%$ of measured voltage or $\pm 0.01 \times U_n$ $\pm 2^\circ$
Start time:	
- injected currents	>2.0 x start current:
- internal time	<42 ms
- total time	<50 ms
Reset time	40...1000 ms (depends on the minimum pulse width set for the trip output)
Reset ratio, typically	0.95
Retardation time	< 45 ms
Operate time accuracy at DT mode	$\pm 2\%$ of set value or ± 20 ms

Three-phase underimpedance protection, low-set stage UI6Low, Z<, and high-set stage UI6High, Z<<	
Z-setting	0.01...60.00 p.u.
Operate time	0.04...300.00 s
UI6High	Not in use; In use
Meas. signals (phase selection)	4 selections for ph-e voltages 7 selections for ph-ph voltages (depends on the signals available)
Measuring mode	Peak-to peak; Fund.freq.
Operation accuracy	Note! The values below apply when $f/f_n = 0.95...1.05$ $\pm 3.0\%$ of set value or ± 0.02 p.u.
Start time:	
- injected impedance	= 0.50 x Z-setting
- internal time	<42 ms
- total time	<50 ms
Reset time	70...1030 ms (depends on the minimum pulse width set for the TRIP output)
Reset ratio	Typ. 1.03
Retardation time	< 45 ms
Operate time accuracy	$\pm 2\%$ of set value or ± 20 ms

Stabilized and instantaneous differential protection for transformers, Diff6T, 3ΔI>, 3ΔI>>	
Basic setting; the lowest ratio of differential and nominal current to cause a trip	5...50%
Starting ratio; slope of the 2nd line of the operating characteristics	10...50%
Turn-point 1; turnpoint between the 1st and 2nd line of the operating characteristics	0.5 x I_n
Turn-point 2; turnpoint between the 2nd and 3rd line of the operating characteristics	1.0...3.0 x I_n
Tripping value of the instantaneous stage	5...30 x I_n
Operation accuracy	Note! The values below apply when $f/f_n = 0.95...1.05$ Phase difference measurement: $\pm 4^\circ$ Stabilized stage: $\pm 4\%$ of set value or $\pm 2\% \times I_n$ Instantaneous stage: $\pm 4\%$ of set value or $\pm 2\% \times I_n$
Trip time:	
- Injected currents	>2.0 x operating current
- internal time	<35 ms
- total time	<45 ms
Reset time	60...1020 ms (depends on the minimum pulse width set for the trip output)
Reset ratio, typically	0.98
Retardation time	< 40 ms

Non-directional earth-fault protection, low-set stage, NEF1Low, $I_0 >$	
Start current	1.0...100.0% of I_n
Operate time at DT mode	0.05...300.00 s
Time multiplier at IDMT mode	0.05...1.00
Operation mode	Not in use Definite time Extremely inverse Very inverse Normal inverse Long time inverse RI-type inverse RD-type inverse IEEE curves
Measuring mode	Peak-to-peak Fundamental frequency
Drop-off time of the operate time counter	0...1000 ms
Operation accuracy	Note! The values below apply when $f/f_n = 0.95...1.05$ $\pm 2.5\%$ of set value + $0.0005 \times I_n$
Start time:	
- Injected currents	>2.0 x start current:
- internal time	<32 ms
- total time	<40 ms
Reset time	40...1000 ms (depends on the minimum pulse width set for the trip output)
Reset ratio, typically	0.95
Retardation time	<45 ms
Operate time accuracy at DT mode	$\pm 2\%$ of set value or ± 20 ms
Accuracy class index E at IDMT mode	Class index E = 5.0 or ± 20 ms

Non-directional earth-fault protection, high-set stage, NEF1High, $I_0 >>$, and instantaneous stage, NEF1Inst, $I_0 >>>$	
Start current	0.10...12.00 x I_n
Operate time	0.05...300.00 s
Operation mode	Not in use Definite time Instantaneous
Measuring mode	Peak-to-peak Fundamental frequency
Drop-off time of the operate time counter	0...1000 ms
Operation accuracy	Note! The values below apply when $f/f_n = 0.95...1.05$ $\pm 2.5\%$ of set value or $+ 0.01 \times I_n$
Start time:	
- Injected currents	>2.0 x start current
- internal time	<32 ms
- total time	<40 ms
Reset time	40...1000 ms (depends on the minimum pulse width set for the trip output)
Reset ratio, typically	0.95
Retardation time	< 45 ms
Operate time accuracy at DT mode	$\pm 2\%$ of set value or ± 20 ms

Directional earth-fault protection, low-set stage, DEF2Low, $I_0 \rightarrow$	
Start current	1.0...25.0% of I_n
Start voltage	2.0...100.0% of U_n
Operate time at DT mode	0.1...300.0 s
Time multiplier at IDMT mode	0.05...1.00
Operation mode	Not in use Definite time Extremely inverse Very inverse Normal inverse Long time inverse
Operation criteria	Basic angle & U_0 Basic angle $I_0 \sin / \cos$ & U_0 $I_0 \sin / \cos$ Non-directional I_0 Non-directional U_0
Operation direction	Forward Reverse
Basic angle φ_b	-90° -60° -30° 0°
Operation characteristic	$I_0 \sin(\varphi)$ $I_0 \cos(\varphi)$
Intermittent E/F	Not active Active
Measuring mode	Peak-to-peak Fundamental frequency
Drop-off time of the operate time counter	0...1000 ms
Operation accuracy	Note! The values below apply when $f/f_n = 0.95...1.05$ $\pm 2.5\%$ of set value + $0.0005 \times I_n$ $\pm 2.5\%$ of set value or + $0.01 \times U_n$ Phase angle $\pm 2^\circ$
Start time:	
- Injected neutral current and residual voltage	>2.0 x start current and residual voltage >2.0 x start voltage
- internal time	<72 ms
- total time	< 80 ms
Reset time	40...1000 ms (depends on the minimum pulse width set for the trip output)
Reset ratio, typically	0.95
Retardation time	< 50 ms
Operate time accuracy at DT mode	$\pm 2\%$ of set value or ± 20 ms
Accuracy class index E at IDMT mode	Class index E = 5.0 or ± 20 ms

Directional earth-fault protection, high-set stage, DEF2High, $I_0 >> \rightarrow$, and instantaneous stage, DEF2Inst, $I_0 >>> \rightarrow$	
Start current	1.0...200.0% of I_n
Start voltage	2.0...100.0% of U_n
Operate time	0.1...300.0 s
Operation mode	Not in use Definite time Instantaneous
Operation criteria	Basic angle & U_0 Basic angle $I_0 \sin / \cos$ & U_0 $I_0 \sin / \cos$ Non-directional I_0 Non-directional U_0
Operation direction	Forward Reverse
Basic angle φ_b	-90° -60° -30° 0°
Operation characteristic	$I_0 \sin(\varphi)$ $I_0 \cos(\varphi)$
Intermittent E/F	Not active Active
Measuring mode	Peak-to-peak Fundamental frequency
Drop-off time of the operate time counter	0...1000 ms
Operation accuracy	Note! The values below apply when $f/f_n = 0.95...1.05$ $\pm 2.5\%$ of set value + $0.0005 \times I_n$ $\pm 2.5\%$ of set value or + $0.01 \times U_n$ Phase angle $\pm 2^\circ$
Start time, injected neutral current and residual voltage	Injected neutral current $> 2.0 \times$ start current and residual voltage $> 2.0 \times$ start voltage
- internal time	< 72 ms
- total time	< 80 ms
Reset time	40...1000 ms (depends on the minimum pulse width set for the trip output)
Reset ratio, typically	0.95
Retardation time	< 50 ms
Operate time accuracy at DT mode	$\pm 2\%$ of set value or ± 20 ms

High-impedance based restricted earth-fault protection, REF1A, $\Delta I_0 >$	
Basic setting; the lowest ratio of differential and nominal current to cause a trip	0.5...50%
Operation accuracy	Note! The values below apply when $f/f_n = 0.95...1.05$ $\pm 2.5\%$ of set value or $\pm 0.004 \times I_n$
Trip time	$> 2.0 \times$ operating current: < 20 ms
- injected currents	< 30 ms
- internal time	
- total time	
Reset time	60...1020 ms (depends on the minimum pulse width set for the trip output)
Reset ratio	0.80...0.98
Retardation time	This function block cannot be retarded but trips once the current exceeds the operate value

Stabilized restricted earth-fault protection, REF4A, ΔI_0 and REF4B, ΔI_0	
Basic setting	0.5...50%
Operate time	0.04...300.00 s
Ratio I_{2f}/I_{1f}	10...50 %
2nd harmonic blocking	Not in use / In use
Operation accuracy of differential current measurement	Note! The values below apply when $f/f_n = 0.95...1.05$ $\pm 4\%$ of set value or $\pm 0.02 \times I_n$
Operation accuracy of phase angle measurement	$\pm 2\%$
Start time:	
- injected currents	$\geq 2.0 \times$ operating current:
- internal time	<30 ms
- total time	<40 ms
Reset time	40...1000 ms (depends on the minimum pulse width set for the trip output)
Reset ratio, typically	0.98 (0.90...0.98)
Retardation time (Total retardation time when the current drops below the start value)	<50 ms
Operation time accuracy at definite time mode	$\pm 2\%$ of set value or ± 20 ms

Residual overvoltage protection, low-set stage, ROV1Low, U_0	
Start voltage	2.0...20.0% of U_n
Operate time	0.05...300.00 s
Operation mode	Not in use Definite time
Measuring mode	Peak-to-peak Fundamental frequency
Operation accuracy	Note! The values below apply when $f/f_n = 0.95...1.05$ $\pm 2.5\%$ of set value or $\pm 0.01 \times U_n$
Start time:	
- injected voltages	$> 2 \times$ start voltage:
- internal time	<32 ms
- total time	<40 ms
Reset time	40...1000 ms (depends on the minimum pulse width set for the trip output)
Reset ratio, typically	0.95
Retardation time	Total time for blocking: < 25 ms Total time when voltage drops below start value: < 50 ms
Operate time accuracy at DT mode	$\pm 2\%$ of set value or ± 20 ms

Residual overvoltage protection, high-set stage, ROV1High, $U_0 >>$, and instantaneous stage, ROV1Inst, $U_0 >>>$	
Start voltage	2.0...80.0% of U_n
Operate time	0.05...300.00 s
Operation mode	Not in use
Measuring mode	Definite time
	Peak-to-peak
	Fundamental frequency
Operation accuracy	Note! The values below apply when $f/f_n = 0.95...1.05$ $\pm 2.5\%$ of set value or $\pm 0.01 \times U_n$
Start time	
- injected voltages	$> 2 \times$ start voltage
- internal time	< 32 ms
- total time	< 40 ms
Reset time	40...1000 ms (depends on the minimum pulse width set for the trip output)
Reset ratio, typically	0.95
Retardation time	Total time for blocking: < 25 ms Total time when voltage drops below start value: < 50 ms
Operate time accuracy at DT mode	$\pm 2\%$ of set value or ± 20 ms

Three-phase thermal overload protection for motors, generators and transformers, TOL3Dev, 3 	
BASIC SETTINGS: Starting current of the motor Max. starting time permitted for the motor Number of starts allowed from cold state Type of device to be protected Trip temperature Prior alarm temperature Restart inhibit (temperature limit for successful restarting) Ambient temperature Cooling time-constant Heating time-constant for generator or transformer	0.10...10.00 x I _n 0.1...120.0 s 1...3 Motor; through-ventilated, rated power < 1500 kW Motor; through-ventilated, rated power > 1500 kW Motor; surface cooling, rated power < 500 kW Motor; surface cooling, rated power > 500 kW Generator; hydro or small air-cooled turbine generators Generator; large turbine generators Transformer 80.0...120.0% 40.0...100.0% 40.0...100.0% -50.0...100.0°C 1.0...10.0 x time constant 1...999 min
ADVANCED SETTINGS: Short time-constant for stator Long time-constant for stator Weighting factor of the short time-constant for stator Temperature rise of stator at rated current Maximum temperature of stator Short time-constant for rotor Long time-constant for rotor Weighting factor of the short time-constant for rotor Temperature rise of rotor at rated current Maximum temperature of rotor	0.0...999.0 min 0.0...999.0 min 0.00...1.00 0.0...350.0 °C 0.0...350.0 °C 0.0...999.0 min 0.0...999.0 min 0.00...1.00 0.0...350.0 °C 0.0...350.0 °C
Operation mode (principle of ambient temperature compensation) Waiting time for a successful restart (Read-only parameter) Estimated time to the trip (Read-only parameter)	Not in use No sensors; the set ambient temperature 1 sensor used 2 sensors used 0...86400 s 0...86400 s
Operation accuracy Reset ratio: - trip - start - restart	Note! The values below apply when f/f _n = 0.95...1.05 ±1.0%, I = 0.1...10.0 x I _n (Calculated temp. rise - 0.1) / Trip temperature (Calculated temp. rise - 0.1) / Prior alarm temperature (Calculated temp. rise - 0.1) / Restart inhibit temperature limit

Negative phase-sequence protection, low-set stage, NPS3Low, I₂>, and high-set stage, NPS3High, I₂>>	
Operation mode	Not in use Definite time Inverse time
Start value of negative-sequence current I ₂	0.01...0.50 x I _n
Operate time	0.1...120.0 s
Operating characteristic constant K (corresponds to the machine constant, equal to the I ₂ ² t constant of the machine as stated by machine manufacturer)	5.0...100.0
Definite start time at inverse-time mode	0.1...60.0 s
Definite minimum operate time	0.1...120.0 s
Maximum operate time	500...10000 s
Cooling time of the machine	5...10000 s
Number of phases to be measured	2 or 3
Rotation direction	Forward Reverse
Drop-off time of the operate time counter	0...1000 ms
Operation accuracy	Note! The values below apply when f/fn = 0.95...1.05 ±2.5% of set value or ±0.01 x I _n
Start time:	
- injected negative-seq. current	= 2.00 x start value
- internal time	<32 ms
- total time	<40 ms
Reset time	70...1030 ms (depends on the minimum pulse width set for the trip output)
Reset ratio, typically	0.96
Retardation time	<45 ms
Operate time accuracy at DT mode	±2% of set value or ±20 ms
Accuracy class index E at IDMT mode, typically	±2% of the calculated ideal operate time or ±20 ms

Three-phase overvoltage protection, low-set stage, OV3Low, 3U>	
Start voltage	0.10...1.60 x U _n
Operate time	0.05...300.0 s
Time multiplier	0.05...1.00
Operation mode	Not in use Definite time A curve B curve
Measuring mode	Phase-to-phase voltages; peak-to-peak measurement Phase-to-phase voltages; fundamental freq. measurement Phase-to-earth voltages; fundamental freq. measurement
Operation hysteresis	1.0...5.0%
Operation accuracy	Note! The values below apply when f/fn = 0.95...1.05 ±2.5% of set value
Start time:	
-injected voltages	= 1.1 x start voltage
- internal time	<42 ms
- total time	<50 ms
Reset time	40...1000 ms (depends on the minimum pulse width set for the trip output)
Reset ratio	0.96 (range 0.95...0.99)
Retardation time	< 50 ms
Operate time accuracy at DT mode	±2% of set value or ±20 ms
Accuracy class index E at IDMT mode, typically	±20 ms

Three-phase overvoltage protection, high-set stage, OV3High, 3U>>	
Start voltage	0.10...1.60 x Un
Operate time	0.05...300.0 s
Operation mode	Not in use Definite time
Measuring mode	Phase-to-phase voltages; peak-to-peak measurement Phase-to-phase voltages; fundamental freq. measurement Phase-to-earth voltages; fundamental freq. measurement
Operation hysteresis	1.0...5.0%
Operation accuracy	Note! The values below apply when $f/f_n = 0.95...1.05$ $\pm 2.5\%$ of set value
Start time:	
- injected voltages	= 1.1 x start voltage
- internal time	<42 ms
- total time	<50 ms
Reset time	40...1000 ms (depends on the minimum pulse width set for the trip output)
Reset ratio	0.96 (range 0.95...0.99)
Retardation time	< 50 ms
Operate time accuracy at DT mode	$\pm 2\%$ of set value or ± 20 ms

Three-phase undervoltage protection, low-set stage, UV3Low, 3U<	
Start voltage	0.10...1.20 x Un
Operate time	0.1...300.0 s
Time multiplier	0.1...1.0
Operation mode	Not in use Definite time C curve
Measuring mode	Phase-to-phase voltages; peak-to-peak measurement Phase-to-phase voltages; fundamental freq. measurement Phase-to-earth voltages; fundamental freq. measurement
Operation hysteresis	1.0...5.0%
Operation accuracy	Note! The values below apply when $f/f_n = 0.95...1.05$ $\pm 2.5\%$ of set value or $\pm 0.01 \times U_n$
Start time:	
- injected voltages	<0.5 x start voltage:
- internal time	<32 ms
- total time	<40 ms
Reset time	40...1000 ms (depends on the minimum pulse width set for the trip output)
Reset ratio	1.04 (range 1.01...1.05)
Retardation time	< 60 ms
Operate time accuracy at DT mode	$\pm 2.5\%$ of set value
Accuracy class index E at IDMT mode, typically	± 35 ms

Three-phase undervoltage protection, high-set stage, UV3High, 3U<<	
Start voltage	0.10...1.20 x Un
Operate time	0.1...300.0 s
Operation mode	Not in use Definite time
Measuring mode	Phase-to-phase voltages; peak-to-peak measurement Phase-to-phase voltages; fundamental freq. measurement Phase-to-earth voltages; fundamental freq. measurement
Operation hysteresis	1.0...5.0%
Operation accuracy	Note! The values below apply when $f/f_n = 0.95...1.05$ $\pm 2.5\%$ of set value or $\pm 0.01 \times U_n$
Start time:	
- injected voltages	<0.5 x start voltage:
- internal time	<32 ms
- total time	<40 ms
Reset time	40...1000 ms (depends on the minimum pulse width set for the trip output)
Reset ratio	1.04 (range 1.01...1.05)
Retardation time	<60 ms
Operate time accuracy at DT mode	$\pm 2.5\%$ of set value

Phase-sequence voltage protection, PSV3St1 and PSV3St2, U_{1<}, U_{2>}, U_{1>}	
Start value U2>	0.01...1.00 x Un
Start value U1<	0.01...1.20 x Un
Start value U1>	0.80...1.60 x Un
Operate time U2>	0.04...60.00 s
Operate time U1<	0.04...60.00 s
Operate time U1>	0.04...60.00 s
Operation mode	Not in use; U1< & U2> & U1>; U1< & U2>; U2> & U1>; U1< & U1>; U2>; U1<; U1>
Rotation direction selection	Forward; Reverse; Input ROT_DIR
Operation accuracy	Note! The values below apply when $f/f_n = 0.95...1.05$ $\pm 2.5\%$ of set value or $\pm 0.01 \times U_n$
Trip time, U2> operation:	
- Injected negative-sequence voltage	= 1.1 x start value
- internal time	<42 ms
- total time	<50 ms
Trip time, U1< operation:	
- injected positive-sequence voltage	= 0.50 x start value
- internal time	<32 ms
- total time	<40 ms
Trip time, U1> operation:	
- Injected positive-sequence voltage	= 1.1 x start value
- internal time	<42 ms
- total time	<50 ms
Reset time	70...1030 ms (depends on the minimum pulse width set for the TRIP output)
Reset ratio, typically	U2> operation: 0.96 U1< operation: 1.04 U1> operation: 0.99
Retardation time	<45 ms (for all operations)
Operate time accuracy	$\pm 2\%$ of set value or ± 20 ms

Underfrequency or overfrequency protection, 5 stages, Freq1St1... Freq1St5, f</f>, df/dt	
Operation mode	Not in use f</f> 1 timer f</f> 2 timers f</f> OR df/dt> f</f> AND df/dt> f</f> OR df/dt< f</f> AND df/dt<
Undervoltage limit for blocking	0.30...0.90 x Un
Start value for under-/overfrequency prot.	25.00...75.00 Hz
Operate time for under-/overfrequency prot.	0.10...120.00 s
Start value for df/dt protection	0.2...10.0 Hz/s
Operate time for df/dt protection	0.12...120.00 s
Operation accuracy	Under-/overfrequency (f</f>): ±10 mHz
- Frequency rate of change (df/dt):	
- real df/dt	<±5 Hz/s: ±100 mHz/s
- real df/dt	<±15 Hz/s: ±2.0% of real df/dt
- Undervoltage blocking	±1.0% of set value
Start time:	
- total start times at fn = 50 Hz:	
- frequency measurement	<100 ms
- df/dt measurement	<120 ms
Reset time	140...1000 ms (depends on the minimum pulse width set for the trip output)
Operate time accuracy	±2% of set value or ±30 ms

Overexcitation protection, low-set stage, OE1Low, U/f>, and high-set stage, OE1High, U/f>>	
U/f start (DT mode)	1.00...2.00 x U/f
U/f start (IDMT mode)	1.00...2.00 x U/f
U max cont.	0.80...1.60 x Un
Operate time	0.10...600.00 s
k	0.1...100.0
Maximum time	500...10000 s
Constant delay	0.1...120.0 s
Cooling time	5...10000 s
Operation mode	Not in use; Definite time; Curve#1; Curve#2
Operation accuracies	20...40 Hz: ±4% of set value; 40...80 Hz: ±2% of set value
Start time:	
- Injected U/f	>2.0 x Un/fn
- internal time	<60 ms,
- total time	<70 ms
Reset time	100...1060 ms (depends on the set minimum pulse width for the TRIP output)
Reset ratio:	
- 20...40 Hz	typ. 0.99
- 40...80 Hz	typ 0.97
Retardation time	<105 ms
Operate time accuracy at definite-time mode	20...80 Hz: ±4% of set value or ±40 ms
Operate time accuracy at inverse-time modes	±100 ms or the accuracy appearing when the measured voltage varies ±1.0%

Three-phase transformer inrush and motor start-up current detector Inrush3, 3I _{2f} >	
Ratio I _{2f} /I _{1f} > Start current Operation mode	5...50% 0.10...5.00 x I _n Not in use Inrush mode Start-up mode
Operation accuracy: - current measurement - ratio I _{2f} /I _{1f} measurement Start time: - internal time - total time	Note! The values below apply when f/f _n = 0.95...1.05 ±2.5% of set value or ±0.01 x I _n ±5.0% of set value <32 ms <40 ms

Fuse failure supervision, FuseFail, FUSEF	
Ratio U ₂ /U ₁ > Ratio I ₂ /I ₁ <	10...50% 10...50%
Operation accuracy: - when f/f _n = 0.98...1.02: - when f/f _n = 0.95...1.05: - injected negative-sequence voltage BSOUT activation time: - f/f _n =0.98...1.02 Reset time Reset ratio: - for Ratio U ₂ /U ₁ > - for Ratio I ₂ /I ₁ <	±2.0 percentage units (of settings Ratio U ₂ /U ₁ > and Ratio I ₂ /I ₁ <) ±4.0 percentage units (of settings Ratio U ₂ /U ₁ > and Ratio I ₂ /I ₁ <) = 2.00 x Ratio U ₂ /U ₁ > < 35 ms (within the same task and when the task interval is 10 ms) 20 ms (within the same task) 0.8...0.96 1.04...1.2

Table 8: Energizing inputs

Rated frequency		50.0/60.0 Hz	
Current inputs	rated current	1 A/5 A	
	thermal withstand capability	continuously	4 A/20 A
		for 1 s	100 A/500 A
	dynamic current withstand, half-wave value	250 A/1250 A	
input impedance	<100 mΩ/<20 mΩ		
Voltage inputs	rated voltage (parameterization)	100 V/110 V/115 V/120 V	
	voltage withstand, continuously	2 x U _n (240 V)	
	burden at rated voltage	<0.5 VA	

Table 9: Auxiliary power supplies

Type	PS1/240V (RET 541, RET 543)	PS2/240V (RET 545 only)	External display module	PS1/48V (RET 541, RET 543)	PS2/48V (RET 545 only)
Input voltage, ac	110/120/220/240 V			-	
Input voltage, dc	110/125/220 V			24/48/60 V	
Voltage variation	ac 85...110%, dc 80...120% of rated value			dc 80...120% of rated value	
Burden	<50 W				
Ripple in dc auxiliary voltage	max. 12% of the dc value				
Interruption time in auxiliary dc voltage without resetting	<40 ms, 110 V and <100 ms, 200 V			<60 ms, 48 V and <100 ms, 60 V	
Internal overtemperature indication	+78°C (+75...+83°C)				

Table 10: Digital inputs

Power supply version	PS1/240 V (High)	PS1/240 V (Medium), PS2/240 V	PS1/48 V (Low), PS2/48V
Input voltage, dc	220 V	110/125/220 V	24/48/60/110/125/ 220 V
Nominal treshold voltage, dc - operating range, dc	155 V 155...265 V	80 V 80...265 V	18 V 18...265 V
Current drain	~2...25 mA		
Power consumption/input	<0.8 W		
Pulse counting (specific digital inputs), frequency range	0...100 Hz		
Time synchronization (specific digital inputs) synchronization rate	once per minute or once per second		

Table 11: RTD/analog inputs

Supported RTD sensors	100 Ω Platinum	TCR 0.00385 (DIN 43760)		
	250 Ω Platinum		TCR 0.00385	
	1000 Ω Platinum		TCR 0.00385	
	100 Ω Nickel	TCR 0.00618 (DIN 43760)		
			120 Ω Nickel	TCR 0.00618
			250 Ω Nickel	TCR 0.00618
			1000 Ω Nickel	TCR 0.00618
			10 Ω Copper	TCR 0.00427
120 Ω Nickel	TCR 0.00672 (MIL-T-24388C)			
Max lead resistance (three-wire measurement)	200 Ω per lead			
Accuracy	$\pm 0.5\%$ of full scale $\pm 1.0\%$ of full scale for 10 Ω Copper RTD			
Isolation	2 kV (inputs to outputs and inputs to protective earth)			
Sampling frequency	5 Hz			
Response time	\leq Filter time + 30 ms (430 ms...5.03 s)			
RTD/ Resistance sensing current	max 4.2 mA RMS 6.2 mA RMS for 10 Ω Copper			
Current input impedance	274 $\Omega \pm 0.1\%$			

Table 12: Analog outputs

Output range	0...20 mA
Accuracy	$\pm 0.5\%$ of full scale
Max load	600 Ω
Isolation	2 kV (output to output, output to inputs and output to protective earth)
Response time	≤ 85 ms

Table 13: Signal outputs

Max system voltage	250 V ac/dc
Continuous carry	5 A
Make and carry for 0.5 s	10 A
Make and carry for 3 s	8 A
Breaking capacity when control circuit time-constant L/R <40 ms, at 48/110/220 V dc	1 A/0.25 A/0.15 A

Table 14: Power outputs

Max system voltage		250 V ac/dc
Continuous carry		5 A
Make and carry for 0.5 s		30 A
Make and carry for 3 s		15 A
Breaking capacity when control circuit time constant L/R <40 ms, at 48/110/220 V dc		5 A/3 A/1 A
Minimum contact load		100 mA, 24 V ac/dc (2.4 VA)
TCS (Trip Circuit Supervision)	Control voltage range	20...265 V ac/dc
	Current drain through the supervision circuit	approx. 1.5 mA (0.99...1.72 mA)
	Minimum voltage (threshold) over a contact	20 V ac/dc (15...20 V)

Table 15: Environmental conditions

Specified service temperature range		-10...+55°C
Transport and storage temperature range		-40...+70°C
Degree of protection by enclosure	Front side, flush-mounted	IP 54
	Rear side, connection terminals	IP 20
Dry heat test		according to IEC 60068-2-2
Dry cold test		according to IEC 60068-2-1
Damp heat test, cyclic		according to IEC 60068-2-30 r.h. = 95%, T = 20°...55°C
Storage temperature tests		according to IEC 60068-2-48

Table 16: Standard tests

Insulation tests	Dielectric test IEC 60255-5	Test voltage	2 kV, 50 Hz, 1 min.
	Impulse voltage test IEC 60255-5	Test voltage	5 kV, unipolar impulses, waveform 1.2/50 μs, source energy 0.5 J
	Insulation resistance measurements IEC 60255-5	Insulation resistance	> 100 MΩ, 500 V dc
Mechanical tests	Vibration tests (sinusoidal)		IEC 60255-21-1, class I
	Shock and bump test		IEC 60255-21-2, class I
	Seismic test		IEC 60255-21-3, class 2

Table 17: Electromagnetic compatibility tests

The EMC immunity test level fulfills the requirements listed below		
1 MHz burst disturbance test, class III, IEC 60255-22-1	common mode	2.5 kV
	differential mode	1.0 kV
Electrostatic discharge test, class III, IEC 61000-4-2 and IEC 60255-22-2	for contact discharge	6 kV
	for air discharge	8 kV
Radio frequency interference test	conducted, common mode IEC 61000-4-6	10 V (rms), f = 150 kHz...80 MHz
	radiated, amplitude-modulated IEC 61000-4-3	10 V/m (rms), f = 80...1000 MHz
	radiated, pulse-modulated ENV 50204	10 V/m, f = 900 MHz
	radiated, test with a portable transmitter IEC 60255-22-3, method C	f = 77.2 MHz, P = 6 W; f = 172.25 MHz, P = 5 W

Table 17: Electromagnetic compatibility tests

Fast transient disturbance test (IEC 60255-22-4 and IEC 61000-4-4)	power supply	4 kV
	I/O ports	2 kV
Surge immunity test (IEC 61000-4-5)	power supply	4 kV, common mode 2 kV, differential mode
	I/O ports	2 kV, common mode 1 kV, differential mode
Power frequency (50 Hz) magnetic field, IEC 61000-4-8	100 A/m	
Voltage dips and short interruptions, IEC 61000-4-11	30%, 10 ms >90%, 5000 ms	
Electromagnetic emission tests EN 55011 and EN 50081-2	conducted RF emission (mains terminal)	EN 55011, class A
	radiated RF emission	EN 55011, class A
CE approval	Complies with the EMC directive 89/336/EEC and the LV directive 73/23/EEC	

Table 18: Data communication

Rear interface, connector X3.1	not used, reserved for future purposes	
Rear interface, connector X3.2	RS-232 connection	
	the fibre-optic interface module RER 123 for SPA and IEC_103	
	protocol	SPA, IEC_103
	RS-485 connection	
	the RS-485 interface module RER 133 for DNP 3.0 and Modbus	
	protocol	DNP 3.0, Modbus
Rear interface, connector X3.3	data transfer rates	
	DNP 3.0 and Modbus: 300 bps...19.2 kbps, selectable	
	RS-485 connection	
	LON bus or SPA bus, selectable	
	the fibre-optic interface module RER 103 is needed for galvanic isolation	
Rear interface, connector X3.4	data transfer rates	SPA bus: 4.8/9.6/19.2 kbps LON bus: 78.0 kbps/1.2 Mbps
	protocol	SPA, LON
	RJ45 connection	
	galvanically isolated RJ45 connection for an external display module	
Front panel	communication cable	1MRS 120511.001 (1 m) 1MRS 120511.002 (2 m) 1MRS 120511.003 (3 m)
	optical connection	
	protocol	SPA
SPA protocol	serial communication cable	1MRS 120511.001 (1 m)
	baud rates	4.8/9.6/19.2 kbps
	start bits	1
	data bits	7
	parity	even
LON protocol	stop bits	1
	bit rates	78.0 kbps/1.2 Mbps
IEC_103 protocol	baud rates	9.6/19.2 kbps
	data bits	8
	parity	even
	stop bits	1
DNP 3.0	bit rates	300, 600, 1200, 2400, 4800, 9600, 19200 bps
	data bits	8
	stop bits	1, 2
	parity	none, odd, even

Table 18: Data communication

Modbus RTU/ASCII	bit rates	300, 600, 1200, 2400, 4800, 9600, 19200 bps
	data bits	5, 6, 7, 8
	stop bits	1, 2
	parity	none, odd, even

Table 19: General

Toolboxes	CAP 501 CAP 505 LNT 505	
Event recording	all events are recorded in higher level syntax: reason, time, date the last 100 events are recorded	
Data recording	records operate values	
Protection functions Control functions Condition monitoring functions Measurement functions	see Technical Descriptions of Functions, CD-ROM (1MRS 750889-MCD)	
Self-supervision	RAMs ROMs EEPROMs all analog reference voltages automatic test sequences for I/Os and HMI modules output contact condition monitoring (all contacts)	
Mechanical dimensions	Width: 223.7 mm (1/2 of a 19" rack) Height, frame: 265.9 mm (6U) Height, box: 249.8 mm Depth: 235 mm	
	External display module	Width: 223.7 mm Height: 265.9 mm Depth: 74 mm
Weight of the unit	~8 kg	

Ordering

The following is to be specified when ordering RET 54_ transformer terminals:

- Order number (see figure below)
- Display language combination (e.g. English-German)
- Quantity of transformer terminals

Each RET 54_ transformer terminal has a specific order number that identifies the transformer terminal type as well as the hardware and the software as described in the figure below. The order number is printed on the marking strip on the front panel of the transformer terminal delivered, e.g. Order No: RET543AB230AAAA.

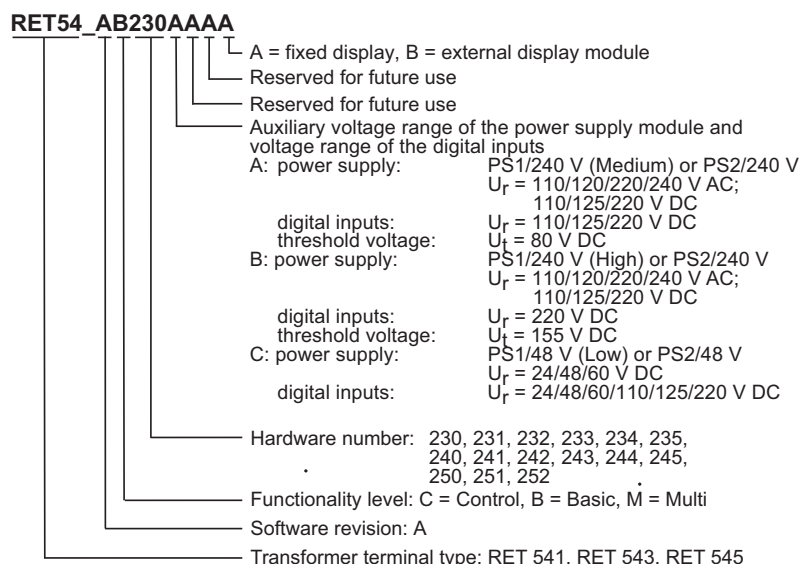

ret54_ordernumber_

Fig. 5 Order number of RET 54_ transformer terminal.

Language combinations

The display language combination (see table below) is identified by a three-digit suf-

fix in the software number labelled on the front panel of the transformer terminal, e.g. Software 1MRS110028-0_.

Suffix	Language combination
001	English-German
002	English-Swedish
003	English-Finnish
007	English-Portuguese
008	English-Polish
009	English-Russian
010	English-Spanish
011	English-Czech

Number of digital inputs/outputs

The RET 541, RET 543 and RET 545 transformer terminals differ from each other as to

the number of digital inputs and outputs as follows:

Number of inputs/outputs	RET 541	RET 543	RET 545
Digital inputs	15	25	34
Trip circuit supervision inputs	2	2	2
Power outputs (NO single-pole)	0	2	3
Power outputs (NO double-pole)	5	9	11
Signal outputs (NO)	2	2	4
Signal outputs (NO/NC)	5	5	8

Self-supervision outputs	1	1	1
--------------------------	---	---	---

Functionality levels

The functionality level determines the extent of the selection of function blocks available for the transformer terminal. For more detailed information on the separate function blocks included in each selection, please consult your relay supplier.

Functionality level	Selection of function blocks
C (Control)	All control ¹ , condition monitoring and measurement functions
B (Basic)	All control ¹ , condition monitoring and measurement functions, basic protection functions
M (Multi)	All control ¹ , condition monitoring, measurement and protection functions

1) The COLTC Tap Changer control function block comes as standard in the Control version. In the Basic and the Multi versions, COLTC is available as an option.

Table 20: Transformer terminal functionality levels

IEEE Code	IEC Symbol	Functions available in RET 541/543/545 Transformer Terminals. Processor capacity to be checked with "CPU load" tool	Code	FUNCTIONALITY LEVELS		
				RET541/3/5 CONTROL	RET541/3/5 BASIC	RET541/3/5 MULTI
Short circuit and overcurrent						
87T	3ΔI >, 3ΔI >>	Three-phase differential protection for transformers, stabilized and instantaneous stages	Di#8T		X	X
51 50 / 51 / 51B 50 / 51B	3I > 3I >> 3I >>>	Three-phase non-directional overcurrent, low-set stage Three-phase non-dir. overcurrent, high-set stage / blockable overcurrent Three-phase non-dir. overcurrent, inst. stage / blockable overcurrent Three-phase non-directional overcurrent function, low-set stage (B)	NOC3Low NOC3High NOC3Inst NOC3LowB		X	X
67 67 67	3I > -> 3I >> -> 3I >>> ->	Three-phase directional o/c, low-set stage Three-phase directional o/c, high-set stage / blockable overcurrent Three-phase directional o/c, high-set stage / blockable overcurrent	DOC6Low DOC6High DOC6Inst			X
21G 21G	Z< Z<<	Three-Phase Underimpedance Protection, Low-Set Stage Three-Phase Underimpedance Protection, High-Set Stage	UI6Low UI6High			X
Earth-fault						
51N 50N / 51N 50N	Io > / SEF Io >> Io >>>	Non-directional earth-fault, low-set stage Non-directional earth-fault, high-set stage Non-directional earth-fault, instantaneous stage	NEF1Low NEF1High NEF1Inst		X	X
67N / 51N 67N 67N	Io > / SEF -> Io >> -> Io >>> ->	Directional earth-fault, low-set stage Directional earth-fault, high-set stage Directional earth-fault, instantaneous stage	DEF2Low DEF2High DEF2Inst			X
59N 59N 59N	Uo > Uo >> Uo >>>	Residual overvoltage, low-set stage Residual overvoltage, high-set stage Residual overvoltage, instantaneous stage	ROV1Low ROV1High ROV1Inst			X
87N 87N 87N	ΔIo > ΔIo >> ΔIo >>, REF	Stabilized restricted earth-fault protection (high voltage side) Stabilized restricted earth-fault protection (low voltage side) High-impedance based restricted earth-fault protection	REF4A REF4B REF1A		X	X
Overload / unbalanced load						
49T	3 I ₂	Three-phase thermal overload protection	TOL3Dev		X	X
46 46	I ₂ > I ₂ >>	Negative-phase-sequence (NPS) protection, low-set stage Negative phase sequence (NPS) protection, high-set stage	NPS3Low NPS3High		X	X
Over / undervoltage						
59 59	3U > 3U >>	Three-phase overvoltage, low-set stage Three-phase overvoltage, high-set stage	OV3Low OV3High			X
27 27	3U < 3U <<	Three-phase undervoltage, low-set stage Three-phase undervoltage, high-set stage	UV3Low UV3High			X
47 47	U1< & U2> & U1> U1< & U2> & U1>	Three-phase phase sequence voltage protection, stage 1 Three-phase phase sequence voltage protection, stage 2	P.SV3S11 P.SV3S12			X
Over / under frequency						
81U / 81O 81U / 81O 81U / 81O 81U / 81O 81U / 81O	f < / f > / df/dt f < / f > / df/dt f < / f > / df/dt f < / f > / df/dt f < / f > / df/dt	Underfrequency or overfrequency inc. rate of change, stage 1 Underfrequency or overfrequency inc. rate of change, stage 2 Underfrequency or overfrequency inc. rate of change, stage 3 Underfrequency or overfrequency inc. rate of change, stage 4 Underfrequency or overfrequency inc. rate of change, stage 5	Freq1 S1 Freq1 S2 Freq1 S3 Freq1 S4 Freq1 S5			X
Over / under excitation						
24 24	U/f> U/f>>	Overexcitation Protection, Low-Set Stage U/f> Overexcitation Protection, High-Set Stage U/f>>	OE1Low OE1High			X
Additional functions						
68 60 62BF	3I2f > FUSEF CBFP	Three-phase inrush detector Fuse failure supervision Circuit breaker failure	Inrush3 FuseFail -		X X X	X X X
Measurement function						
Current						
	3I 3I Io Io	Three-phase current Three-phase current, B -stage Neutral current Neutral current, B -stage	MECU3A MECU3B MECU1A MECU1B	X	X	X
Voltage						
	3U 3U Uo Uo	Three-phase voltage Three-phase voltage, B -stage Residual voltage Residual voltage, B -stage	MEVO3A MEVO3B MEVO1A MEVO1B	X	X	X
Energy / Power						
	E / P / Q / pf	Three-phase power and energy (incl. cos φ)	MEPE7	X	X	X
Frequency						
	f	System frequency	MEFR1	X	X	X
Recording						
	⇒	Transient disturbance recorder	MEDREC16	X	X	X
In versions with RID1 -card						
		Measurement of RTD/analogue -inputs, general measurement Control of analogue -outputs	ME A1 ... 8 ME A01 ... 4	X	X	X

Transformer Terminals functionality levels, cont.

IEEE Code	IEC Symbol	Condition monitoring function	Code			
		Circuit breaker				
	CBCM	CB electric wear 1	CMBWEAR1			
	CBCM	CB electric wear 2	CMBWEAR2			
	CBCM	Operation Time Counter 1 (e.g. motors)	CMTIME1			
	CBCM	Operation Time Counter 2 (e.g. motors)	CMTIME2			
	CBCM	Gas density supervision	CMGAS1	X	X	X
	CBCM	Gas density supervision for three poles	CMGAS3			
	CBCM	Spring charging control 1	CMSPRC1			
	CBCM	Breaker travel time 1	CMTRAV1			
	CBCM	Scheduled maintenance	CMSCHED			
		Trip circuit				
	TCS	Trip Circuit Supervision 1	CMTCS1	X	X	X
	TCS	Trip Circuit Supervision 2	CMTCS2			
		Measuring circuit				
	MCS	Supervision of the energizing current input circuit	CMCU3	X	X	X
	MCS	Supervision of the energizing voltage input circuit	CMVO3			
		Control function				
		Circuit breakers, disconnectors / earthing switch				
		Circuit breaker 1..2 (2 state inputs / 2 control outputs)	COCB1...2			
		Disconnector 1...5 (2 state inputs / 2 control outputs)	CO3DC1...5			
		Three state disconnector 1, 2 (3 state inputs / 4 control outputs)	CO3DC1..2			
		Object indication 1..8 (2 state inputs)	COIND1...8			
		MMIC dynamic data point 1..5 on MMI (single line diagram)	MMIDATA1..5	X	X	X
		Alarm 1..8 on MMI (alarm view)	MMIALAR1...8			
		On/off switch 1..4 on MMI (single line diagram)	COSW1...4			
		Direct open for CBs via MMI	COCBDIR			
		Logic control position selector	COLOCAT			
		Additional functions				
		Interlocking	-	X	X	X
		Command control	-			
		Standard functions				
		Operation indication, relay and register reset	INDRESET	X	X	X
		Activation of MMI backlight	MMIWAKE			
		Switchgroups SWGRP1...SWGRP20	SWGRP1...20			
		PLC logics (AND, OR, timers etc.) acc. to IEC 1131-3	-			
		Data communication				
		Event to be defined by the customer, E0...E63	EVENT230	X	X	X
		SPA bus	-			
		LON bus	-			
		General functions				
		Main / secondary setting		X	X	X
		Remote setting				
		Selfsupervision				
		Annunciating, event generating and value recording				
		Measurement, parameter and switching device status display				
		Remote-end binary signal transfer				
		Binary signal interbay transfer				
		Options				
		Dual HMI language, desired language combination must be stated in the purchase order		o	o	o
		On-load tap changer controller (voltage regulator), to be ordered as a separate item (1MRS 100144)	COLTC	X	o	o

RET54_Functionality2.xls

Hardware versions of RET 541, RET 543 and RET 545

For the number of digital inputs and outputs of RET 54_ transformer terminals, refer to section “Order number” above. The number of matching transformers and analog inputs and outputs, and the auxiliary voltage range vary between the different hardware versions

of RET 54_. Moreover, RET 541 and RET 543 can be supplied with an RTD/analog module. For more detailed information about the hardware of RET 54_, refer to the tables 20...28 below.

Table 21: Hardware versions of RET 541, 6I/3U transformers

HW modules	Order number									
	RET541A_230AAAA	RET541A_230BAAA	RET541A_230CAAA	RET541A_230AAAB	RET541A_230BAAB	RET541A_233AAAA	RET541A_233BAAA	RET541A_233CAAA	RET541A_233AAAB	RET541A_233BAAB
Analog interface										
Current rafo 1/5 A	6	6	6	6	6	6	6	6	6	6
Voltage trafo 100 V	3	3	3	3	3	3	3	3	3	3
Main processor boards										
CPU module	1	1	1	1	1	1	1	1	1	1
Power supply boards										
PS1: 80...265 VDC/AC (High)		1			1		1			1
PS1: 80...265 VDC /AC (Medium)	1			1		1			1	
PS1: 18...80 VDC (Low)			1					1		
PS2: 80...265 VDC/AC										
PS2: 18...80 VDC										
Digital I/O boards										
BIO1: Threshold voltage 155 VDC		1			1		1			1
BIO1: threshold voltage 80 VDC	1			1		1			1	
BIO1: threshold voltage 18 VDC			1					1		
BIO2: Threshold voltage 155 VDC										
BIO2: threshold voltage 80 VDC										
BIO2: threshold voltage 18 VDC										
Analog I/O board										
RTD/analog module						1	1	1	1	1
Display boards										
Graphic HMI display, fixed	1	1	1			1	1	1		
Graphic HMI display, external				1	1				1	1
Mechanic										
1/2 enclosure	1	1	1	1	1	1	1	1	1	1
Digital inputs										
	15					15				
Power outputs, single pole										
	0					0				
Power outputs, double pole										
	5					5				
Signal outputs (NO)										
	2					2				
Signal outputs (NO/NC)										
	5					5				
Supervised trip circuits										
	2					2				
IRF outputs										
	1					1				
RTD/analog inputs										
	0					8				
Analog outputs										
	0					4				

Table 22: Hardware versions of RET 541, 7I/2U transformers

HW modules	Order number									
	RET541A_231AAAA	RET541A_231BAAA	RET541A_231CAAA	RET541A_231AAAB	RET541A_231BAAB	RET541A_234AAAA	RET541A_234BAAA	RET541A_234CAAA	RET541A_234AAAB	RET541A_234BAAB
Analog interface										
Current trafo 1/5 A	7	7	7	7	7	7	7	7	7	7
Voltage trafo 100 V	2	2	2	2	2	2	2	2	2	2
Main processor boards										
CPU module	1	1	1	1	1	1	1	1	1	1
Power supply boards										
PS1: 80...265 VDC/AC (High)		1			1		1			1
PS1: 80...265 VDC /AC (Medium)	1			1		1			1	
PS1: 18...80 VDC (Low)			1					1		
PS2: 80...265 VDC/AC										
PS2: 18...80 VDC										
Digital I/O boards										
BIO1: threshold voltage 155 VDC		1			1		1			1
BIO1: threshold voltage 80 VDC	1			1		1			1	
BIO1: threshold voltage 18 VDC			1					1		
BIO2: threshold voltage 155 VDC										
BIO2: threshold voltage 80 VDC										
BIO2: threshold voltage 18 VDC										
Analog I/O board										
RTD/analog module						1	1	1	1	1
Display boards										
Graphic HMI display, fixed	1	1	1			1	1	1		
Graphic HMI display, external				1	1				1	1
Mechanic										
1/2 enclosure	1	1	1	1	1	1	1	1	1	1
Digital inputs										
	15					15				
Power outputs, single pole										
	0					0				
Power outputs, double pole										
	5					5				
Signal outputs (NO)										
	2					2				
Signal outputs (NO/NC)										
	5					5				
Supervised trip circuits										
	2					2				
IRF outputs										
	1					1				
RTD/analog inputs										
	0					8				
Analog outputs										
	0					4				

Table 23: Hardware versions of RET 541, 8I/1U transformers

HW modules	Order number									
	RET541A_232AAAA	RET541A_232BAAA	RET541A_232CAAA	RET541A_232AAAB	RET541A_232BAAB	RET541A_235AAAA	RET541A_235BAAA	RET541A_235CAAA	RET541A_235AAAB	RET541A_235BAAB
Analog interface										
Current rafo 1/5 A	8	8	8	8	8	8	8	8	8	8
Voltage trafo 100 V	1	1	1	1	1	1	1	1	1	1
Main processor boards										
CPU module	1	1	1	1	1	1	1	1	1	1
Power supply boards										
PS1: 80...265 VDC/AC (High)		1			1		1			1
PS1: 80...265 VDC /AC (Medium)	1			1		1			1	
PS1: 18...80 VDC (Low)			1					1		
PS2: 80...265 VDC/AC										
PS2: 18...80 VDC										
Digital I/O boards										
BIO1: threshold voltage 155 VDC		1			1		1			1
BIO1: threshold voltage 80 VDC	1			1		1			1	
BIO1: threshold voltage 18 VDC			1					1		
BIO2: threshold voltage 155 VDC										
BIO2: threshold voltage 80 VDC										
BIO2: threshold voltage 18 VDC										
Analog I/O board										
RTD/analog module						1	1	1	1	1
Display boards										
Graphic HMI display, fixed	1	1	1			1	1	1		
Graphic HMI display, external				1	1				1	1
Mechanic										
1/2 enclosure	1	1	1	1	1	1	1	1	1	1
Digital inputs										
	15					15				
Power outputs, single pole										
	0					0				
Power outputs, double pole										
	5					5				
Signal outputs (NO)										
	2					2				
Signal outputs (NO/NC)										
	5					5				
Supervised trip circuits										
	2					2				
IRF outputs										
	1					1				
RTD/analog inputs										
	0					8				
Analog outputs										
	0					4				

Table 24: Hardware versions of RET 543, 6I/3U transformers

HW modules	Order number									
	RET543A_240AAAA	RET543A_240BAAA	RET543A_240CAAA	RET543A_240AAAB	RET543A_240BAAB	RET543A_243AAAA	RET543A_243BAAA	RET543A_243CAAA	RET543A_243AAAB	RET543A_243BAAB
Analog interface										
Current trafo 1/5 A	6	6	6	6	6	6	6	6	6	6
Voltage trafo 100 V	3	3	3	3	3	3	3	3	3	3
Main processor boards										
CPU module	1	1	1	1	1	1	1	1	1	1
Power supply boards										
PS1: 80...265 VDC/AC (High)		1			1		1			1
PS1: 80...265 VDC/AC (Medium)	1			1		1			1	
PS1: 18...80 VDC (Low)			1					1		
PS2: 80...265 VDC/AC										
PS2: 18...80 VDC										
Digital I/O boards										
BIO1: threshold voltage 155 VDC		1			1		1			1
BIO1: threshold voltage 80 VDC	1			1		1			1	
BIO1: threshold voltage 18 VDC			1					1		
BIO2: threshold voltage 155 VDC		1			1		1			1
BIO2: threshold voltage 80 VDC	1			1		1			1	
BIO2: threshold voltage 18 VDC			1					1		
Analog I/O board										
RTD/analog module						1	1	1	1	1
Display boards										
Graphic HMI display, fixed	1	1	1			1	1	1		
Graphic HMI display external				1	1				1	1
Mechanic										
1/2 enclosure	1	1	1	1	1	1	1	1	1	1
Digital inputs										
	25					25				
Power outputs, single pole										
	2					2				
Power outputs, double pole										
	9					9				
Signal outputs (NO)										
	2					2				
Signal outputs (NO/NC)										
	5					5				
Supervised trip circuits										
	2					2				
IRF outputs										
	1					1				
RTD/analog inputs										
	0					8				
Analog outputs										
	0					4				

Table 25: Hardware versions of RET 543, 7I/2U transformers

HW modules	Order number									
	RET543A_241AAAA	RET543A_241BAAA	RET543A_241CAAA	RET543A_241AAAB	RET543A_241BAAB	RET543A_244AAAA	RET543A_244BAAA	RET543A_244CAAA	RET543A_244AAAB	RET543A_244BAAB
Analog interface										
Current trafo 1/5 A	7	7	7	7	7	7	7	7	7	7
Voltage trafo 100 V	2	2	2	2	2	2	2	2	2	2
Main processor boards										
CPU module	1	1	1	1	1	1	1	1	1	1
Power supply boards										
PS1: 80...265 VDC/AC (High)		1			1		1			1
PS1: 80...265 VDC/AC (Medium)	1			1		1			1	
PS1: 18...80 VDC (Low)			1					1		
PS2: 80...265 VDC/AC										
PS2: 18...80 VDC										
Digital I/O boards										
BIO1: threshold voltage 155 VDC		1			1		1			1
BIO1: threshold voltage 80 VDC	1			1		1			1	
BIO1: threshold voltage 18 VDC			1					1		
BIO2: threshold voltage 155 VDC		1			1		1			1
BIO2: threshold voltage 80 VDC	1			1		1			1	
BIO2: threshold voltage 18 VDC			1					1		
Analog I/O board										
RTD/analog module						1	1	1	1	1
Display boards										
Graphic HMI display, fixed	1	1	1			1	1	1		
Graphic HMI display, external				1	1				1	1
Mechanic										
1/2 enclosure	1	1	1	1	1	1	1	1	1	1
Digital inputs										
	25					25				
Power outputs, single pole										
	2					2				
Power outputs, double pole										
	9					9				
Signal outputs (NO)										
	2					2				
Signal outputs (NO/NC)										
	5					5				
Supervised trip circuits										
	2					2				
IRF outputs										
	1					1				
RTD/analog inputs										
	0					8				
Analog outputs										
	0					4				

Table 26: Hardware versions of RET 543, 8I/1U transformers

HW modules	Order number									
	RET543A_242AAAA	RET543A_242BAAA	RET543A_242CAAA	RET543A_242AAAB	RET543A_242BAAB	RET543A_245AAAA	RET543A_245BAAA	RET543A_245CAAA	RET543A_245AAAB	RET543A_245BAAB
Analog interface										
Current trafo 1/5 A	8	8	8	8	8	8	8	8	8	8
Voltage trafo 100 V	1	1	1	1	1	1	1	1	1	1
Main processor boards										
CPU module	1	1	1	1	1	1	1	1	1	1
Power supply boards										
PS1: 80...265 VDC/AC (High)		1			1		1			1
PS1: 80...265 VDC/AC (Medium)	1			1		1			1	
PS1: 18...80 VDC (Low)			1					1		
PS2: 80...265 VDC/AC										
PS2: 18...80 VDC										
Digital I/O boards										
BIO1: threshold voltage 155 VDC		1			1		1			1
BIO1: threshold voltage 80 VDC	1			1		1			1	
BIO1: threshold voltage 18 VDC			1					1		
BIO2: threshold voltage 155 VDC		1			1		1			1
BIO2: threshold voltage 80 VDC	1			1		1			1	
BIO2: threshold voltage 18 VDC			1					1		
Analog I/O board										
RTD/analog module						1	1	1	1	1
Display boards										
Graphic HMI display, fixed	1	1	1			1	1	1		
Graphic HMI display external				1	1				1	1
Mechanic										
1/2 enclosure	1	1	1	1	1	1	1	1	1	1
Digital inputs										
	25					25				
Power outputs, single pole										
	2					2				
Power outputs, double pole										
	9					9				
Signal outputs (NO)										
	2					2				
Signal outputs (NO/NC)										
	5					5				
Supervised trip circuits										
	2					2				
IRF outputs										
	1					1				
RTD/analog inputs										
	0					8				
Analog outputs										
	0					4				

Table 27: Hardware versions of RET 545, 6I/3U transformers

HW modules	Order number				
	RET545A_250AAAA	RET545A_250BAAA	RET545A_250CAAA	RET545A_250AAAB	RET545A_250BAAB
Analog interface					
Current trafo 1/5 A	6	6	6	6	6
Voltage trafo 100 V	3	3	3	3	3
Main processor boards					
CPU module	1	1	1	1	1
Power supply boards					
PS1: 80...265 VDC/AC (High)					
PS1: 80...265 VDC/AC (Medium)					
PS1: 18...80 VDC (Low)					
PS2: 80...265 VDC/AC	1	1		1	1
PS2: 18...80 VDC			1		
Digital I/O boards					
BIO1: threshold voltage 155 VDC		2			2
BIO1: threshold voltage 80 VDC	2			2	
BIO1: threshold voltage 18 VDC			2		
BIO2: threshold voltage 155 VDC		1			1
BIO2: threshold voltage 80 VDC	1			1	
BIO2: threshold voltage 18 VDC			1		
Analog I/O board					
RTD/analog module					
Display boards					
Graphic HMI display, fixed	1	1	1		
Graphic HMI display, external				1	1
Mechanic					
1/2 enclosure	1	1	1	1	1
Digital inputs	34				
Power outputs, single pole	3				
Power outputs, double pole	11				
Signal outputs (NO)	4				
Signal outputs (NO/NC)	8				
Supervised trip circuits	2				
IRF outputs	1				
RTD/analog inputs	0				
Analog outputs	0				

Table 28: Hardware versions of RET 545, 7I/2U transformers

HW modules	Order number				
	RET545A_251AAAA	RET545A_251BAAA	RET545A_251CAAA	RET545A_251AAAB	RET545A_251BAAB
Analog interface					
Current trafo 1/5 A	7	7	7	7	7
Voltage trafo 100 V	2	2	2	2	2
Main processor boards					
CPU module	1	1	1	1	1
Power supply boards					
PS1: 80...265 VDC/AC (High)					
PS1: 80...265 VDC/AC (Medium)					
PS1: 18...80 VDC (Low)					
PS2: 80...265 VDC/AC	1	1		1	1
PS2: 18...80 VDC			1		
Digital I/O boards					
BIO1: threshold voltage 155 VDC		2			2
BIO1: threshold voltage 80 VDC	2			2	
BIO1: threshold voltage 18 VDC			2		
BIO2: threshold voltage 155 VDC		1			1
BIO2: threshold voltage 80 VDC	1			1	
BIO2: threshold voltage 18 VDC			1		
Analog I/O board					
RTD/analog module					
Display boards					
Graphic HMI display, fixed	1	1	1		
Graphic HMI display, external				1	1
Mechanic					
1/2 enclosure	1	1	1	1	1
Digital inputs					
	34				
Power outputs, single pole					
	3				
Power outputs, double pole					
	11				
Signal outputs (NO)					
	4				
Signal outputs (NO/NC)					
	8				
Supervised trip circuits					
	2				
IRF outputs					
	1				
RTD/analog inputs					
	0				
Analog outputs					
	0				

Table 29: Hardware versions of RET 545, 8I/1U transformers

HW modules	Order number				
	RET545A_252AAAA	RET545A_252BAAA	RET545A_252CAAA	RET545A_252AAAB	RET545A_252BAAB
Analog interface					
Current trafo 1/5 A	8	8	8	8	8
Voltage trafo 100 V	1	1	1	1	1
Main processor boards					
CPU module	1	1	1	1	1
Power supply boards					
PS1: 80...265 VDC/AC (High)					
PS1: 80...265 VDC/AC (Medium)					
PS1: 18...80 VDC (Low)					
PS2: 80...265 VDC/AC	1	1		1	1
PS2: 18...80 VDC			1		
Digital I/O boards					
BIO1: threshold voltage 155 VDC		2			2
BIO1: threshold voltage 80 VDC	2			2	
BIO1: threshold voltage 18 VDC			2		
BIO2: threshold voltage 155 VDC		1			1
BIO2: threshold voltage 80 VDC	1			1	
BIO2: threshold voltage 18 VDC			1		
Analog I/O board					
RTD/analog module					
Display boards					
Graphic HMI display, fixed	1	1	1		
Graphic HMI display, external				1	1
Mechanic					
1/2 enclosure	1	1	1	1	1
Digital inputs					
	34				
Power outputs, single pole					
	3				
Power outputs, double pole					
	11				
Signal outputs (NO)					
	4				
Signal outputs (NO/NC)					
	8				
Supervised trip circuits					
	2				
IRF outputs					
	1				
RTD/analog inputs					
	0				
Analog outputs					
	0				

Software configuration

Each RET 54_ transformer terminal allows various software configurations based on separate functions. Functions included in the selected functionality level can be activated

within the scope of the I/O connections and considering the total CPU load of the functions.

Parts and assembly descriptions

To achieve the best possible operation accuracy, all parts of a RET 54_ product have been calibrated together. Thus, each product forms a whole for which no separate spare

parts can be supplied. In the event of malfunction, please consult your transformer terminal supplier.

Application examples

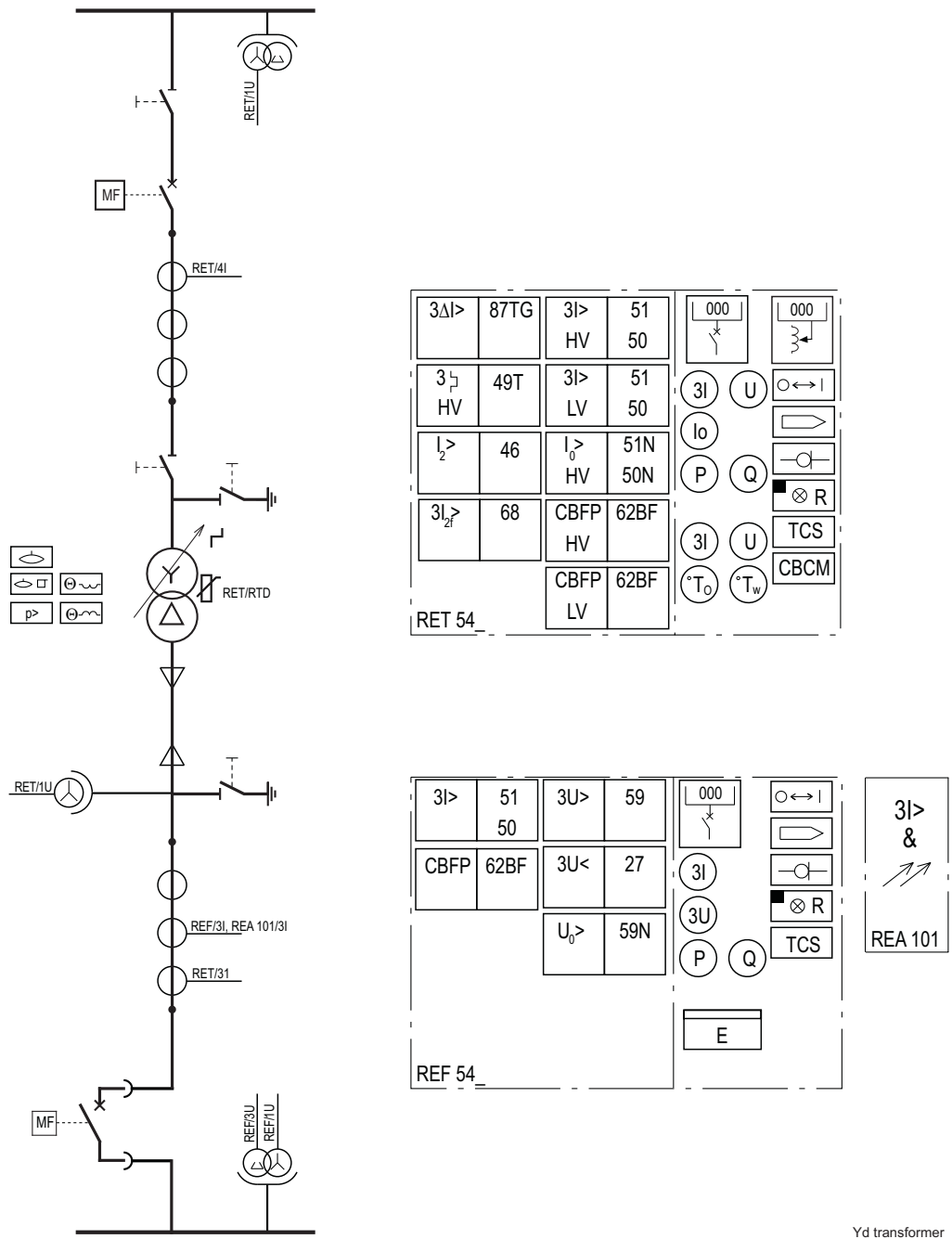

Fig. 6 Protection, control and supervision functions of a Yd-connected power transformer, implemented with RET 543 transformer terminal, REF543 feeder terminal and REA 101 arc protection. Position indication of the on-load tap changer is used to increase the sensitivity of the differential function of the transformer. In this example, the voltage controller is not included in the RET 543 transformer terminal.

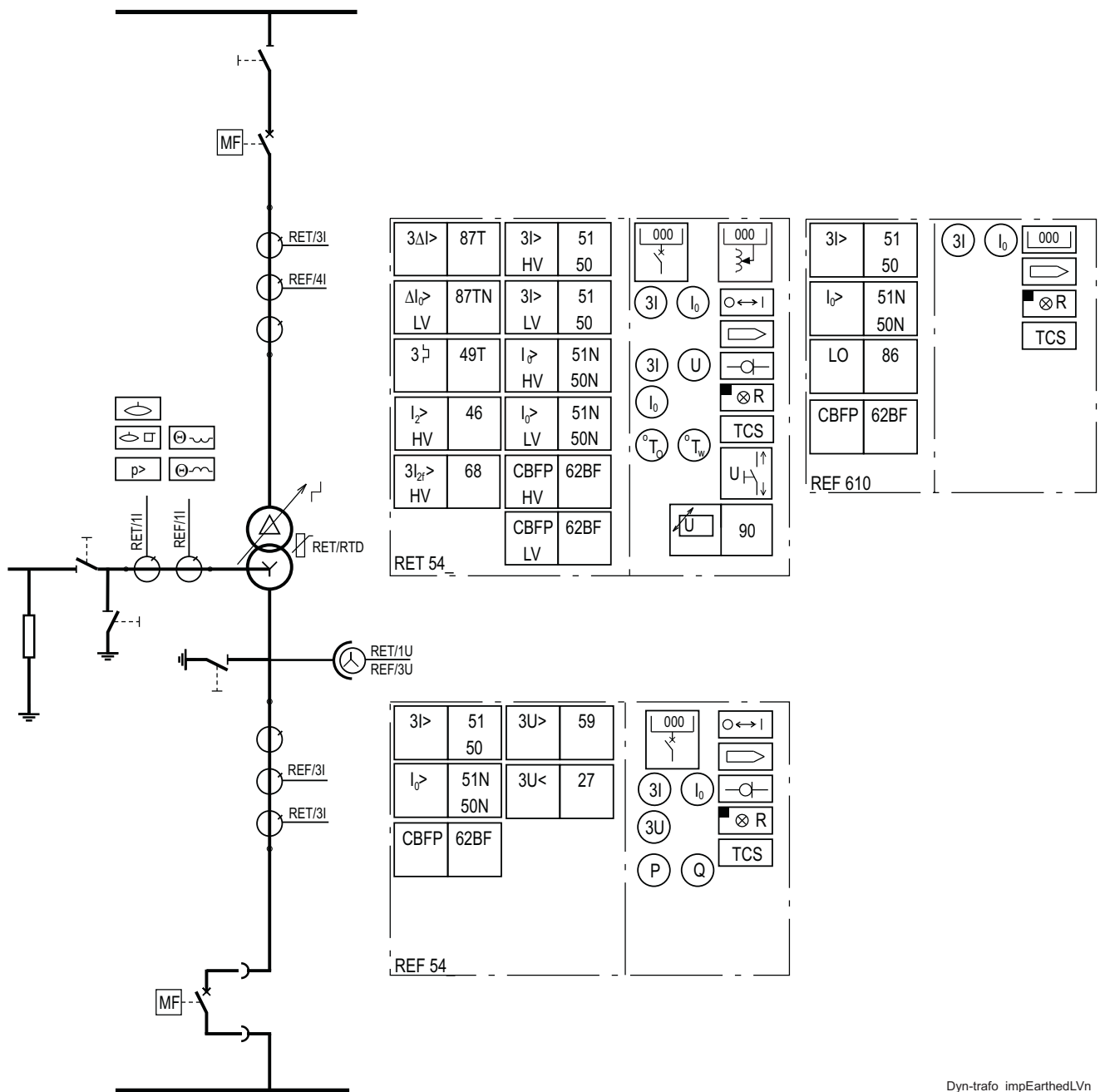

Fig. 7 Protection, control, measurement and supervision functions of an Dyn-connected power transformer, implemented with RET 543 transformer terminal and an REF 543 feeder terminal. The neutral point of the low-voltage network is earthed via a high impedance. REF 610 is used as a backup relay on the high-voltage side. This scheme can be applied also for parallel connected transformers.

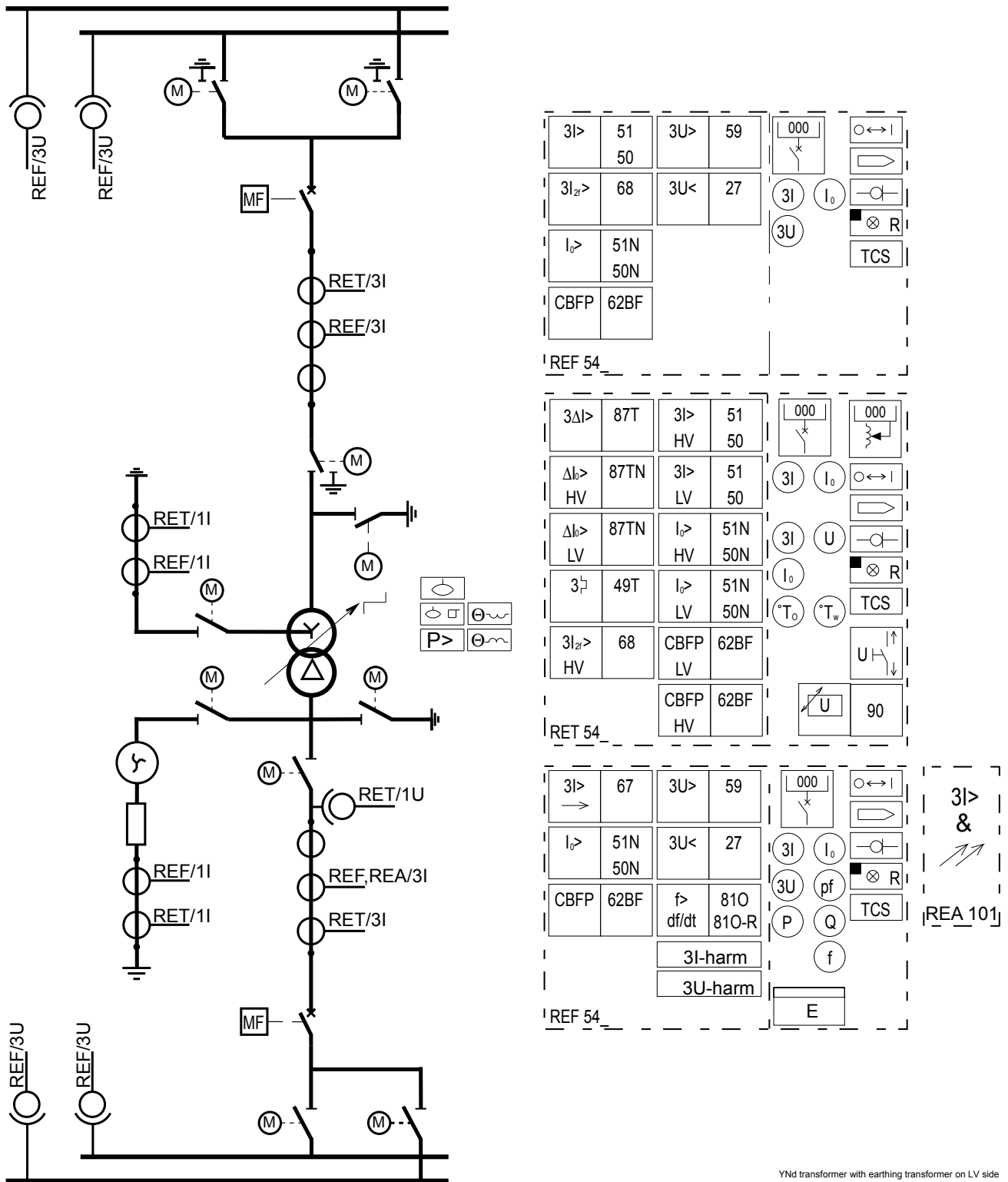

Fig. 8 Protection, control, measurement and supervision functions of a YNd-connected power transformer, implemented with an RET 543 transformer terminal, REF 543 feeder terminals and REA 101 arc protection. The low-voltage network is earthed via a zig-zag earthing transformer.

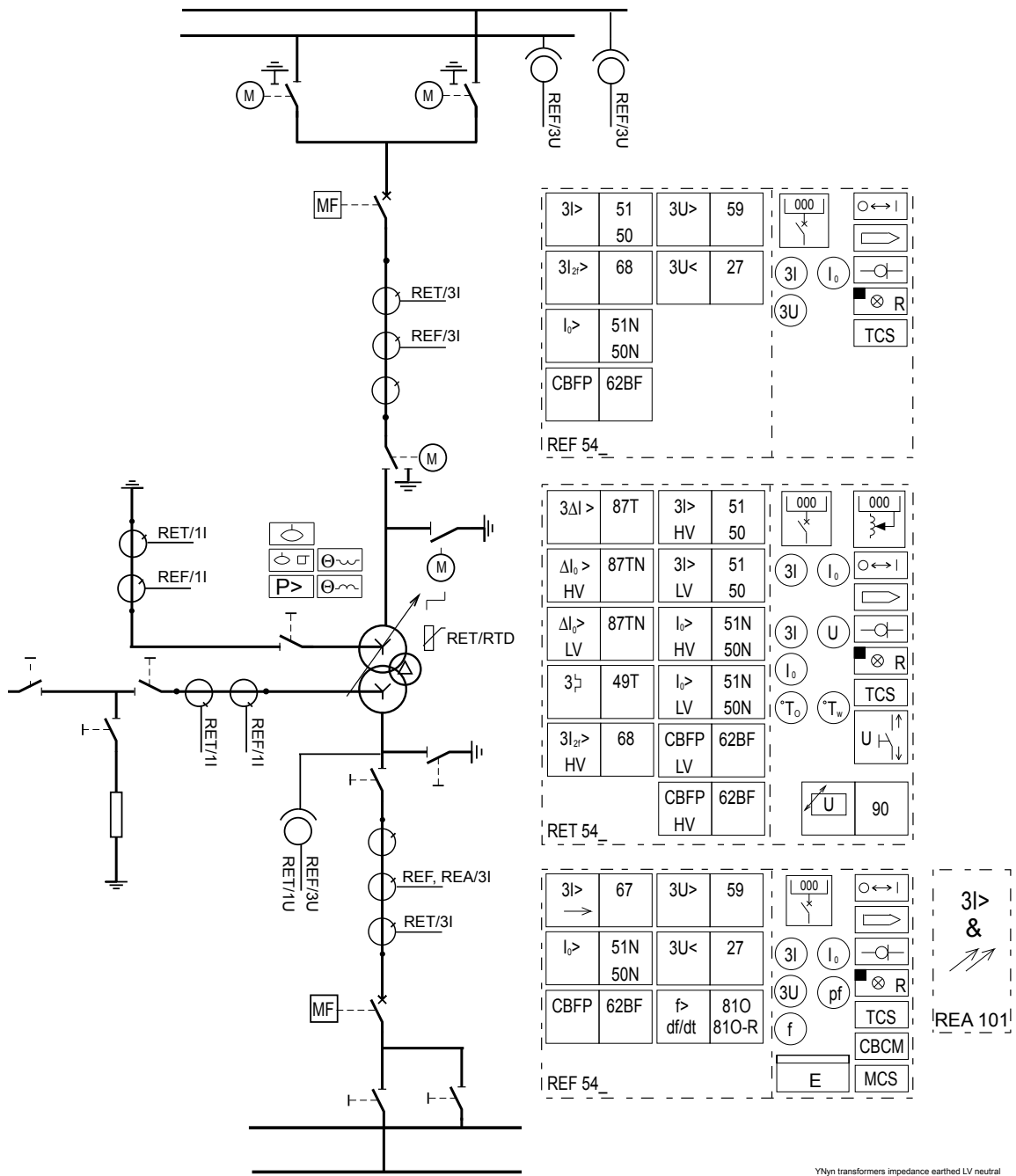

Fig. 9 Protection, control, measurement and supervision functions of YNyn-connected power transformers, implemented with RET 543 transformer terminals, REF 543 feeder terminals and REA 101 arc protection. The neutral point of the low-voltage network is earthed via a low resistance. The scheme is also applicable to other types of low-impedance earthed networks, where the neutral point is earthed effectively or via a low reactance. This scheme can be applied also for parallel connected transformers.

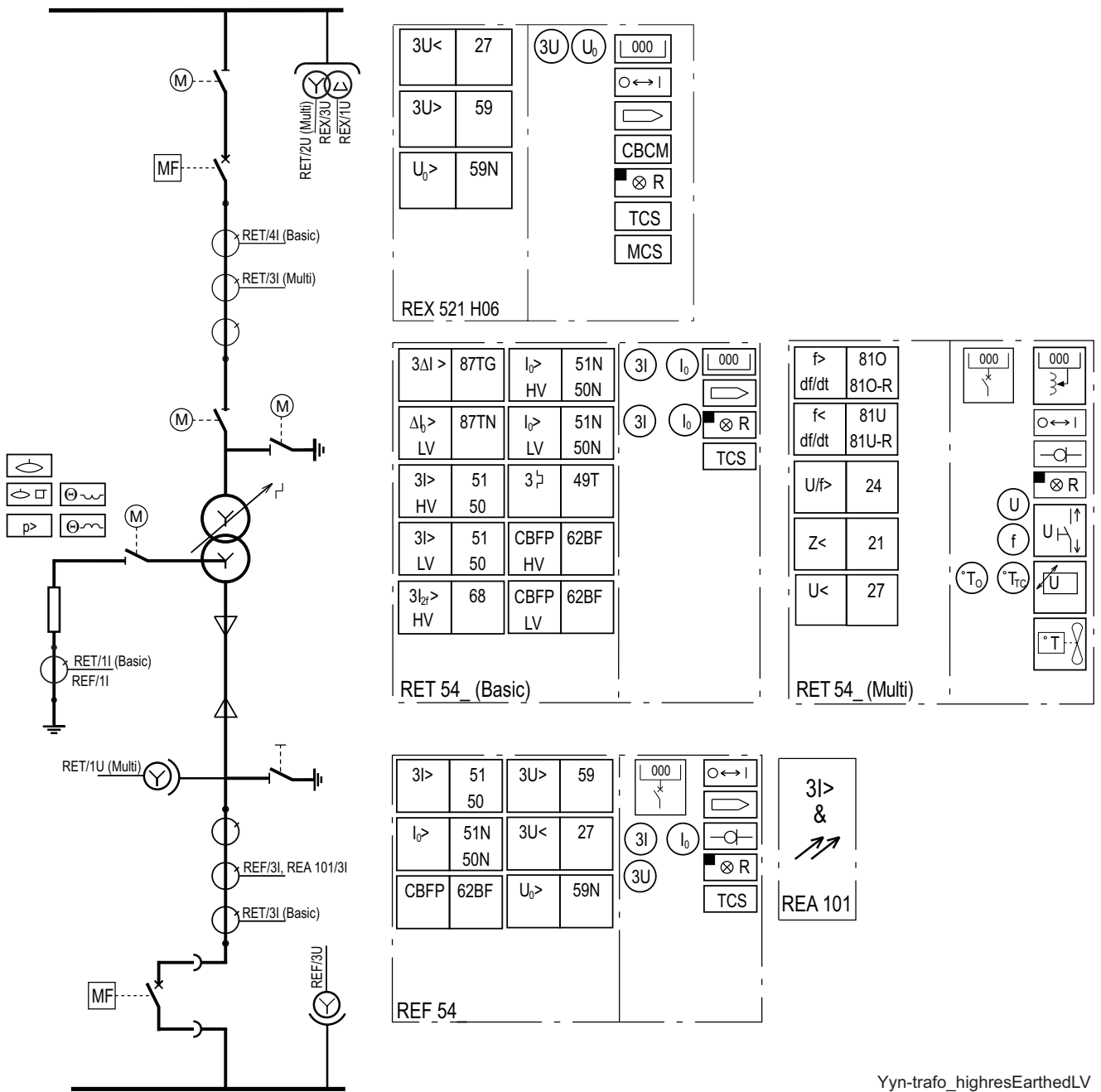
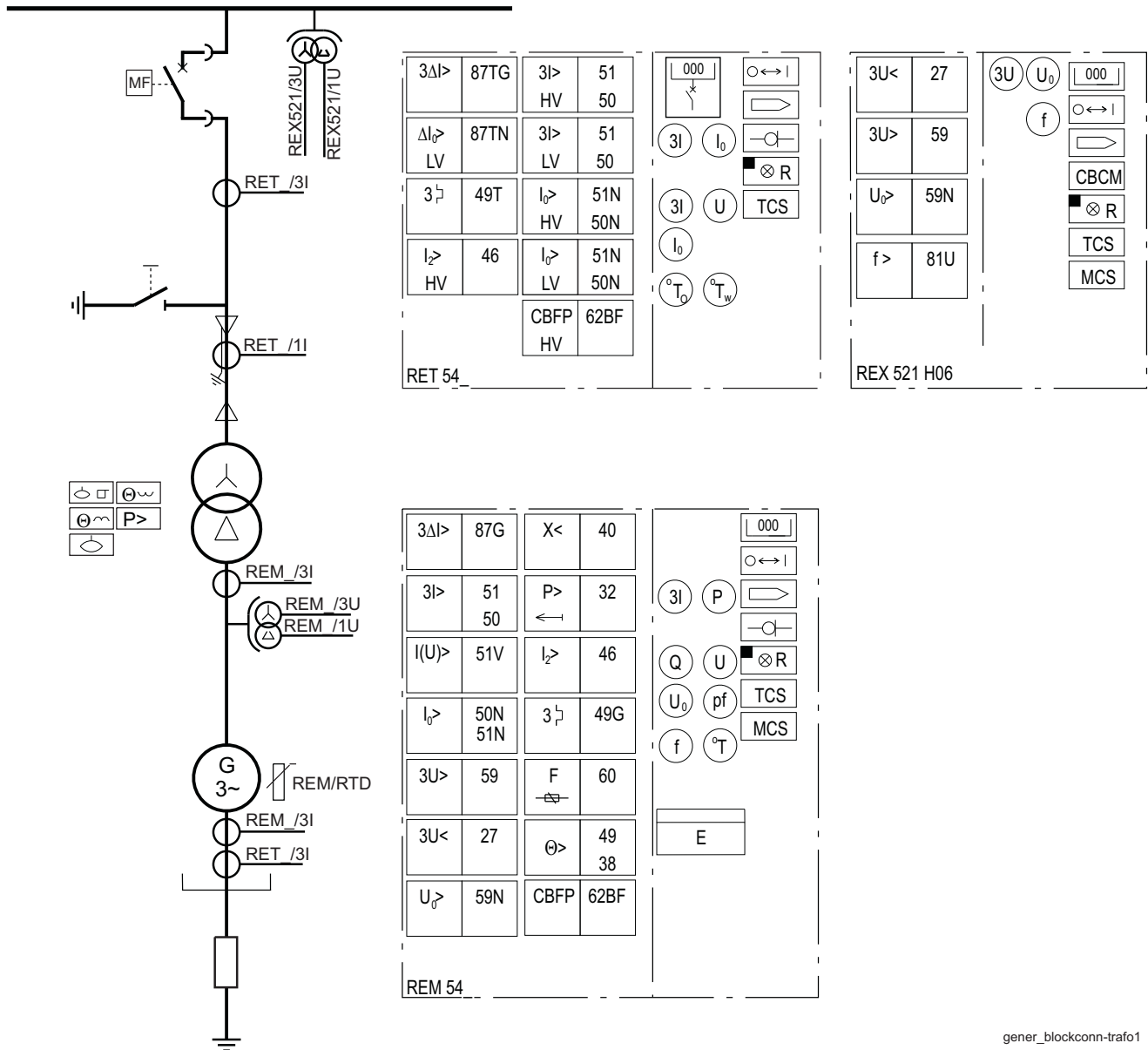
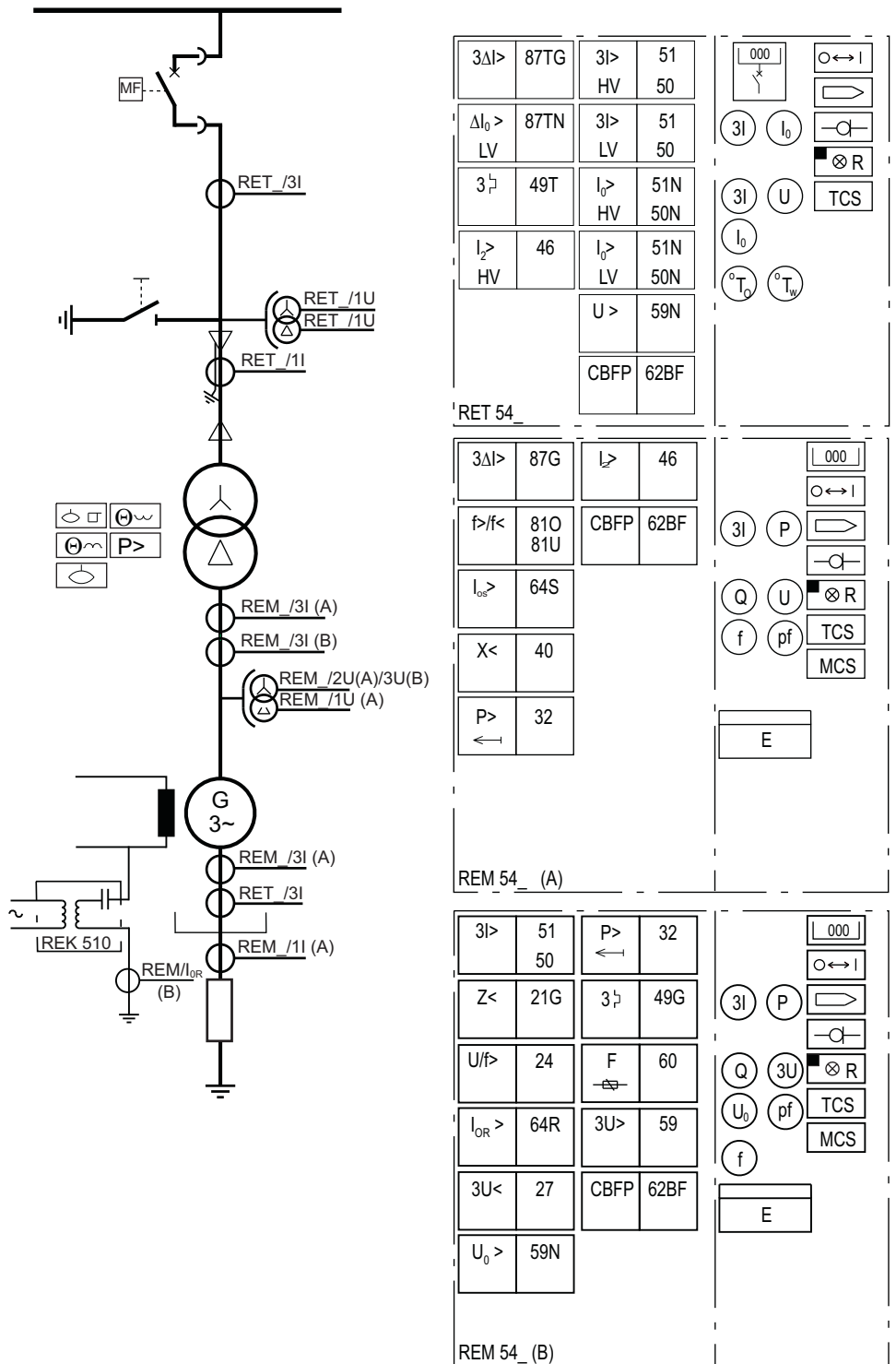

Fig. 10 Protection, control, measurement and supervision functions of an Yyn-connected industrial power transformer, implemented with RET 543 transformer terminals, an REF 543 feeder terminal, an REX 521 protection relay and REA 101 arc protection. The neutral point of the low-voltage network is earthed via a high resistance.



gener_blockconn-trafo1

Fig. 11 Transformer in block connection with a generator. The transformer terminal RET 543 is used for overall differential protection. An earthing resistor is recommended for the generator. The REX 521 protection relay is used for abnormal voltage and frequency supervision and protection of the network and the machine.

















gen_blockconn-trafo2

Fig. 12 Transformer in block connection with a generator. The transformer terminal RET 543 is used for overall differential protection. An earthing resistor is recommended for the generator. Generator protection functions are divided for two REM 543 machine terminals (A and B). The current injection device REK 510 is used in the rotor earth-fault protection scheme.

$3I >$	50/51	= multiple-stage three-phase overcurrent protection, double low-set, high-set and instantaneous stages available (NOC3_)
$3I > \rightarrow$	67	= multiple-stage three-phase directional overcurrent protection, low-set, high-set and instantaneous stage available (DOC6_)
$I_0 >$	50N/51N	= multiple-stage earth-fault protection, low-set, high-set and instantaneous stage available (NEF1_)
$I_2 >$	46	= negative phase sequence (NPS) protection, low-set and high-set stages available (NPS3_)
$3I_{2f} >$	68	= inrush detection based on the 2nd harmonic content of phase currents, applied for preventing possible unnecessary operation of overcurrent or earth-fault protection during transformer switching-in or to start cold load pick-up logic (Inrush3_)
$3\Delta I >$	87T	= three phase differential protection for transformers, stabilized and instantaneous stages (Diff3)
$3\Delta I >$	87TG	= overall differential protection for generator and transformer blocks, stabilized and instantaneous stages (Diff6T)
$\Delta I_0 >$	87TN	= restricted earth-fault (REF) protection, low- or high-impedance type (Diff3)
$I(U) >$	51V	= voltage-dependent overcurrent protection, low-set and high-set stages available (VOC6_)
$I_{0S} >$	64S	= stator earth-fault protection (NEF1_)
$I_{0R} >$	64R	= rotor earth-fault protection (NEF1_)
U/f	24	= overexcitation protection, low-set and high-set stages available (OE1_)
$U <$	27	= undervoltage protection, low-set and high-set stage available (UV3_)
$3U <$	27	= three-phase undervoltage protection, low-set and high-set stage available (UV3_)
$3U >$	59	= three-phase overvoltage protection, low-set and high-set stage available (OV3_)
$U_0 >$	59N	= multiple-stage residual overvoltage protection, low-set, high-set and instantaneous stage available (ROV1_)
$f >$	81U	= overfrequency protection (incl. in Freq1St_)
$f >$ df/dt	81U 81U-R	= overfrequency protection and frequency rate of change function (incl. in Freq1St_)
$f <$ df/dt	81O 81O-R	= underfrequency protection and frequency rate of change function (incl. in Freq1St_)
$f >/f <$	81O 81U	= over/underfrequency protection (incl. in Freq1St_)
$3\ddagger$	49G	= three-phase thermal overload protection for generator (TOL3Dev)
$3\ddagger$	49T	= three-phase thermal overload protection for transformers (TOL3Dev)
$\Theta >$	49 38	= thermal supervision for generator windings and bearings with RTDs (MEAI_)
CBFP	62BF	= circuit-breaker failure protection (included in all current-based short circuit and earth-fault protection function blocks)









SYMNOT1_RET

Fig. 13 Symbol notations, part I

<table border="1"><tr><td>Z<</td><td>21G</td></tr></table>	Z<	21G	= underimpedance protection for generator, low-set and high-set stages (UI6_)
Z<	21G		
<table border="1"><tr><td>3Z<</td><td>21</td></tr></table>	3Z<	21	= three-phase underimpedance protection, low-set and high-set stages (UI6_)
3Z<	21		
<table border="1"><tr><td>X<</td><td>40</td></tr></table>	X<	40	= underexcitation protection, low-set and high-set stages (UE6_)
X<	40		
<table border="1"><tr><td></td><td>32</td></tr></table>		32	= underpower, low-forward power or reverse power protection, stages 1, 2 and 3 available (UPOW6St_)
	32		
<table border="1"><tr><td></td><td>60</td></tr></table>		60	= fuse failure supervision (FuseFail)
	60		
<table border="1"><tr><td></td></tr></table>		= arc protection with REA 101	
			
<table border="1"><tr><td>MCS</td></tr></table>	MCS	= measuring circuit supervision	
MCS			
<table border="1"><tr><td>TCS</td></tr></table>	TCS	= trip circuit supervision	
TCS			
<table border="1"><tr><td>CBCM</td></tr></table>	CBCM	= circuit-breaker condition monitoring	
CBCM			
<table border="1"><tr><td></td><td>90V</td></tr></table>		90V	= automatic voltage regulation (COLTC)
	90V		
<table border="1"><tr><td></td></tr></table>		= manual voltage regulation (COLTC)	
			
<table border="1"><tr><td>P</td></tr></table>	P	= active power measurement, indication and supervision	
P			
<table border="1"><tr><td>Q</td></tr></table>	Q	= reactive power measurement, indication and supervision	
Q			
<table border="1"><tr><td>3I</td></tr></table>	3I	= 3-phase current measurement, indication and supervision	
3I			
<table border="1"><tr><td>3U</td></tr></table>	3U	= 3-phase voltage or phase-to-phase voltage measurement, indication and supervision	
3U			
<table border="1"><tr><td>f</td></tr></table>	f	= frequency measurement, indication and supervision	
f			
<table border="1"><tr><td>pf</td></tr></table>	pf	= power factor measurement, indication and supervision	
pf			
<table border="1"><tr><td>I₀</td></tr></table>	I ₀	= residual current measurement, indication and supervision	
I ₀			
<table border="1"><tr><td>U₀</td></tr></table>	U ₀	= residual voltage measurement, indication and supervision	
U ₀			

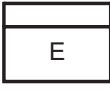
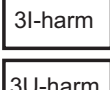
SYMNOT2_RET

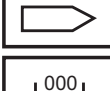
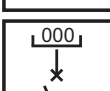
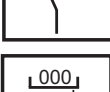
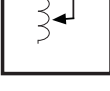
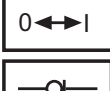
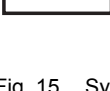
Fig. 14 Symbol notations, part II

	= phase voltage or phase-to-phase voltage measurement, indication and supervision
	= oil temperature measurement, indication and supervision
	= transformer winding temperature measurement, indication and supervision
	= tap changer temperature measurement, indication and supervision
	= ambient temperature measurement, indication and supervision
	= energy counter, forward or reverse active / reactive energy (MEPE7)
	= current waveform distortion measurement (PQCU3H)
	= voltage waveform distortion measurement (PQVU3H)
	= annunciating, event generating and value recording functions
	= disturbance recorder (MEDREC16)
	= digital value indication
	= HMI/MIMIC display
	= tap changer position display
	= local and remote control interface
	= bay-oriented interlocking logic

SYMNOT3_RET

Fig. 15 Symbol notations, part III

Application selection tables for RET 541, RET 543 and RET 545 functions

Table 30: Protection functions

Types of fault	IEEE Device No.	IEC Symbol	Protection function	Function block code
Differential protection	87T	$3\Delta I>, 3\Delta I>>$	Stabilized and instantaneous differential protection for transformers	Diff6T
Short circuit and overcurrent	51	$3I>$	Three-phase non-directional overcurrent, low-set stage	NOC3Low
	51	$3I>$	Three-phase non-directional overcurrent, low-set stage	NOC3LowB
	50/51/51B	$3I>>$	Three-phase non-directional overcurrent, high-set stage	NOC3High
	50/51B	$3I>>>$	Three-phase non-directional overcurrent, instantaneous stage	NOC3Inst
	67	$3I>\rightarrow$	Three-phase directional o/c, low-set stage	DOC6Low
	67	$3I>>\rightarrow$	Three-phase directional o/c, high-set stage	DOC6High
	67	$3I>>>\rightarrow$	Three-phase directional o/c, instantaneous stage	DOC6Inst
Underimpedance	21	$Z<$	Three-phase underimpedance, low-set stage	UI6Low
	21	$Z<<$	Three-phase underimpedance, high-set stage	UI6High
Earth fault	51N	$Io>/SEF$	Non-directional earth-fault, low-set stage (or SEF = sensitive earth-fault protection)	NEF1Low
	50N/51N	$Io>>$	Non-directional earth-fault, high-set stage	NEF1High
	50N	$Io>>>$	Non-directional earth-fault, instantaneous stage	NEF1Inst
	67N/51N	$Io>\rightarrow/SEF$	Directional earth-fault, low-set stage (or SEF = sensitive earth-fault protection)	DEF2Low
	67N	$Io>>\rightarrow$	Directional earth-fault, high-set stage	DEF2High
	67N	$Io>>>\rightarrow$	Directional earth-fault, instantaneous stage	DEF2Inst
	59N	$Uo>$	Residual overvoltage, low-set stage	ROV1Low
	59N	$Uo>>$	Residual overvoltage, high-set stage	ROV1High
	59N	$Uo>>>$	Residual overvoltage, instantaneous stage	ROV1Inst
	87N	$\Delta Io>$	High-impedance based restricted earth-fault protection	REF1A

Table 30: Protection functions

Types of fault	IEEE Device No.	IEC Symbol	Protection function	Function block code
Earth-fault	87TN	$\Delta I_0 >$	Stabilized restricted earth-fault protection	REF4A
	87TN	$\Delta I_0 >$	Stabilized restricted earth-fault protection	REF4B
Overload	49M/49G/49T	3	Three-phase thermal protection for devices (motors, generators and transformers)	TOL3Dev
Negative phase-sequence	46	$I_2 >$	Negative phase-sequence protection, low-set stage	NPS3Low
	46	$I_2 >>$	Negative phase-sequence protection, high-set stage	NPS3High
Overvoltage/undervoltage	59	$3U >$	Three-phase overvoltage, low-set stage	OV3Low
	59	$3U >>$	Three-phase overvoltage, high-set stage	OV3High
	27	$3U <$	Three-phase undervoltage, low-set stage	UV3Low
	27	$3U <<$	Three-phase undervoltage, high-set stage	UV3High
	27, 47, 59	$U_1 <$ $U_2 >$ $U_1 >$	Phase-sequence voltage protection, stage 1	PSV3St1
	27, 47, 59	$U_1 <$ $U_2 >$ $U_1 >$	Phase-sequence voltage protection, stage 2	PSV3St2
Overfrequency/underfrequency	81U/81O	$f </f>$, df/dt	Underfrequency or overfrequency, stage 1 (incl. rate of change)	Freq1St1
	81U/81O	$f </f>$, df/dt	Underfrequency or overfrequency, stage 2 (incl. rate of change)	Freq1St2
	81U/81O	$f </f>$, df/dt	Underfrequency or overfrequency, stage 3 (incl. rate of change)	Freq1St3
	81U/81O	$f </f>$, df/dt	Underfrequency or overfrequency, stage 4 (incl. rate of change)	Freq1St4
	81U/81O	$f </f>$, df/dt	Underfrequency or overfrequency, stage 5 (incl. rate of change)	Freq1St5
Overexcitation	24	$U/f >$	Overexcitation protection, low-set stage	OE1Low
	24	$U/f >>$	Overexcitation protection, high-set stage	OE1High
Additional functions	68	$3I_{2f} >$	Three-phase transformer inrush and motor start-up current detector	Inrush3
	60	FUSEF	Fuse failure supervision	FuseFail

Table 31: Measurement functions

Types of measurement	IEC Symbol	Measurement function	Function block code
General measurement/ analog input or analog output	$mA/V/^{\circ}C/\Omega$	General measurement/ analog input on RTD/analog module	MEAI1...8
	mA	Analog output on RTD/analog module	MEAO1...4
Current	3I	Three-phase current measurement, stage A	MECU3A
	3I	Three-phase current measurement, stage B	MECU3B
	Io	Neutral current measurement, stage A	MECU1A
	Io	Neutral current measurement, stage B	MECU1B
Voltage	3U	Three-phase voltage measurement, stage A	MEVO3A
	3U	Three-phase voltage measurement, stage B	MEVO3B
	Uo	Residual voltage measurement, stage A	MEVO1A
	Uo	Residual voltage measurement, stage B	MEVO1B
Energy / Power	E, P, Q, pf	Three-phase power and energy measurement	MEPE7
Frequency	f	System frequency measurement	MEFR1
Recording		Transient disturbance recorder	MEDREC16

Table 32: Control functions

Types of control	Symbol	Control function	Function block code
Circuit breaker	0 ↔ 1	Circuit breaker 1 (2 state inputs / 2 control outputs)	COCB1
	0 ↔ 1	Circuit breaker 2 (2 state inputs / 2 control outputs)	COCB2
	0 ↔ 1	Direct open for CBs via HMI	COCBDIR
Disconnecter	0 ↔ 1	Disconnecter 1...5 (2 state inputs / 2 control outputs)	CODC1...CODC5
	0 ↔ 1	Three state disconnecter 1 (3 state inputs/ 4 control outputs)	CO3DC1
	0 ↔ 1	Three-state disconnecter 2 (3 state inputs/ 4 control outputs)	CO3DC2

Table 32: Control functions

Types of control	Symbol	Control function	Function block code
Other control functions		Object indication 1...8 (2 state inputs)	COIND1...COIND8
		On/off switch 1...4 (1 output)	COSW1...COSW4
		Logic control position selector	COLOCAT
		On-load tap changer controller (voltage regul.)	COLTC
		MIMIC dynamic data point 1...5	MMIDATA1...MMIDATA5
		Alarm 1...8 (HMI, remote)	MMIALAR1...MMIALAR8

Table 33: Condition monitoring functions

Types of condition monitoring	Symbol	Condition monitoring function	Function block code
Circuit breaker	CBCM	CB electric wear 1	CMBWEAR1
	CBCM	CB electric wear 2	CMBWEAR2
	CBCM	Operate time counter 1 for used operate time (motors)	CMTIME1
	CBCM	Operate time counter 2 for used operate time (motors)	CMTIME2
	CBCM	Gas pressure monitoring	CMGAS1
	CBCM	Three-pole gas pressure monitoring	CMGAS3
	CBCM	Spring charging control 1	CMSPRC1
	CBCM	Breaker travel time 1	CMTRAV1
	CBCM	Scheduled maintenance	CMSCHED
Trip circuit	TCS	Trip Circuit Supervision 1	CMTCS1
	TCS	Trip Circuit Supervision 2	CMTCS2
Measuring circuit	MCS	Supervision function of the energizing current input circuit	CMCU3
	MCS	Supervision function of the energizing voltage input circuit	CMVO3

References

Additional information

Transformer Terminal RET 54_ Technical Reference Manual, General	1MRS755225
Technical Descriptions of Functions	1MRS750889-MCD (CD-ROM only)
Installation Manual	1MR 750526-MUM
Operator's Manual	1MR 750500-MUM
Technical Reference Manual RER 103	1MRS750532-MUM
Technical Reference Manual RER 123	1MRS751143-MUM
Protection & Control Terminals REF 54_, REM 54_, RET 54_ and REC 523 Configuration Guideline	1MRS750745-MUM
Bus Connection Module RER 133 Technical Description	1MRS755163

Echelon, LON and LonTalk are registered trademarks of Echelon Corporation.

All other product names or brands are trademarks, registered trademarks, or service marks of their respective owners.

Document changes

Version	Date	Changes
C	15.06.2005	Table 7: Reset ratio of OV3Low and OV3High changed from 0.96 to 1.04
D	28.05.2010	Document updated
E	26.10.2010	Document updated



ABB Oy
Distribution Automation
P.O. Box 699
FI-65101 Vaasa, FINLAND
Tel +358 10 22 11
Fax +358 10 224 1094
www.abb.com/substationautomation