

TECHNICAL SPECIFICATION

Type designation: **AMG 0355BL04**
Application: Diesel/Gas engine Industrial Application Series
Site criteria: Land use

NOTES



CONTENTS

SECTION:

| | | |
|----------|--|-----------|
| 1 | <i>PERFORMANCE DATA (Calculated values)</i> | 2 |
| 2 | <i>PERFORMANCE CURVES</i> | 3 |
| 3 | <i>CONFIGURATION AND SCOPE OF SUPPLY</i> | 7 |
| 4 | <i>ACCESSORIES</i> | 10 |
| 5 | <i>MAIN DIMENSIONS</i> | 11 |

*Type definition:

AMG0355BL04 DBS

IC/IP combination 
 Bearing type 
 Excitation type 

Bearing type: A-Double bearing, B-Single bearing
 Excitation type: S-Shunt, A-Auxiliary winding, P-PMG

| | | | | | |
|--|-----------|---|-------------|----------------|------------|
| Prep. PE.YA | 29.8.2011 | TECHNICAL SPECIFICATION | | | No. of sh. |
| Appr. TU.TU | 29.8.2011 | | | | 12 |
| Resp. dept. R&D | | | | | |
|  ABB Generators Ltd. | | Document identification 8AMG 5862151 | Lang. en | Rev. ind. A | Sheet 1 |

1 PERFORMANCE DATA (Calculated values)

TYPE

Type designation: AMG 0355BL04

PERFORMANCE DATA

| | | | | | | | | |
|--|---|---------|---------|---------|------------------------------|---------|---------|---------|
| Main standard | IEC 60034 | | | | | | | |
| Rated power factor | 0.8 | | | | | | | |
| Insulation class | H | | | | | | | |
| Temperature rise | H | | | | | | | |
| Ambient temperature | 40 °C | | | | | | | |
| Altitude over sea level | ≤ 1000 m | | | | | | | |
| Cooling/Protection | IC0A1/IP23 | | | | | | | |
| | Single bearing | | | | Double bearing | | | |
| Mounting arrangement | IM 2105 | | | | IM 1001 | | | |
| Weight without/with PMG | 1505/1530 kg | | | | 1545/1570 kg | | | |
| Inertia without/with PMG | 11.10/11.11 kgm ² | | | | 10.67/10.68 kgm ² | | | |
| Direction of rotation | CW (Facing drive end) | | | | | | | |
| Maximum overspeed | 2250 rpm | | | | | | | |
| Winding pitch | Two thirds (2/3) | | | | | | | |
| Stator winding resistance | 0.00446 Ω per phase at 20°C series star connection | | | | | | | |
| Rotor winding resistance | 2.065 Ω at 20°C | | | | | | | |
| Ex. stator winding resistance | 15.16 Ω at 20°C | | | | | | | |
| Ex. rotor winding resistance | 0.157 Ω at 20°C | | | | | | | |
| Total Harmonic Distortion | At no load <2.5%, at rated Linear balanced load <5% | | | | | | | |
| Voltage regulation | ±1 % | | | | | | | |
| Frequency | 50 Hz | | | | 60 Hz | | | |
| Telephone Interference | THF <2% | | | | TIF <50 | | | |
| Speed | 1500 rpm | | | | 1800 rpm | | | |
| Cooling Air | 0.70 m ³ /sec | | | | 0.84 m ³ /sec | | | |
| Voltage series star 3ph. | 380/220 | 400/231 | 415/240 | 440/254 | 415/240 | 440/254 | 460/266 | 480/277 |
| Voltage parallel star 3ph. | 190/110 | 200/115 | 208/120 | 220/127 | 208/120 | 220/127 | 230/133 | 240/138 |
| Voltage series delta 3ph. | 220 | 230 | 240 | 254 | 240 | 254 | 266 | 277 |
| Voltage parallel delta 3ph. | 110 | 115 | 120 | 127 | 120 | 127 | 133 | 138 |
| Rated continuous output | 595 kVA | 625 kVA | 625 kVA | 595 kVA | 660 kVA | 700 kVA | 735 kVA | 765 kVA |
| Rated efficiency | 94.37% | 94.46% | 94.58% | 94.76% | 94.65% | 94.80% | 94.88% | 94.96% |
| X _d (u) | 4.255 | 4.034 | 3.747 | 3.174 | 4.749 | 4.480 | 4.304 | 4.114 |
| X _d (s) | 3.300 | 2.934 | 2.551 | 1.863 | 3.930 | 3.582 | 3.308 | 2.992 |
| X _q (u) | 1.980 | 1.877 | 1.744 | 1.477 | 2.210 | 2.085 | 2.003 | 1.915 |
| X' _d (u) | 0.290 | 0.275 | 0.255 | 0.216 | 0.323 | 0.305 | 0.293 | 0.280 |
| X' _d (s) | 0.264 | 0.250 | 0.232 | 0.196 | 0.294 | 0.277 | 0.266 | 0.255 |
| X'' _d (u) | 0.193 | 0.182 | 0.168 | 0.140 | 0.217 | 0.204 | 0.195 | 0.186 |
| X'' _d (s) | 0.175 | 0.165 | 0.153 | 0.127 | 0.197 | 0.185 | 0.177 | 0.169 |
| X'' _q (u) | 0.212 | 0.201 | 0.186 | 0.158 | 0.236 | 0.223 | 0.214 | 0.204 |
| X'' _q (s) | 0.192 | 0.182 | 0.169 | 0.143 | 0.214 | 0.202 | 0.194 | 0.186 |
| X ₁ (u) | 0.092 | 0.087 | 0.081 | 0.069 | 0.103 | 0.097 | 0.093 | 0.089 |
| X ₂ (u) | 0.202 | 0.191 | 0.177 | 0.149 | 0.226 | 0.213 | 0.204 | 0.195 |
| X ₂ (s) | 0.184 | 0.174 | 0.161 | 0.135 | 0.206 | 0.194 | 0.186 | 0.177 |
| X ₀ (u) | 0.029 | 0.027 | 0.025 | 0.021 | 0.032 | 0.030 | 0.029 | 0.028 |
| X _p (s) | 0.218 | 0.206 | 0.191 | 0.162 | 0.206 | 0.229 | 0.220 | 0.210 |
| SCR (short circuit ratio), I _{r0} /X _d (u) | 0.30 | 0.34 | 0.39 | 0.54 | 0.25 | 0.28 | 0.30 | 0.33 |
| s=saturated value, u=unsaturated value, values are p.u. at rated voltage and power | | | | | | | | |
| T _{d0} ' | 3.912 s | | | | | | | |
| T _d ' | 0.170 s | | | | | | | |
| T _d '' | 0.0142 s | | | | | | | |
| T _a | 0.0293 s | | | | | | | |
| CE-Marking | Generator fulfills the requirements of Low Voltage Directive (2006/95/EC) Generator supplied to EEA-area will be CE-marked | | | | | | | |

| | | | | | |
|---|----------------------------|-------------------------|-------|-----------|-------|
|  | ABB Generators Ltd. | Document identification | Lang. | Rev. ind. | Sheet |
| | | 8AMG 5862151 | en | A | 2 |

2 PERFORMANCE CURVES

THREE PHASE EFFICIENCY CURVES, 50 Hz/380–440 V



ABB Generators Ltd.

Document identification

8AMG 5862151

Lang.

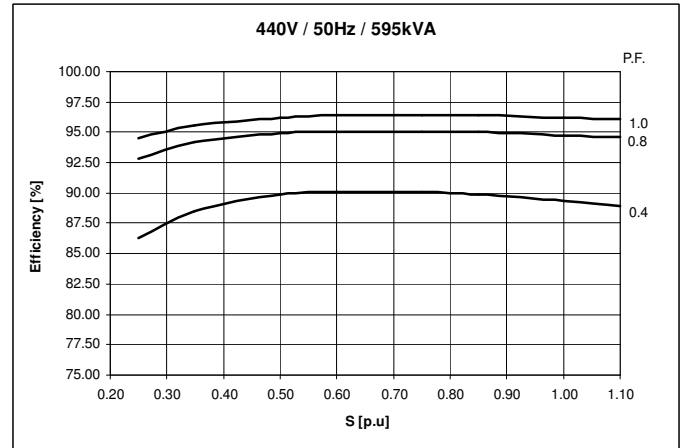
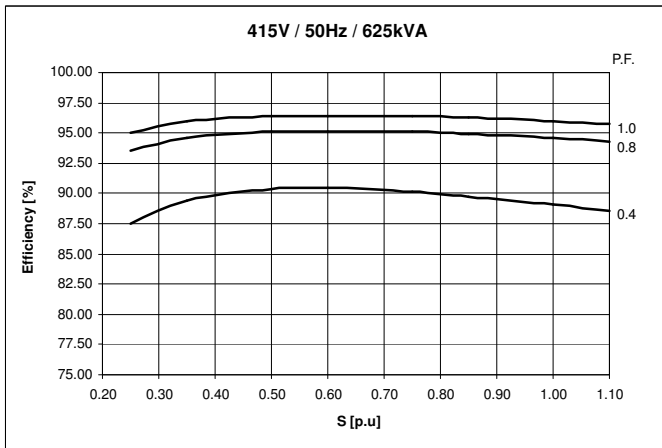
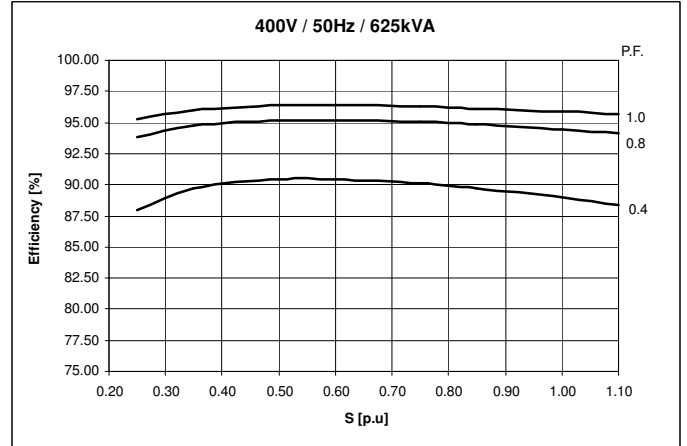
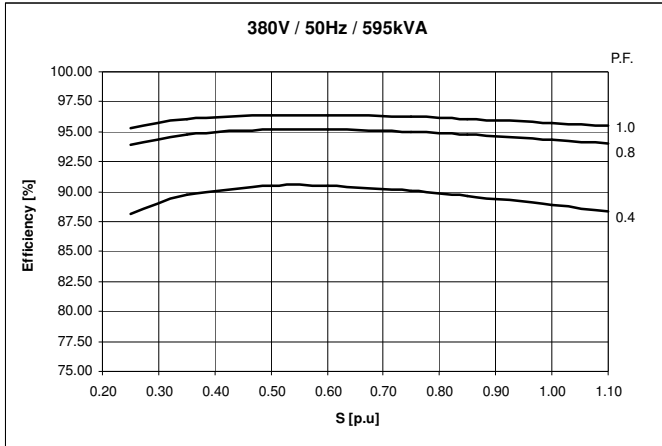
en

Rev. ind.

A

Sheet

3

THREE PHASE EFFICIENCY CURVES, 60 Hz/415–480 V



ABB Generators Ltd.

Document identification

8AMG 5862151

Lang.

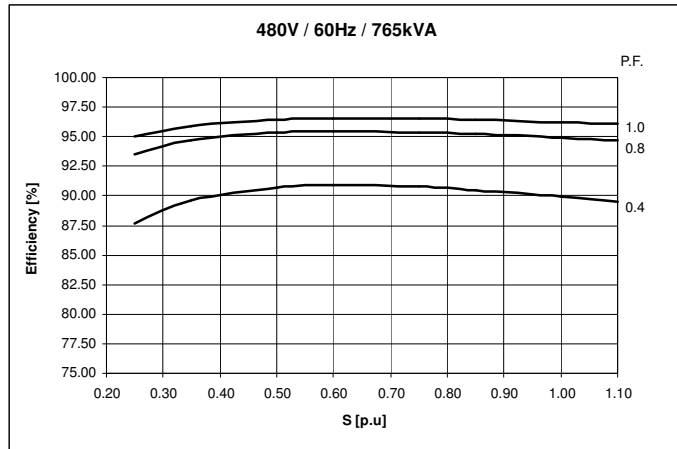
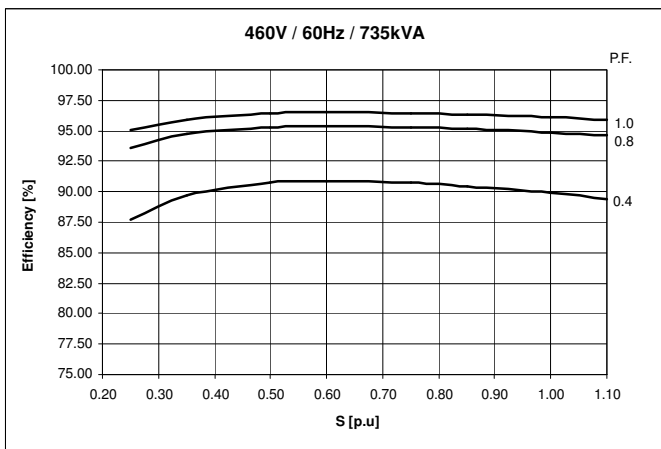
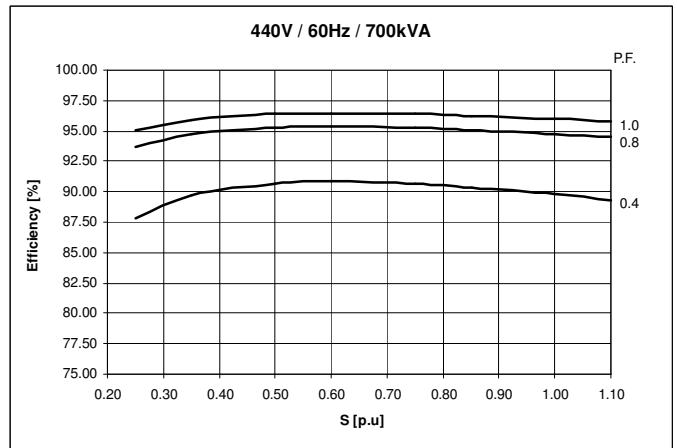
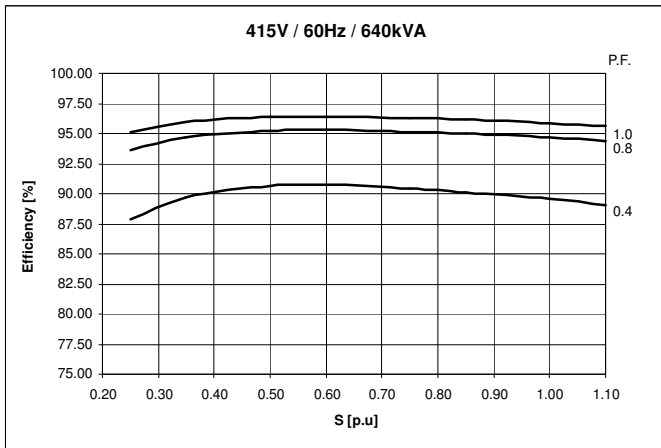
en

Rev. ind.

A

Sheet

4

TRANSIENT VOLTAGE REGULATION CURVES

Load application (Shunt excitation):

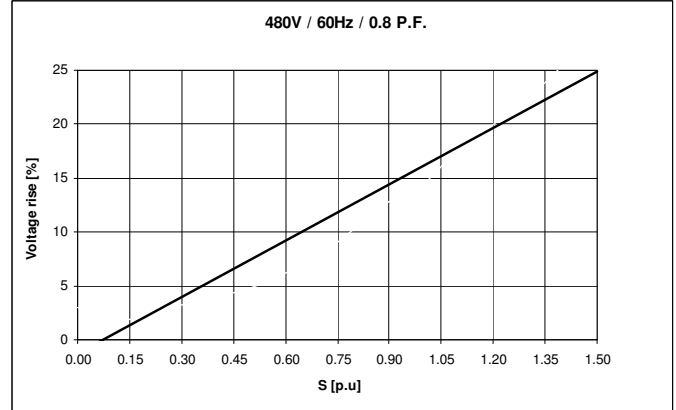
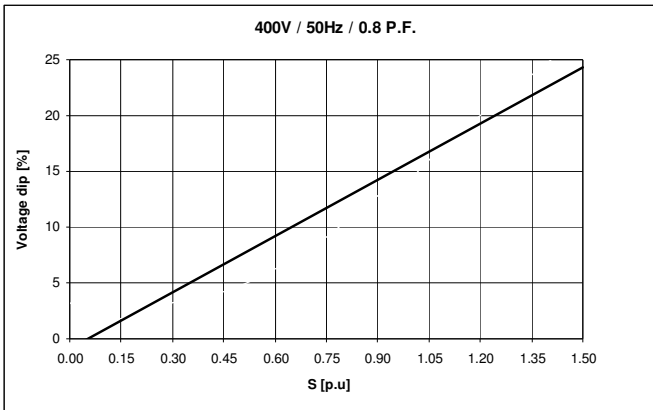

Load application (Auxiliary winding or PMG excitation):

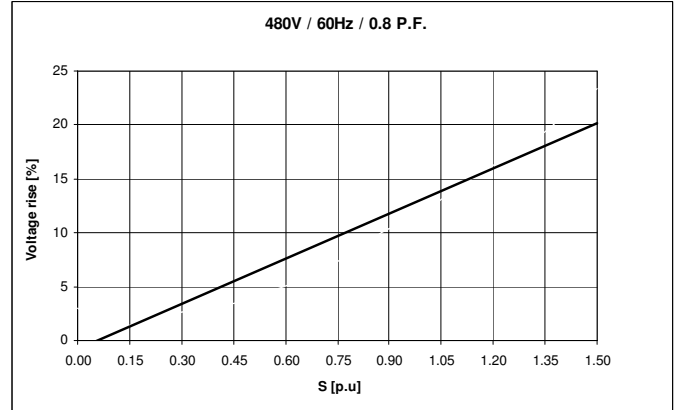
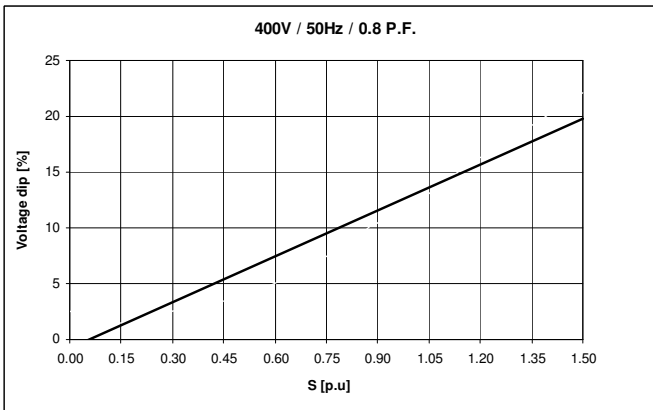

Load rejection (Shunt excitation):



ABB Generators Ltd.

Document identification
8AMG 5862151

| Lang. | Rev. ind. | Sheet |
|-------|-----------|-------|
| en | A | 5 |

TRANSIENT VOLTAGE REGULATION CURVES

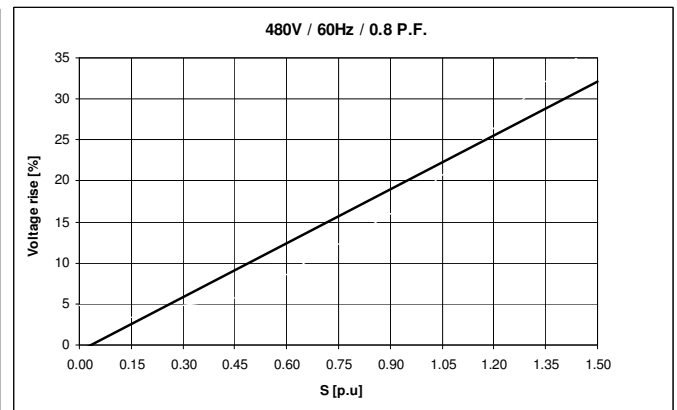
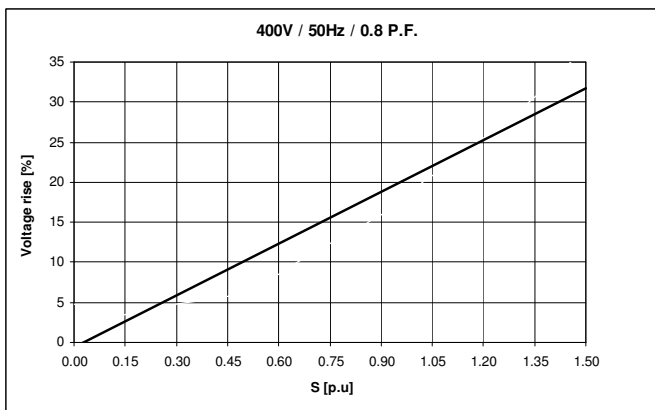
Load rejection (Auxiliary winding or PMG excitation):

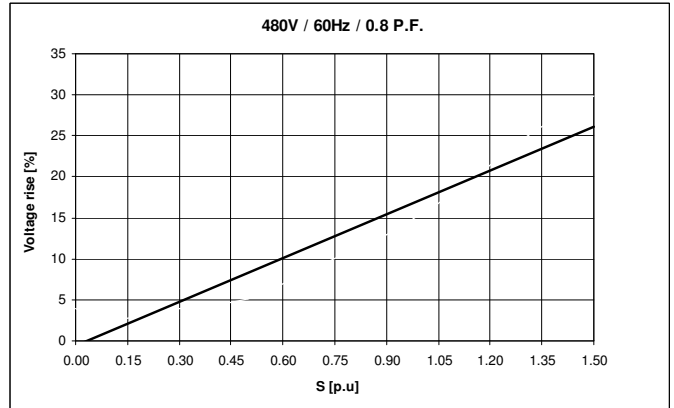
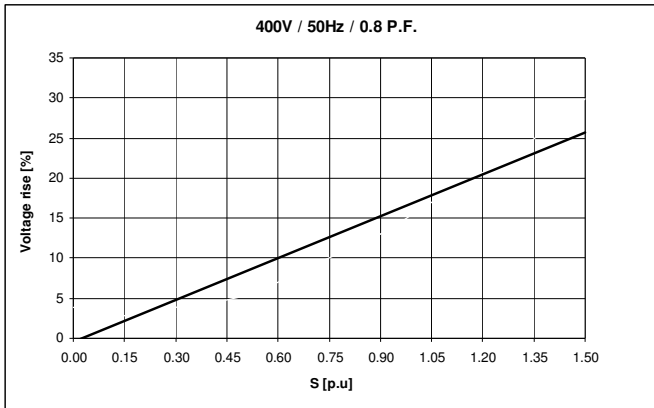

Locked Rotor Motor Starting Curve (Shunt excitation):

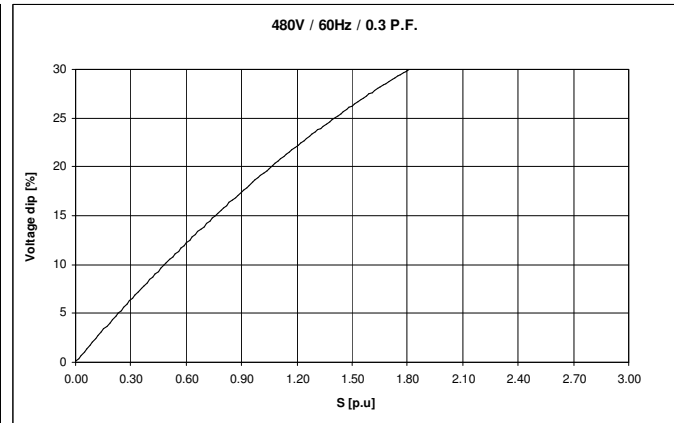
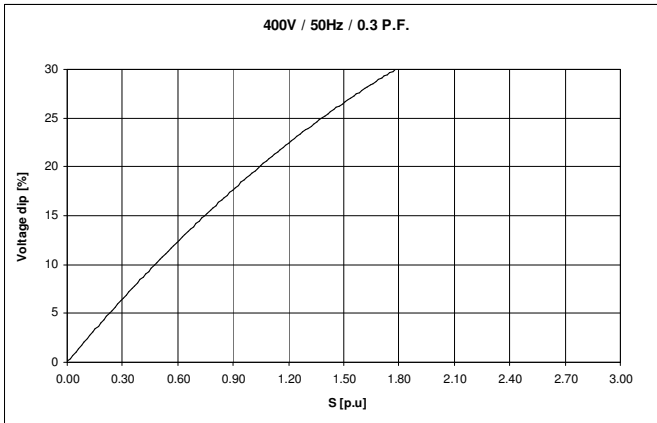

Locked Rotor Motor Starting Curve (Auxiliary winding or PMG excitation):

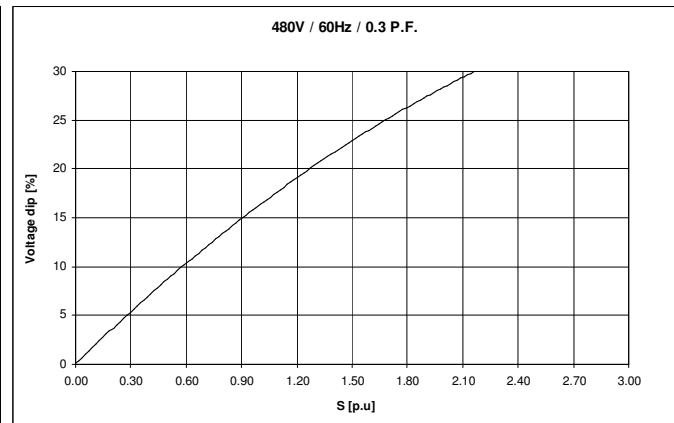
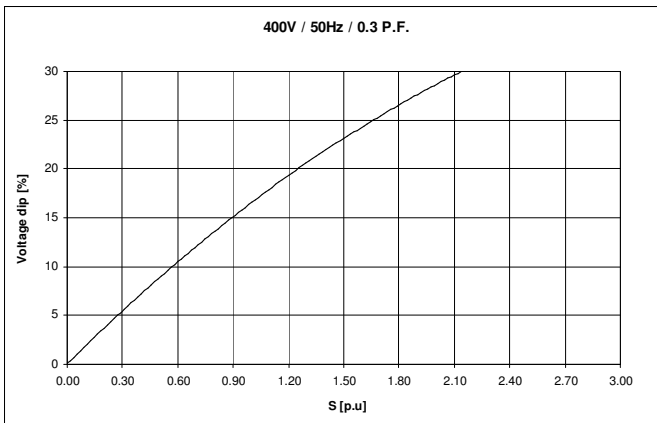

Note1

S [P.U] =S/S(Rated), S stands for the actual operation capacity, S(Rated) stands for the generator rated output capacity.



ABB Generators Ltd.

Document identification

8AMG 5862151

Lang.

en

Rev. ind.

A

Sheet

6

3 CONFIGURATION AND SCOPE OF SUPPLY

GENERAL

The generator is designed to operate together with a diesel or gas engine.

CONSTRUCTION

The stator frame is a rigid welded steel structure construction. The stator core is built of thin electric sheet steel laminations which are insulated on both sides with heat-resistant inorganic resin.

The rotor consists of a shaft and a star shape rotor core. The shaft is machined of rolled steel. Special heat treatment is used if shaft operates under heavy conditions. The poles are manufactured of 0.5 mm sheet steel. The pole laminations are pressed and welded together with steel bars. These bars are then welded to the end plates. Rotor balancing is done acc. to ISO 1940/1. The standard balancing quality grade is G2.5.

All windings are completely vacuum pressure impregnated with high quality resin. The windings are provided with very strong bracing which withstands all expected mechanical and electrical shocks and vibrations as well as chemicals.

End shields are made of casted steel, The stator frame and stator core are welded together, and bolted with end shields.

MAIN TERMINAL SPACE

Protection class IP44, Integrated into the top module of the generator.

Supply cable entries: Closed terminal box. Cable inlet to the main terminal box to be done by the customer.

Twelve (12) leads T1 – T12 brought into the terminal box to enable internal series star, parallel star, series delta and parallel delta connection, Main terminals U, V, W and neutral point N in the main terminal box for external connection

Terminal marking acc. to IEC.

Max. internal air temperature 60 °C.

Designed for continuous current load.

FOUNDATION

The machine can be mounted using shimming, machined blocks, chock fast or on grouted sole plates or bed plate. Before using other mountings, contact us.

CONTROL SYSTEMS

General

Brushless excitation.

Automatic Voltage Regulator System

Mounted inside the main terminal box.

Analog type AVR.

Functions:

- a) 1-channel AVR.
- b) Excitation power can be from phase voltage of main terminal or auxiliary winding, PMG.
- c) Voltage set-point adjustment (local).
- d) U/f limiter.
- e) Parallel operation.



ABB Generators Ltd.

Document identification

8AMG 5862151

Lang.

en

Rev. ind.

A

Sheet

7

Static voltage regulation accuracy +/- 1.0 %.

Voltage recovery time after transient < 1.5 s, +/- 3.0 % (acc. to IEC 60034).

Nominal U_m , range: < 90 VDC at 110 VAC input, 170 VDC at 220 VAC input.

Nominal I_m , range: continuous 5 ADC.

BEARINGS

Non Drive-end: Rolling, sealed for life, free. Drive-end: Rolling, w/grease, locked. (Double bearing)

Life time: $L_{10} \geq 30\,000$ h.

Not electrically insulated.

Calculated maximum bearing temperature 95 °C at ambient 40 °C.

TESTING

Testing is according to IEC and ABB internal requirements. The test may be observed by the customer without extra charges. The test procedures are described in the following documents which are available on request:

-Routine tests: MDD 8006327 (for all machines).

-Type tests: MDD 8006328 (optional, to be agreed separately).

-Special tests: MDD 8006329 (optional, to be agreed separately).

PERFORMANCE CHARACTERISTICS AND OPERATIONAL LIMITS

Rating for continuous running duty:

Duty type S1.

Rating for short-time duty:

10 % overload at nominal power factor for one hour at twelve hour intervals.

50 % overload at nominal power factor for two minutes at twelve hour intervals.

Overcurrent withstand capability:

3 times nominal current for 10 s.

Generator shall be suitable for supplying circuits which, when supplied by a system of balanced and sinusoidal voltages:

Result in currents not exceeding a harmonic current factor of 0,05 and

Result in a system of currents where neither the negative-sequence component nor the zero-sequence component exceed 5% of the positive-sequence component

Maximum voltage unbalance is 0.5 %.

Maximum I_2/I_N value for continuous operation is 8 %.

Maximum $(I_2/I_N)^2 \times t$ in seconds for operation under fault conditions is 20

Maximum continuous voltage variation with rated output is ± 5 %.

Maximum continuous frequency variation with rated output is ± 2 %.

Maximum combined voltage and frequency variation and maximum short-time limits are acc. To IEC 60034-1:2004, Section 7.3.

Electromagnetic Compatibility (EMC)

Radiated and conducted emissions comply with the requirements of CISPR 11, Class B, Group 1, Table B.1. (IEC 60034-1, Annex B).

TOLERANCES

Efficiency η

Machines up to and including 150 kW (or kVA) -15 % of $(1-\eta)$



ABB Generators Ltd.

Document identification

8AMG 5862151

Lang.

en

Rev. ind.

A

Sheet

8

| | |
|---|--|
| Machines above 150 kW (or kVA) | -10 % of (1- η) |
| Total losses (applicable to machines with ratings >150 kW or kVA) | +10 % of the total losses |
| Peak value of short-circuit current under specified conditions | ± 30 % of the value in the technical specification |
| Steady short-circuit current at specified excitation | ± 15 % of the value in the technical specification |
| Moment of inertia | ± 10 % of the value in the technical specification |

SURFACE TREATMENT

Grade: C2, Standard color

Surface treatment C2 according to the ISO 12944 standard, for standard industrial environment.

| | | | | | |
|---|----------------------------|-------------------------|-------|-----------|-------|
|  | ABB Generators Ltd. | Document identification | Lang. | Rev. ind. | Sheet |
| | | 8AMG 5862151 | en | A | 9 |

4 ACCESSORIES

OPTIONAL ACCESSORIES

| No pc/pcs | Item | Note |
|-----------|--------------------------|--|
| 2 | Anti-condensation heater | |
| 1 | Current transformer | For parallel operation with other generators |
| 6 | PT100 for stator winding | |
| 1 | PTC sensor (triple) | |
| 1 | PMG | |



ABB Generators Ltd.

Document identification

8AMG 5862151

Lang.

en

Rev. ind.

A

Sheet

10

5 MAIN DIMENSIONS

SINGLE BEARING

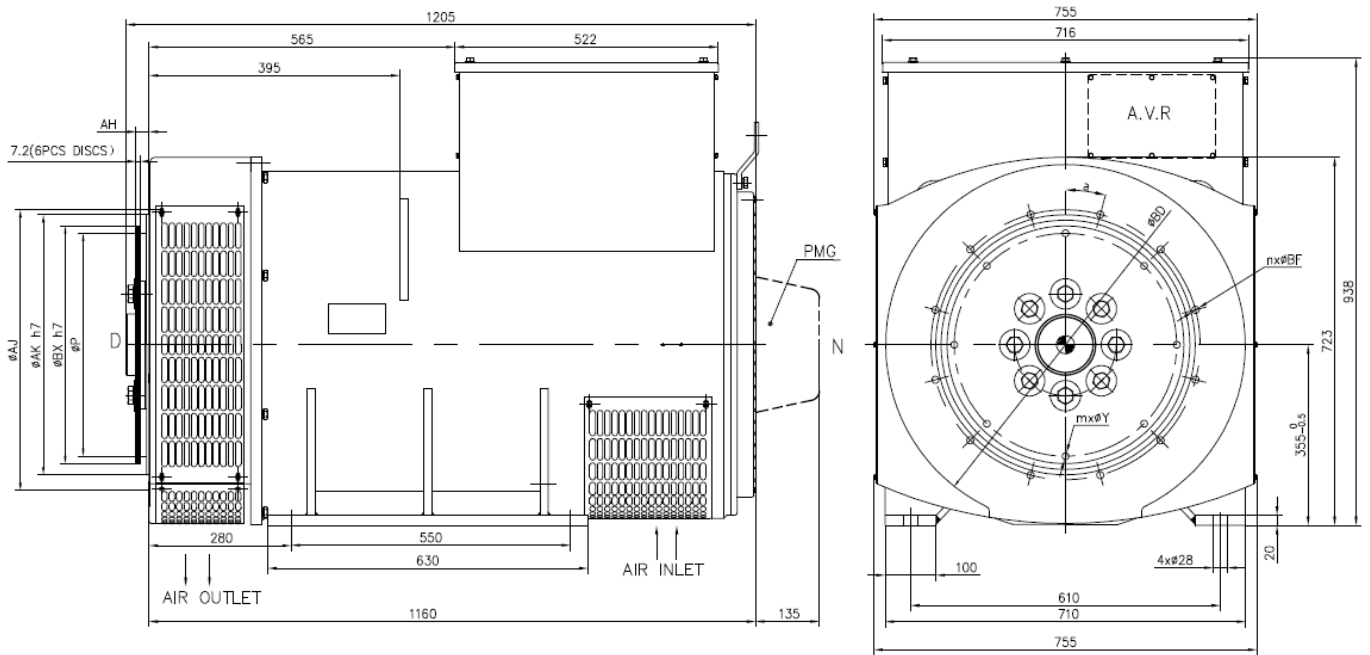

Flange dimensions

| S.A.E | AK | AJ | BD | BF | n | a |
|-------|--------|--------|-----|----|----|---------|
| 1 | 511.18 | 530.2 | 708 | 14 | 12 | 15 ° |
| 1/2 | 584.2 | 619.25 | 708 | 14 | 12 | 15 ° |
| 0 | 647.7 | 679.45 | 708 | 14 | 16 | 11.25 ° |

Flex disc dimensions

| S.A.E | BX | P | AH | Y | m |
|--------|--------|--------|------|------|---|
| 11 1/2 | 352.43 | 333.38 | 39.6 | 11 | 8 |
| 14 | 466.72 | 438.15 | 25.4 | 13.5 | 8 |
| 18 | 571.50 | 542.92 | 15.7 | 18 | 6 |



ABB Generators Ltd.

Document identification
8AMG 5862151

| Lang. | Rev. ind. | Sheet |
|-------|-----------|-------|
| en | A | 11 |

