

TECHNICAL SPECIFICATION

Type designation: **AMG 0400ES04**
Application: Diesel/Gas Engine Industrial Application Series
Site criteria: Land use

NOTES

CONTENTS

SECTION:

1	<i>PERFORMANCE DATA (Calculated values)</i>	2
2	<i>PERFORMANCE CURVES</i>	3
3	<i>CONFIGURATION AND SCOPE OF SUPPLY</i>	6
4	<i>ACCESSORIES</i>	9
5	<i>MAIN DIMENSIONS</i>	10

*Type definition:

AMG0400ES04 DBA

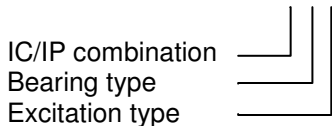

Bearing type: A-Double bearing, B-Single bearing
 Excitation type: A-Auxiliary winding, P-PMG

Prep. PE.YA	29.8.2011	TECHNICAL SPECIFICATION			No. of sh.
Appr. TU.TU	29.8.2011				11
Resp. dept. R&D					
ABB ABB Generators Ltd.		Document identification 8AMG 5861260	Lang. en	Rev. ind. B	Sheet 1



ABB Generators Ltd.

Document identification

8AMG 5861260

Lang.

en

Rev. ind.

B

Sheet

2

1 PERFORMANCE DATA (Calculated values)

TYPE

Type designation: AMG 0400ES04

PERFORMANCE DATA

Main standard	IEC 60034							
Rated power factor	0.8							
Insulation class	H							
Temperature rise	H							
Ambient temperature	40 °C							
Altitude over sea level	≤ 1000 m							
Cooling/Protection	IC0A1/IP23							
	Single bearing				Double bearing			
Mounting arrangement	IM 2105				IM 1001			
Weight without/with PMG	2700/2715 kg				2750/2765 kg			
Inertia (no diff. with PMG)	22.1 kgm ²				20.7 kgm ²			
Direction of rotation	CW (Facing drive end)							
Maximum overspeed	2250 rpm							
Winding pitch	Two thirds (2/3)							
Stator winding resistance	0.00167 Ω per phase at 20 °C series star connection							
Rotor winding resistance	0.603 Ω at 20 °C							
Ex. stator winding resistance	17.308 Ω at 20 °C							
Ex. rotor winding resistance	0.0452 Ω at 20 °C							
Total Harmonic Distortion	THD<3.5% at no load operation or rated Linear balanced load							
Voltage regulation	±1 %							
Frequency	50 Hz				60 Hz			
Telephone Interference	THF<2%				TIF<50			
Speed	1500 rpm				1800 rpm			
Cooling Air	1.28 m ³ /sec				1.53 m ³ /sec			
Voltage series star 3 ph.	380/220	400/231	415/240	440/254	415/240	440/254	460/266	480/277
Voltage series delta 3 ph.	220	230	240	254	240	254	266	277
Rated continuous output	1190 kVA	1250 kVA	1250 kVA	1190 kVA	1300 kVA	1375 kVA	1440 kVA	1500 kVA
Rated efficiency	95.20%	95.26%	95.33%	95.45%	95.46%	95.58%	95.65%	95.68%
X _d (u)	3.479	3.298	3.064	2.595	3.824	3.598	3.448	3.298
X _d (s)	2.869	2.563	2.189	1.595	3.39	3.066	2.82	2.53
X _q (u)	1.544	1.463	1.36	1.151	1.697	1.596	1.53	1.463
X' _d (u)	0.283	0.269	0.25	0.211	0.311	0.293	0.281	0.269
X' _d (s)	0.257	0.245	0.227	0.192	0.283	0.266	0.255	0.245
X'' _d (u)	0.188	0.178	0.164	0.137	0.208	0.195	0.186	0.178
X'' _d (s)	0.171	0.162	0.149	0.125	0.189	0.177	0.169	0.162
X'' _q (u)	0.205	0.194	0.18	0.153	0.225	0.212	0.203	0.194
X'' _q (s)	0.186	0.177	0.164	0.139	0.204	0.192	0.184	0.176
X ₁ (u)	0.109	0.103	0.096	0.081	0.12	0.113	0.108	0.103
X ₂ (u)	0.196	0.186	0.172	0.145	0.216	0.203	0.194	0.186
X ₂ (s)	0.179	0.169	0.157	0.132	0.197	0.185	0.177	0.169
X ₀ (u)	0.028	0.027	0.025	0.021	0.031	0.03	0.028	0.027
X _p (s)	0.212	0.202	0.188	0.158	0.233	0.22	0.211	0.202
SCR (short circuit ratio), I _{r0} /X _d (u)	0.35	0.39	0.46	0.63	0.29	0.33	0.35	0.40
s=saturated value, u=unsaturated value, values are p.u. at rated voltage and power.								
T _{d0} '	3.739 s							
T _d '	0.239 s							
T _d ''	0.020 s							
T _a	0.0361 s							
CE-Marking	Generator fulfills the requirements of Low Voltage Directive (2006/95/EC) Generator supplied to EEA-area will be CE-marked							

	ABB Generators Ltd.	Document identification	Lang.	Rev. ind.	Sheet
		8AMG 5861260	en	B	3

TEMPLATE: TECHNICALSPECIFICATION.DOT; FILENAME: 5861260-B-AMG 0400ES04 TECHNICAL SPECIFICATION.DOC; PRINTDATE: 9/14/2011 1:14:00 PM; SAVEDATE: 9/7/2011 5:13:00 PM

2 PERFORMANCE CURVES

THREE PHASE EFFICIENCY CURVES, 50 Hz/380–440 V



ABB Generators Ltd.

Document identification

8AMG 5861260

Lang.

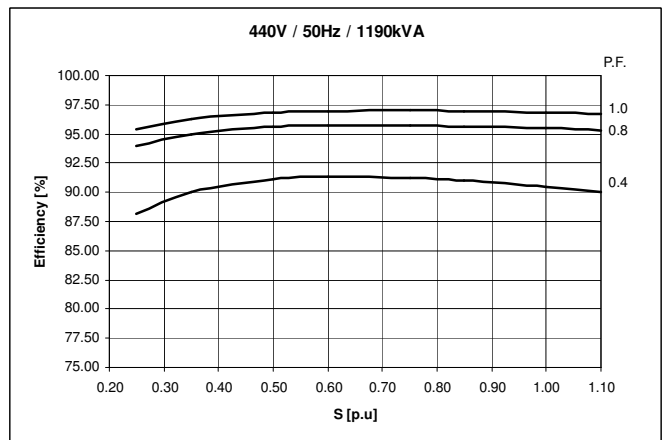
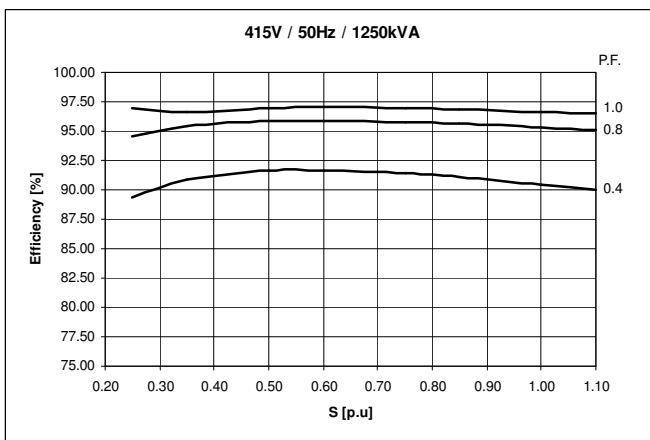
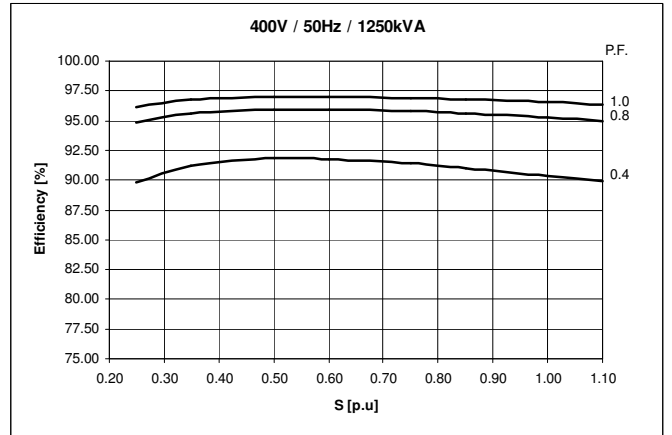
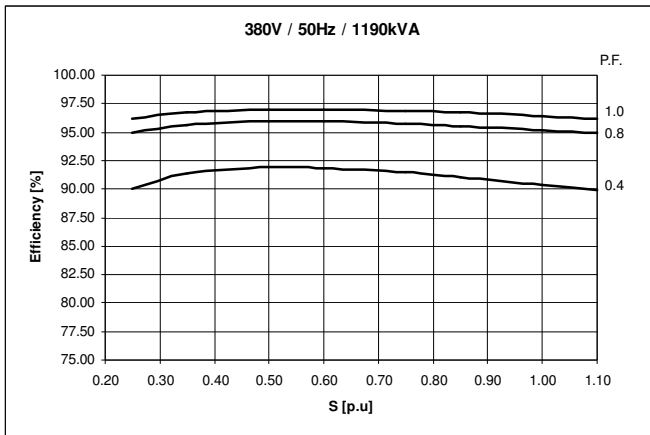
en

Rev. ind.

B

Sheet

4

THREE PHASE EFFICIENCY CURVES, 60 Hz/415-480 V



ABB Generators Ltd.

Document identification
8AMG 5861260

Lang.	Rev. ind.	Sheet
en	B	5

TRANSIENT VOLTAGE REGULATION CURVES

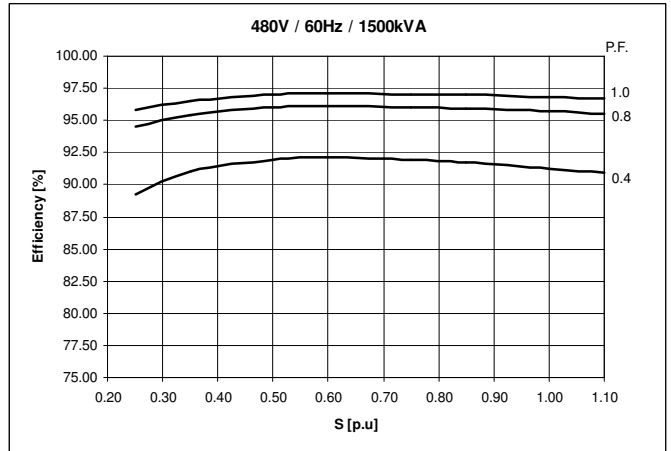
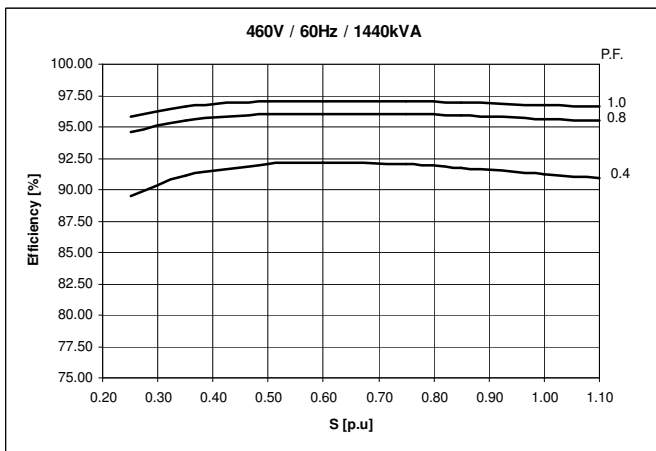
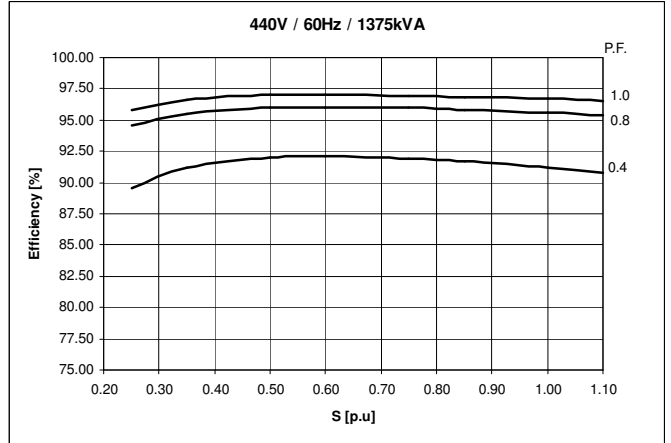
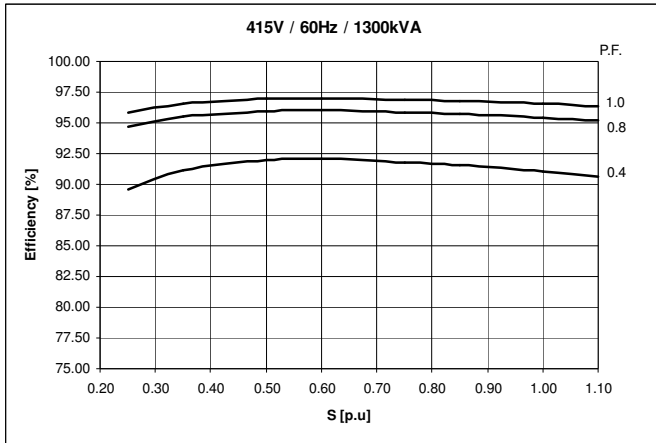
Load application (Auxiliary winding or PMG excitation):

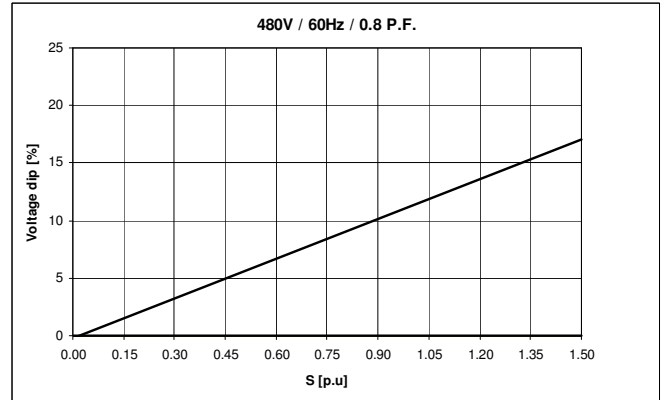
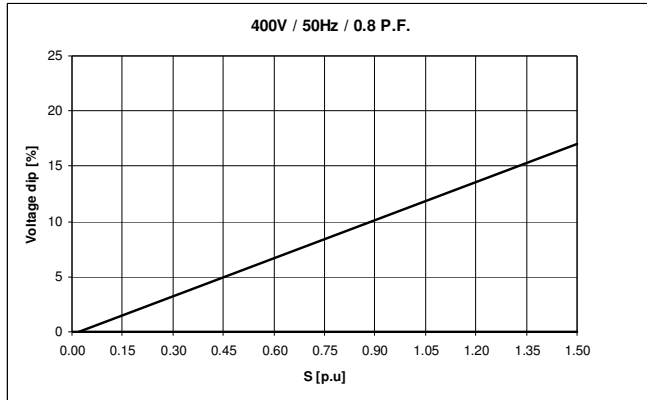

Load rejection (Auxiliary winding or PMG excitation):

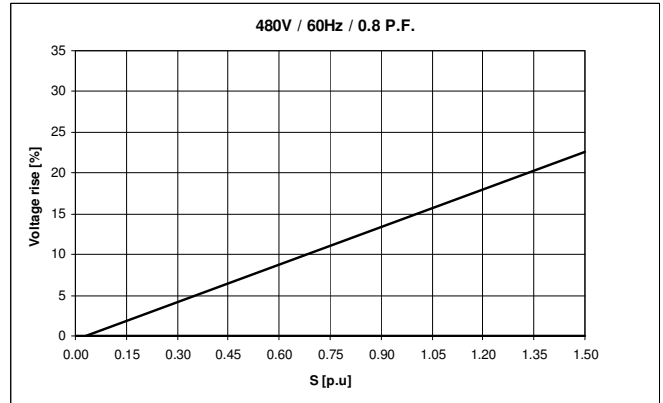
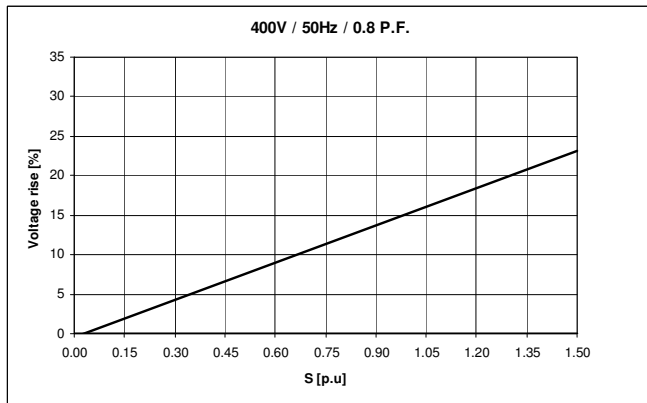

Locked Rotor Motor Starting Curve (Auxiliary winding or PMG excitation):

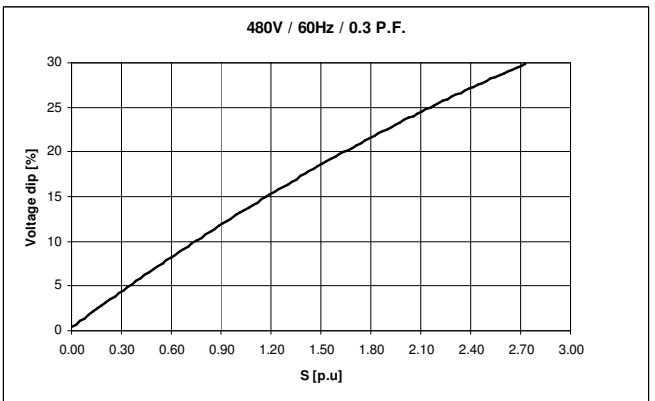
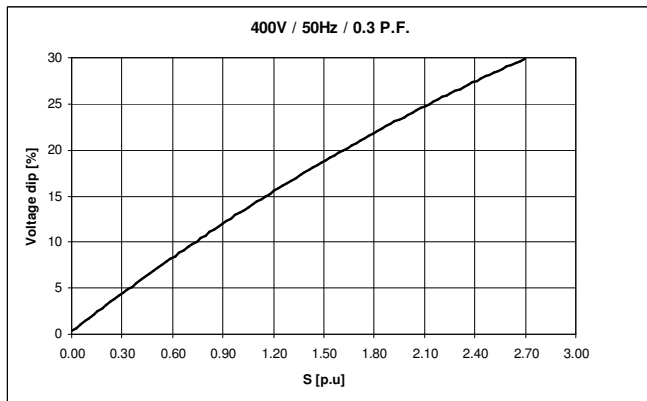

Note1

S [P.U] =S/S(Rated), S stands for the actual operation capacity, S(Rated) stands for the generator rated output capacity.



ABB Generators Ltd.

Document identification

8AMG 5861260

Lang.

en

Rev. ind.

B

Sheet

6

3 CONFIGURATION AND SCOPE OF SUPPLY

GENERAL

The generator is designed to operate together with a diesel or gas engine.

CONSTRUCTION

The stator frame is a rigid welded steel structure construction. The stator core is built of thin electric sheet steel laminations which are insulated on both sides with heat-resistant inorganic resin.

The rotor consists of a shaft and a star shape rotor core. The shaft is machined of rolled steel. Special heat treatment is used if shaft operates under heavy conditions. The poles are manufactured of 0.5 mm sheet steel. The pole laminations are pressed and welded together with steel bars. These bars are then welded to the end plates. Rotor balancing is done acc. to ISO 1940/1. The standard balancing quality grade is G2.5.

All windings are completely vacuum pressure impregnated with high quality resin. The windings are provided with very strong bracing which withstands all expected mechanical and electrical shocks and vibrations as well as chemicals.

End shields are made of casted steel, The stator frame and stator core are welded together, and bolted with end shields.

MAIN TERMINAL SPACE

Protection class IP44, Integrated into the top module of the generator.

Supply cable entries: Closed terminal box. Cable inlet to the main terminal box to be done by the customer.

Six (6) terminals: U1, V1, W1 and U2, V2, W2 brought to the main terminal box. Neutral point (N) made inside the terminal box by separate copper bar connecting U2, V2, W2 together. Main terminals U, V, W and neutral point N in the main terminal box for external connection.

Terminal marking acc. to IEC.

Max. internal air temperature 60 °C.

Designed for continuous current load.

FOUNDATION

The machine can be mounted using shimming, machined blocks, chock fast or on grouted sole plates or bed plate. Before using other mountings, contact us.

CONTROL SYSTEMS

General

Brushless excitation.

Automatic Voltage Regulator System

Mounted inside the main terminal box.

Analog type AVR.

Functions:

- a) 1-channel AVR.
- b) Excitation power from auxiliary winding or PMG.
- c) Voltage set-point adjustment (local).
- d) U/f limiter.
- e) Paralleling operation.



ABB Generators Ltd.

Document identification

8AMG 5861260

Lang.

en

Rev. ind.

B

Sheet

7

Static voltage regulation accuracy +/- 1.0 %.

Voltage recovery time after transient < 1.5 s, +/- 3.0 % (acc. to IEC 60034).

Nominal Um, range: < 90 VDC at 110 VAC input, 170 VDC at 220 VAC input.

Nominal Im, range: continuous 5 ADC.

BEARINGS

Non Drive-end: Rolling, sealed for life, free. Drive-end: Rolling, w/grease, locked. (Double bearing)

Life time: $L_{10} \geq 30\,000$ h.

Calculated maximum bearing temperature 95 °C at ambient 40 °C.

TESTING

Testing is according to IEC and ABB internal requirements. The test may be observed by the customer without extra charges. The test procedures are described in the following documents which are available on request:

-Routine tests: MDD 8006327 (for all machines)

-Type tests: MDD 8006328 (Optional, to be agreed separately).

-Special tests: MDD 8006329 (Optional, to be agreed separately).

PERFORMANCE CHARACTERISTICS AND OPERATIONAL LIMITS

Rating for continuous running duty:

Duty type S1.

Rating for short-time duty:

10 % overload at nominal power factor for one hour at twelve hour intervals.

50 % overload at nominal power factor for two minutes at twelve hour intervals.

Overcurrent withstand capability:

3 times nominal current for 10 s.

Generator shall be suitable for supplying circuits which, when supplied by a system of balanced and sinusoidal voltages:

Result in currents not exceeding a harmonic current factor of 0,05 and

Result in a system of currents where neither the negative-sequence component nor the zero-sequence component exceed 5% of the positive-sequence component.

Maximum voltage unbalance is 0.5 %.

Maximum I_2/I_N value for continuous operation is 8 %.

Maximum $(I_2/I_N)^2 \times t$ in seconds for operation under fault conditions is 20.

Maximum continuous voltage variation with rated output is ± 5 %.

Maximum continuous frequency variation with rated output is ± 2 %.

Maximum combined voltage and frequency variation and maximum short-time limits are acc. to IEC 60034-1:2004, Section 7.3.

Electromagnetic Compatibility (EMC)

Radiated and conducted emissions comply with the requirements of CISPR 11, Class B, Group 1, Table B.1. (IEC 60034-1, Annex B).

TOLERANCES

Efficiency η

Machines up to and including 150 kW (or kVA) -15 % of $(1-\eta)$



ABB Generators Ltd.

Document identification

8AMG 5861260

Lang.

en

Rev. ind.

B

Sheet

8

Machines above 150 kW (or kVA)	-10 % of (1- η)
Total losses (applicable to machines with ratings >150 kW or kVA)	+10 % of the total losses
Peak value of short-circuit current under specified conditions	± 30 % of the value in the technical specification
Steady short-circuit current at specified excitation	± 15 % of the value in the technical specification
Moment of inertia	± 10 % of the value in the technical specification

SURFACE TREATMENT

Grade: C2, Standard color

Surface treatment C2 according to the ISO 12944 standard, for standard industrial environment.

	ABB Generators Ltd.	Document identification	Lang.	Rev. ind.	Sheet
		8AMG 5861260	en	B	9

4 ACCESSORIES

OPTIONAL ACCESSORIES

No pc/pcs	Item	Note
2	Anti-condensation heater	
1	Current transformer	For parallel operation with other generators
6	PT100 for stator winding	
1	PTC sensor (triple)	
1	PMG	



ABB Generators Ltd.

Document identification

8AMG 5861260

Lang.

en

Rev. ind.

B

Sheet

10

5 MAIN DIMENSIONS

SINGLE BEARING

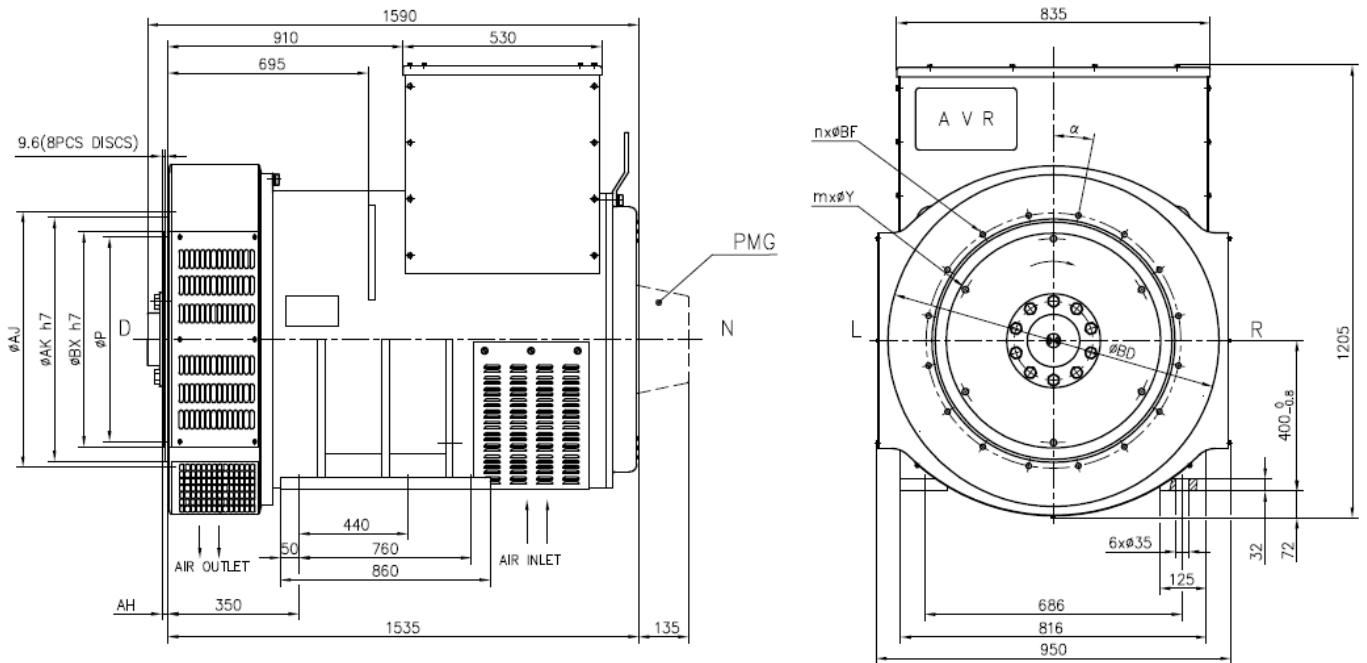

Flange dimensions

S.A.E	AK	AJ	BD	BF	n	a
0	647.7	679.45	883	14	16	11.25°
00	787.4	850.9	883	14	16	11.25°

Flex disc dimensions

S.A.E	BX	P	AH	y	m
18	571.5	542.92	15.7	18	6
21	673.1	641.35	0	18	12



ABB Generators Ltd.

Document identification
8AMG 5861260

Lang.	Rev. ind.	Sheet
en	B	11

DOUBLE BEARINGS

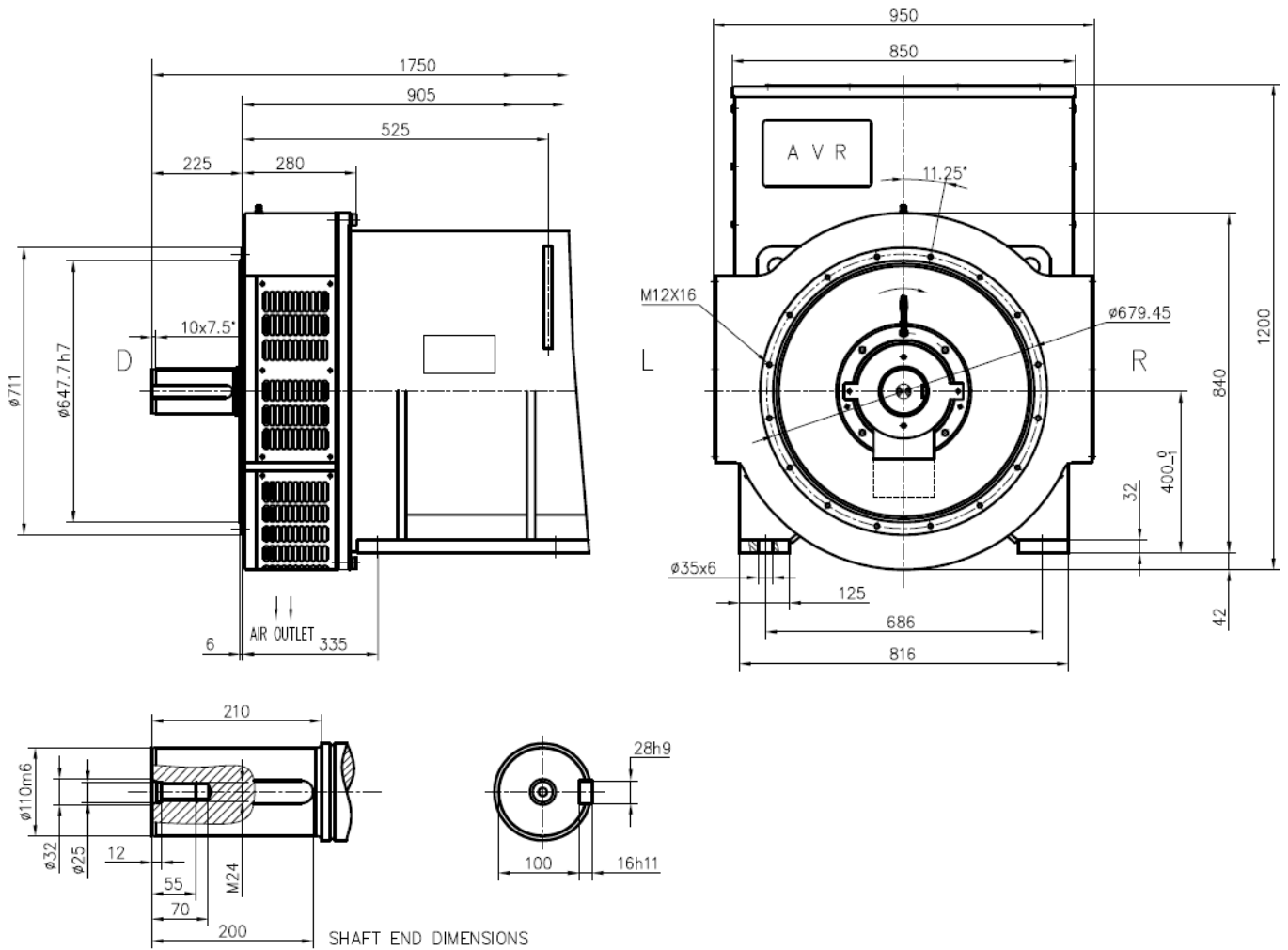

**This is the last page of the document.*

	ABB Generators Ltd.	Document identification	Lang.	Rev. ind.	Sheet
		8AMG 5861260	en	B	12

TEMPLATE: TECHNICALSPECIFICATION.DOT; FILENAME: 5861260-B-AMG 0400ES04 TECHNICAL SPECIFICATION.DOC; PRINTDATE: 9/14/2011 1:14:00 PM; SAVEDATE: 9/7/2011 5:13:00 PM