

Technical specification

Model 9C53200E000001M00

MRP code

Motor parameters

Continuous stall torque	Mo	1	18.4	Nm
Peak stall torque	Mmax	2	55.2	Nm
Rated torque	Mn @ nN	1	14.8	Nm
Rated speed	nN		2000	rpm
Rated frequency	fN		166.7	Hz
Number of motor poles	p		10	

Winding specifications

Torque constant	KTo_cold	2-3-5	2.27	Nm/A
Voltage constant	KE	2-3-4	1.31	Vs/rad
Resistance between phases [Ω]	R	2-3	1.19	Ohm
Inductance between phases [mH]	L	6	18.1	mH
Continuous current @ Mo	Io	1-5	9.2	A
Current @ Mmax	I _{max}	2-5	30.7	A
Rated current @ Mn	I _n	1-5	7.8	A
Bemf between phases @ nN	E _{phph}	2-3-4	275	V

Mechanical parameters

Moment of inertia of rotor	JM	7	31.6	kg.cm ²
Mass of the motor	M	7	20.0	kg
Protection degree (body only)	-		IP65	

Notes:

- 1) Average motor windings over temperature 100 °C, ambient temperature 40 °C, flange mounted (300x300x20 steel)
- 2) All motor parts at 20 °C
- 3) Tolerance +/-10%
- 4) Vrms between phases
- 5) Arms
- 6) Tolerance +/-15%
- 7) Motor without brake

All values have been calculated

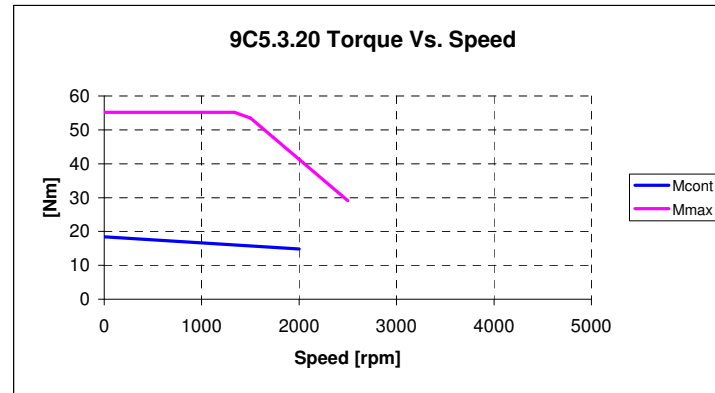

Notes:

DC bus voltage: 565 Vdc (AC 400 V supply)
Max torque curve may depend on actual DC bus voltage.

Transducer type

Endat EQN 1325, 1Vpp, 512 ppr
Sin/Cos Nr.: 512
Interface: EnDat
Rev. Count Bits: 12
Pos. Count Bits: 13

Motor overall dimensions on next page

See motor quick guide for additional information on installation, connections and transducers.

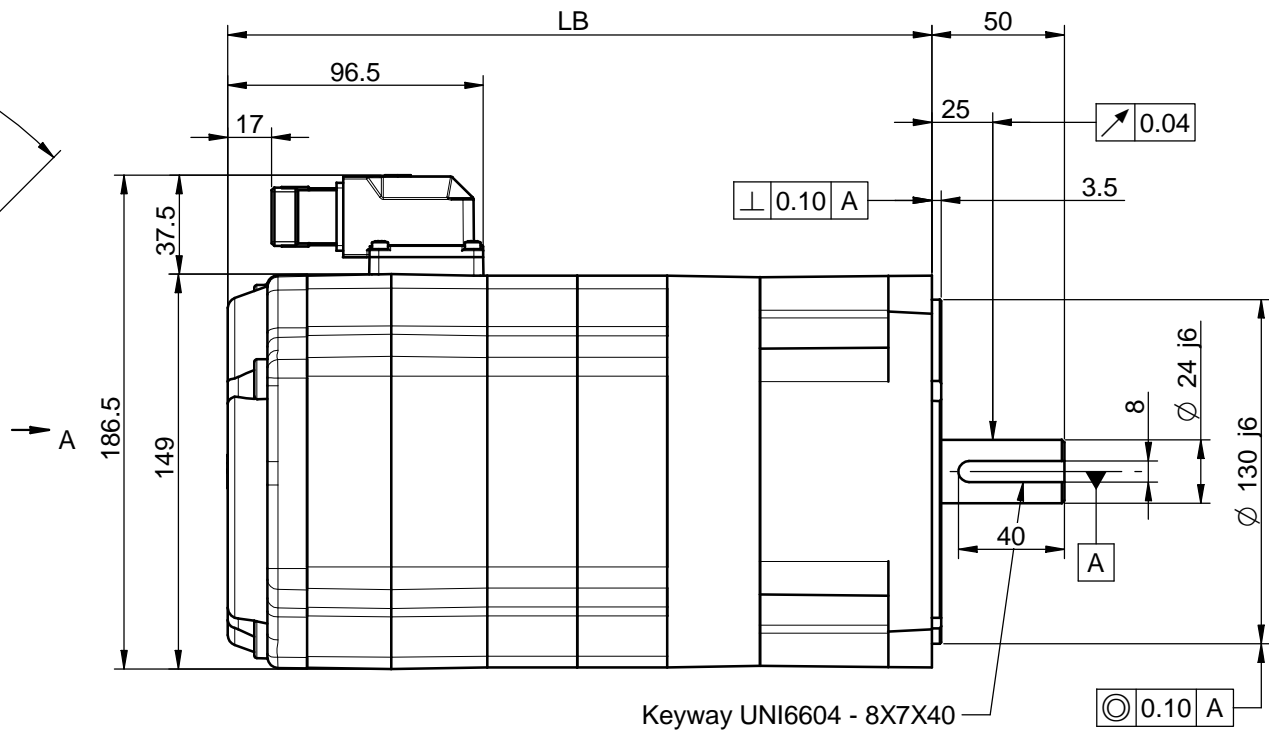
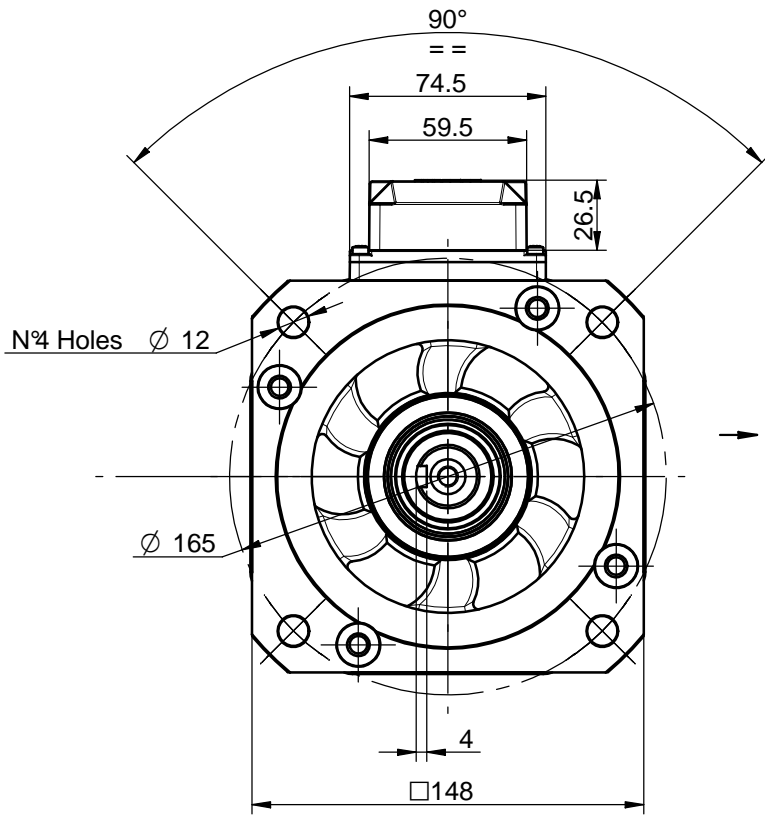

Keyway UNI6604 - 8X7X40

Signal Connector (17 pins) Power Connector (8 pins)

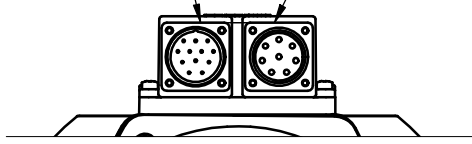

View A

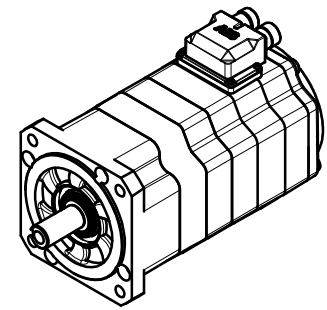

NOTES:

- 1) This drawing refers to 9C5.2 motor equipped with brake and encoder.
- 2) Dimensions may be subject to changes.
- 3) All motors balanced with half-key, full key in package.

Motor Size	LB [mm]
9C5.2	266
9C5.3	300
9C5.4	334
9C5.6	402

(A) - 24/09/08 - Modified dimensions in table, updated drawing
 (B) - 12/11/08 - Removed 32X58 shaft option

<input checked="" type="checkbox"/>	<input checked="" type="checkbox"/>	<input checked="" type="checkbox"/>	<input checked="" type="checkbox"/>	<input checked="" type="checkbox"/>	<input checked="" type="checkbox"/>
C	D	E	F	G	H
I	L	MODIFICHE			

 ABB S.p.A.	QUOTE SENZA INDICAZIONE DI TOLLERANZA GRADO DI PRECISIONE SECONDO UNI 5307-63	<input type="checkbox"/> GROSSOLANO <input type="checkbox"/> MEDIO <input type="checkbox"/> PRECISO	 SCALA 1:2	DATA 22/10/2007
	DENOMINAZIONE 9C5 Motor Overall Dimensions		LAVORAZIONI 0.2 ✓ = ✓ 0.8 ✓ = ✓ 3.2 ✓ = ✓ 12.5 ✓ = ✓ ✓ = ~	DISEGN. PGS
CODICE			SERIE	9C5
MATERIALE	PROTEZ. SUPERFICIALE	PESO	DISEGNO NR.	15.27050

ABB S.p.A., proprietaria di questo disegno, ne vieta la comunicazione a terzi e la diffusione non autorizzata