

High Voltage Surge Arresters Buyer's Guide — Section EXLIM T

Zinc Oxide Surge Arrester EXLIM T

Protection of switchgear, transformers and other equipment in high voltage systems against atmospheric and switching overvoltages.

- in areas with very high lightning intensity
- where grounding or shielding conditions are poor or incomplete
- for important installations
- where energy requirements are very high (e.g. very long lines, capacitor protection).

i Other data can be ordered on request. Please contact your local sales representative.



Brief performance data

System voltages (U_m)	245 - 800 kV
Rated voltages (U_r)	180 - 624 kV
Nominal discharge current (IEC)	20 kA _{peak}
Classifying current (ANSI/IEEE)	10/15/20 kA _{peak}
Discharge current withstand strength:	
High current 4/10 μ s	150 kA _{peak}
Low current 2000 μ s	2200 A _{peak}
Energy capability:	
Line discharge class (IEC)	Class 5
[2 impulses, (IEC Cl. 8.5.5)]	15.4 kJ/kV (U_r)
Fulfills/exceeds requirements of ANSI transmission-line discharge test for 800 kV systems.	
Short-circuit/Pressure relief capability	65 kA _{sym}
External insulation	Fulfills/exceeds standards
Mechanical strength:	
Specified long-term load (SLL)	7200 Nm
Specified short-term load (SSL)	18000 Nm
Service conditions:	
Ambient temperature	-50 °C to +45 °C
Design altitude	max. 1000 m
Frequency	15 - 62 Hz

EXLIM T

Guaranteed protective data

Max. system voltage	Rated voltage	Max. continuous operating voltage ¹⁾		TOV capability ²⁾		Max. residual voltage with current wave						
		as per IEC	as per ANSI/IEEE	1 s	10 s	30/60 μs			8/20 μs			
						U _c	MCOV	1 kA	2 kA	3 kA	5 kA	10 kA
U _m	U _r	U _c	MCOV	1 s	10 s	1 kA	2 kA	3 kA	5 kA	10 kA	20 kA	40 kA
kV _{rms}	kV _{rms}	kV _{rms}	kV _{rms}	kV _{rms}	kV _{rms}	kV _{peak}	kV _{peak}	kV _{peak}	kV _{peak}	kV _{peak}	kV _{peak}	kV _{peak}
245	180	144	144	205	194	346	356	363	381	396	428	466
	192	154	154	218	207	369	380	387	406	423	457	497
	198	156	160	225	213	381	392	399	419	436	471	512
	210	156	170	239	226	404	415	423	444	462	499	543
	216	156	174	246	233	415	427	435	457	476	514	559
	219	156	177	249	236	421	433	441	463	482	521	567
	228	156	180	259	246	438	451	459	482	502	542	590
300	216	173	174	246	233	415	427	435	457	476	514	559
	228	182	182	259	246	438	451	459	482	502	542	590
	240	191	191	273	259	461	475	484	507	528	571	621
	258	191	209	294	278	496	510	520	545	568	614	667
	264	191	212	300	285	508	522	532	558	581	628	683
362	258	206	209	294	278	496	510	520	545	568	614	667
	264	211	212	300	285	508	522	532	558	581	628	683
	276	221	221	314	298	531	546	556	583	608	656	714
	288	230	230	328	311	554	569	580	609	634	685	745
420	330	264	267	376	356	634	652	665	697	726	785	854
	336	267	272	383	362	646	664	677	710	740	799	869
	360	267	291	410	388	692	712	725	761	792	856	931
	372	267	301	424	401	715	735	749	786	819	884	962
	378	267	306	430	408	726	747	761	799	832	899	978
	381	267	308	434	411	732	753	767	805	839	906	985
	390	267	315	444	421	750	771	786	824	858	927	1013
	396	267	318	451	427	761	783	798	837	872	941	1029
	420	267	336	478	453	807	830	846	888	924	998	1091
550	396	317	318	451	427	761	783	798	837	872	941	1029
	420	336	336	478	453	807	830	846	888	924	998	1091
	444	349	353	506	479	853	878	894	938	977	1060	1153
800	588	470	470	670	635	1134	1167	1189	1247	1299	1402	1525
	612	490	490	697	660	1180	1214	1237	1298	1351	1459	1587
	624	499	499	711	673	1203	1238	1261	1323	1378	1488	1618

More detailed information on the TOV capability and the protective characteristics are given in Publ. 1HSM 9543 13-01en.

1) The continuous operating voltages U_c (as per IEC) and MCOV (as per ANSI) differ only due to deviations in type test procedures.

U_c has to be considered only when the actual system voltage is higher than the tabulated.

Any arrester with U_c higher than or equal to the actual system voltage divided by $\sqrt{3}$ can be selected.

2) With prior duty equal to the maximum single-impulse energy stress (10.0 kJ/kV (U_r)).

Arresters with lower or higher rated voltages may be available on request for special applications.

EXLIM T

Technical data for housings

Max. system voltage U_m kV_{rms}	Rated voltage U_r kV_{rms}	Housing	Creepage distance mm	External insulation *)				Dimensions					
				1.2/50 μs dry kV_{peak}	50 Hz wet (60s) kV_{rms}	60 Hz wet (10s) kV_{rms}	250/2500 μs wet kV_{peak}	Mass kg	A_{max} mm	B mm	C mm	D mm	Fig.
245	180-192	BH245	6570	1172	556	546	924	270	2585	800	-	500	2
	198-228	BH245	6570	1172	556	546	924	275	2585	600	-	300	2
	180-198	BV245	7717	1360	656	632	1078	300	2915	800	-	500	2
	210-228	BV245	7717	1360	656	632	1078	305	2915	600	-	300	2
300	228-264	BM300	6570	1172	556	546	924	295	2585	800	-	500	2
	216-264	BH300	7717	1360	656	632	1078	315	2915	800	-	500	2
	216-240	BV300	9855	1758	834	819	1386	395	3860	1600	1000	1000	4
	258-264	BV300	9855	1758	834	819	1386	400	3860	1200	1000	800	4
362	258	BM362	7717	1360	656	632	1078	330	2915	1400	1000	700	3
	264-288	BM362	7717	1360	656	632	1078	335	2915	1200	1000	600	3
	258-288	BH362	9855	1758	834	819	1386	410	3859	1600	1000	1000	4
	258-288	BV362	12149	2134	1034	991	1694	470	4520	1600	1000	1200	4
420	330-360	BM420	8864	1548	756	718	1232	385	3245	1200	1000	600	3
	330-336	BH420	11002	1946	934	905	1540	460	4190	1600	-	1000	4
	360	BH420	11002	1946	934	905	1540	465	4190	1400	1000	700	4
	372-420	BH420	11002	1946	934	905	1540	475	4190	1200	-	600	4
	330-372	BV420	13296	2322	1134	1077	1848	515	4850	1600	-	1000	4
	378-396	BV420	13296	2322	1134	1077	1848	530	4850	1400	1000	700	4
	420	BV420	13296	2322	1134	1077	1848	540	4850	1200	-	600	4
	396-444	BM550	11002	1946	934	905	1540	490	4500	1800	1000	800	5
396-444	BH550	14287	2352	1212	1178	2002	595	5763	2000	1000	1200	6	
800	On request												

Neutral-ground arresters

245	108	BN245	3285	586	278	273	462	140	1315	-	-	-	1
	120-132	BN245	3285	586	278	273	462	145	1315	-	-	-	1
	144	BN245	4432	774	378	359	616	180	1645	-	-	-	1

*) Sum of withstand voltages for empty units of arrester.

EXLIM T

Technical data for housings

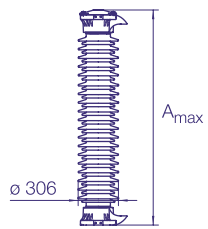

Figure 1

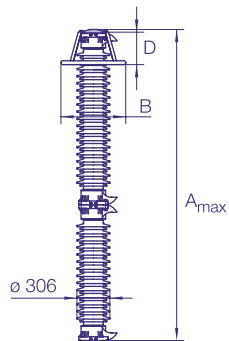

Figure 2

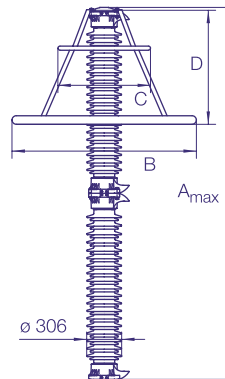

Figure 3

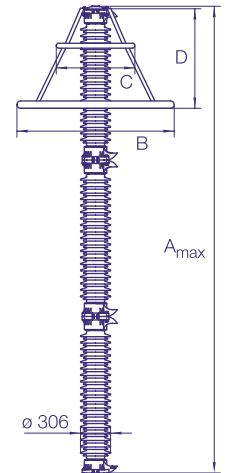

Figure 4

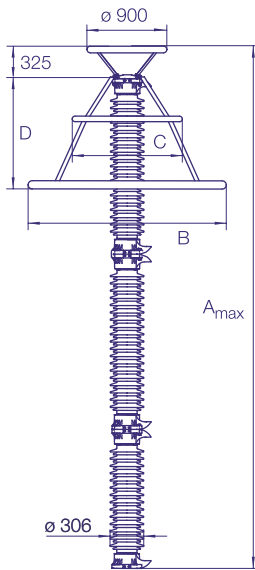

Figure 5

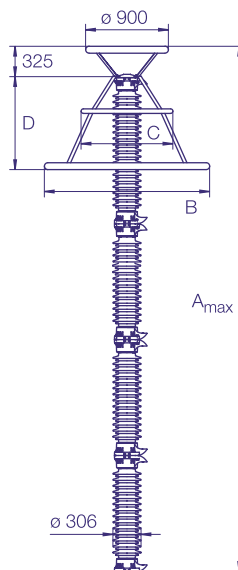
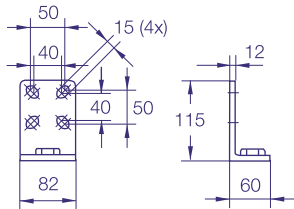

Figure 6

EXLIM T

Accessories

Line terminals



1HSA410 000-A
Aluminium

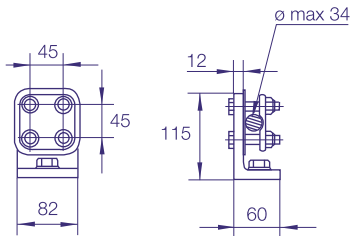

1HSA410 000-B
Aluminium flag with other
items in stainless steel

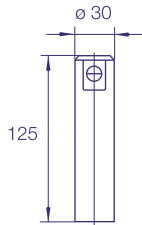

1HSA410 000-C
Aluminium

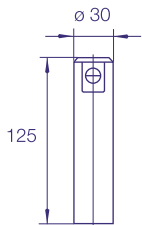

1HSA410 000-D
Stainless steel

Earth terminals

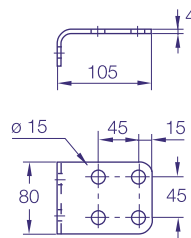

1HSA420 000-C
Stainless steel

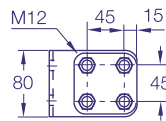
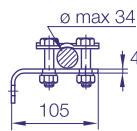

1HSA420 000-D
Stainless steel

Drilling plans

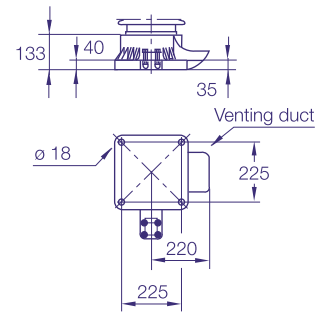

Without insulating base
Aluminium

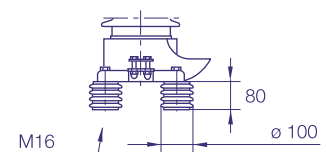
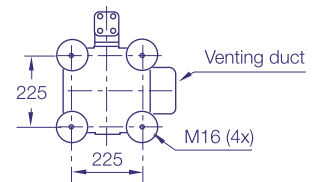

Insulating base
1HSA430 000-C
Epoxy resin

M16 bolts for connection to structure are not supplied by ABB. Required threaded grip length is 15-20 mm.

EXLIM T

Shipping data

Rated voltage U_r kV_{rms}	Housing	Number of arresters per crate					
		One Volume	Gross	Two Volume	Gross	Three Volume	Gross
		m^3	kg	m^3	kg	m^3	kg
180-228	BH245	1.4	320	2.8	635	2.8	925
180-228	BV245	1.7	360	3.1	705	3.1	1025
228-264	BM300	1.4	340	2.8	675	2.8	985
216	BH300	2.2	410	3.8	755	3.8	1080
228-264	BH300	1.7	375	3.1	730	3.1	1060
216-240	BV300	2.9	540	5.7	1010	6.1	1435
258-264	BV300	1.9	490	3.5	965	5.0	1375
258	BM362	2.4	435	4.2	800	4.2	1140
264-288	BM362	2.2	430	3.8	800	3.8	1145
258-288	BH362	2.9	555	5.7	1040	6.1	1480
258-288	BV362	3.2	620	6.3	1150	6.3	1500
330-360	BM420	2.2	485	4.1	900	3.4	1300
330-336	BH420	3.2	605	6.3	1130	6.3	1620
360	BH420	2.4	570	4.2	1100	4.2	1570
372-420	BH420	2.2	575	3.8	1120	3.8	1610
330-336	BV420	3.2	665	6.6	1255	7.0	1805
360-378	BV420	3.2	680	6.6	1280	7.0	1840
381-396	BV420	2.4	640	6.1	1240	6.1	1780
420	BV420	2.2	635	5.8	1225	5.9	1795
396-420	BM550	5.1	710	6.5	1270	6.5	1795
444	BM550	3.2	665	6.0	1215	6.0	1745
396-444	BH550	5.1	805	7.9	1500	7.9	2105

Neutral-ground arresters

108-132	BN245	0.5	180	1.4	345	1.4	500
144	BN245	0.5	220	1.7	415	1.7	605

Each crate contains a certain number of arrester units and accessories for assembly and erection. A packing list is attached externally on each crate.

Each separate crate is numbered and the numbers of all crates and their contents are listed in the shipping specifica-

tion. ABB reserves the right to pack arresters in the most effective/economic combination. Alternate or non-standard crates may involve additional charges.



The table above is to be seen as an approximation and specific data for deliveries may differ from the values given.

For more information please contact:

ABB AB
High Voltage Products
Surge Arresters

SE-771 80 Ludvika, Sweden

Phone: +46 (0)240 78 20 00

Fax: +46 (0)240 179 83

E-Mail: arresters.div@se.abb.com

www.abb.com/arrestersonline

©Copyright 2012 ABB

All rights reserved

NOTE: ABB AB works continuously with product improvements. We therefore reserve the right to change designs, dimensions and data without prior notice.