

High Voltage Surge Arresters Buyer's Guide — Section EXLIM Q-D

Zinc Oxide Surge Arrester EXLIM Q-D

Protection of switchgear, transformers and other equipment in high voltage systems against atmospheric and switching overvoltages.

- in areas with high lightning intensity and high energy requirements.
- where grounding or shielding conditions are poor or incomplete.



Other data can be ordered on request. Please contact your local sales representative.



Brief performance data

System voltages (U_m) 170 - 420 kV

Rated voltages (U_r) 132 - 420 kV

Nominal discharge current (IEC) 10 kA_{peak}

Classifying current (ANSI/IEEE) 10 kA_{peak}

Discharge current withstand strength:

High current 4/10 μ s 100 kA_{peak}

Low current 2000 μ s 1000 A_{peak}

Energy capability:

Line discharge class (IEC) Class 3
[2 impulses, (IEC Cl. 8.5.5) 7.8 kJ/kV (U_r)]

Fulfills/exceeds requirements of ANSI transmission-line discharge test for 245 kV systems.

Short-circuit/Pressure relief capability 65 kA_{sym}

External insulation Fulfills/exceeds standards

Mechanical strength:

Specified long-term load (SLL) 7200 Nm

Specified short-term load (SSL) 18000 Nm

Service conditions:

Ambient temperature -50 °C to +45 °C

Design altitude max. 1000 m

Frequency 15 - 62 Hz

EXLIM Q-D

Guaranteed protective data

Max. system voltage	Rated voltage	Max. continuous operating voltage ¹⁾		TOV capability ²⁾		Max. residual voltage with current wave						
		as per IEC	as per ANSI/IEEE	1 s	10 s	30/60 μ s			8/20 μ s			
						U _c	MCOV	0.5 kA	1 kA	2 kA	5 kA	10 kA
U _m	U _r	U _c	MCOV	1 s	10 s	0.5 kA	1 kA	2 kA	5 kA	10 kA	20 kA	40 kA
kV _{rms}	kV _{rms}	kV _{rms}	kV _{rms}	kV _{rms}	kV _{rms}	kV _{peak}	kV _{peak}	kV _{peak}	kV _{peak}	kV _{peak}	kV _{peak}	kV _{peak}
170	132	106	106	153	145	254	262	272	295	311	342	382
	144	108	115	167	158	277	286	297	322	339	373	417
	162	108	131	187	178	312	321	334	362	381	419	469
	168	108	131	194	184	323	333	346	376	395	435	486
245	180	144	144	208	198	346	357	371	402	423	466	521
	192	154	154	222	211	369	381	396	429	452	497	555
	198	156	160	229	217	381	393	408	443	466	512	573
	210	156	170	243	231	404	417	433	469	494	543	608
	216	156	175	250	237	415	428	445	483	508	559	625
	219	156	177	254	240	421	434	451	489	515	567	634
	228	156	180	264	250	438	452	470	510	536	590	660
300	216	173	175	250	237	415	428	445	483	508	559	625
	228	182	182	264	250	438	452	470	510	536	590	660
	240	191	191	278	264	461	476	495	536	564	621	694
	258	191	209	299	283	496	512	532	576	607	667	746
	264	191	212	306	290	507	523	544	590	621	683	764
362	258	206	209	299	283	496	512	532	576	607	667	746
	264	211	212	306	290	507	523	544	590	621	683	764
	276	211	221	320	303	530	547	569	617	649	714	798
	288	230	230	334	316	553	571	593	643	677	745	833
420	330	264	267	382	363	634	654	680	737	776	854	954
	336	267	272	389	369	646	666	692	751	790	869	972
	360	267	291	417	396	692	714	742	804	846	931	1046
	372	267	301	431	409	715	737	766	831	875	962	1080
	378	267	306	438	415	726	749	779	844	889	978	1098
	381	267	308	441	419	732	755	785	851	896	985	1106
	390	267	315	452	429	749	773	803	871	917	1013	1132
	396	267	318	459	435	761	785	816	885	931	1029	1150
	420	267	335	487	462	807	833	865	938	987	1091	1219

More detailed information on the TOV capability and the protective characteristics are given in Publ. 1HSM 9543 13-01en.

1) The continuous operating voltages U_c (as per IEC) and MCOV (as per ANSI) differ only due to deviations in type test procedures.
U_c has to be considered only when the actual system voltage is higher than the tabulated.
Any arrester with U_c higher than or equal to the actual system voltage divided by $\sqrt{3}$ can be selected.

2) With prior duty equal to the maximum single-impulse energy stress (4.5 kJ/kV (U_r)).

Arresters with lower or higher rated voltages may be available on request for special applications.

EXLIM Q-D

Technical data for housings

Max. system voltage	Rated voltage	Housing	Creepage distance	External insulation *)				Dimensions					
				1.2/50 μ s dry	50 Hz wet (60s)	60 Hz wet (10s)	250/2500 μ s wet	Mass	A _{max}	B	C	D	Fig.
U _m	U _r												
kV _{rms}	kV _{rms}		mm	kV _{peak}	kV _{rms}	kV _{rms}	kV _{peak}	kg	mm	mm	mm	mm	
170	132	DH170	4432	774	378	359	n.a.	155	1645	600	-	300	2
	144-168	DH170	4432	774	378	359	n.a.	155	1645	-	-	-	1
	132-144	DV170	6570	1172	556	546	924	230	2585	800	-	500	3
	162-168	DV170	6570	1172	556	546	924	230	2585	600	-	300	3
245	180-219	DH245	6570	1172	556	546	924	230	2585	800	-	500	3
	228	DH245	6570	1172	556	546	924	235	2585	600	-	300	3
	180	DV245	7717	1360	656	632	1078	270	2915	1400	1000	700	4
	192-198	DV245	7717	1360	656	632	1078	270	2915	1200	1000	600	4
	210-228	DV245	7717	1360	656	632	1078	270	2915	800	-	500	3
300	228-264	DM300	6570	1172	556	546	924	240	2585	800	-	500	3
	216	DH300	7717	1360	656	632	1078	275	2915	1400	1000	700	4
	228-240	DH300	7717	1360	656	632	1078	280	2915	1200	1000	600	4
	258-264	DH300	7717	1360	656	632	1078	275	2915	800	-	500	3
	216	DV300	9855	1758	834	819	1386	350	3859	1600	1000	1200	6
	228-240	DV300	9855	1758	834	819	1386	355	3859	1600	1000	1000	6
	258-264	DV300	9855	1758	834	819	1386	355	3859	1200	1000	800	6
362	258-264	DM362	7717	1360	656	632	1078	280	2915	1400	1000	700	5
	276-288	DM362	7717	1360	656	632	1078	285	2915	1200	1000	600	5
	258-288	DH362	9855	1758	834	819	1386	360	3859	1600	1000	1000	6
	258-288	DV362	12149	2134	1034	991	1694	415	4520	1800	1000	1000	6
420	330-360	DM420	8864	1548	756	718	1232	325	3245	1400	1000	700	5
	330-360	DH420	11002	1946	934	905	1540	400	4190	1800	1000	1000	6
	372-396	DH420	11002	1946	934	905	1540	400	4190	1400	1000	700	6
	420	DH420	11002	1946	934	905	1540	400	4190	1200	1000	600	6
	330-420	DV420	13296	2322	1134	1077	1848	465	4850	1800	1000	1000	6

*) Sum of withstand voltages for empty units of arrester.

EXLIM Q-D

Technical data for housings

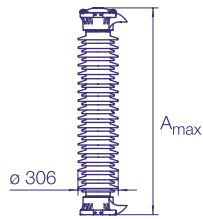

Figure 1

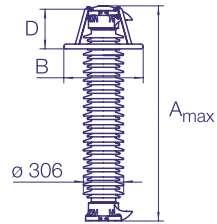

Figure 2

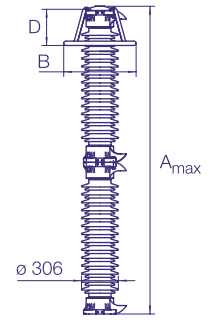

Figure 3

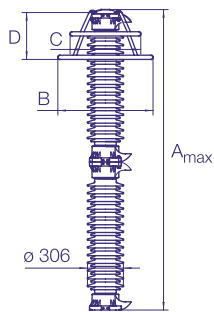

Figure 4

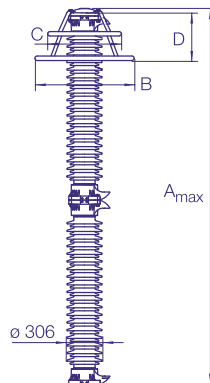

Figure 5

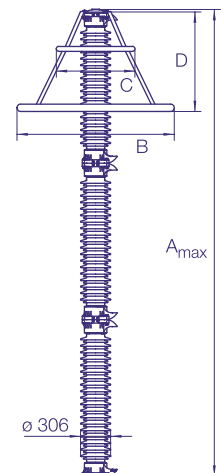
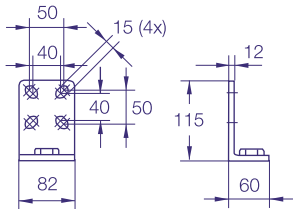

Figure 6

EXLIM Q-D

Accessories

Line terminals



1HSA410 000-A
Aluminium

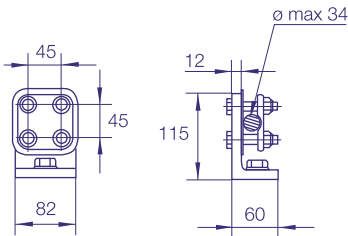

1HSA410 000-B
Aluminium flag with other
items in stainless steel

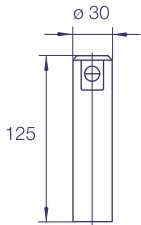

1HSA410 000-C
Aluminium

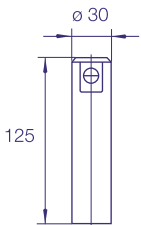

1HSA410 000-D
Stainless steel

Earth terminals

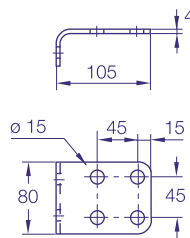

1HSA420 000-C
Stainless steel

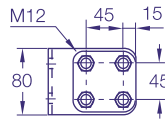
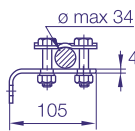

1HSA420 000-D
Stainless steel

Drilling plans

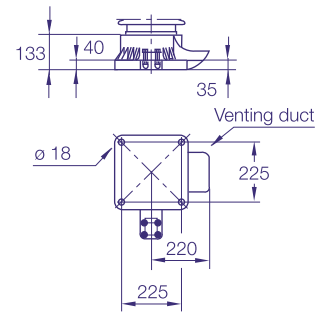

Without insulating base
Aluminium

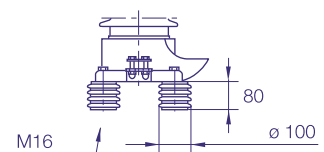
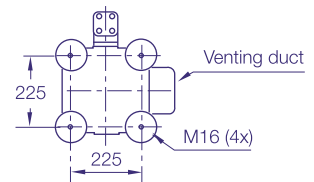

Insulating base
1HSA430 000-C
Epoxy resin

M16 bolts for connection to structure are not supplied by ABB. Required threaded grip length is 15-20 mm.

EXLIM Q-D

Shipping data

Rated voltage U_r kV_{rms}	Housing	Number of arresters per crate					
		One Volume	Gross	Three Volume	Gross	Six Volume	Gross
		m^3	kg	m^3	kg	m^3	kg
132-168	DH170	0.5	195	1.7	365	1.7	530
132-168	DV170	1.4	275	2.8	545	2.8	790
180-228	DH245	1.4	280	2.8	555	2.8	805
180	DV245	2.4	375	4.2	685	4.1	960
192-198	DV245	2.2	360	3.8	670	3.9	950
210-228	DV245	1.7	315	3.1	615	3.1	890
228-264	DM300	1.4	290	2.8	575	2.8	835
216	DH300	2.4	380	4.2	695	4.1	975
228-240	DH300	2.2	365	3.8	680	3.9	965
258-264	DH300	1.7	320	3.1	630	3.1	910
216-240	DV300	2.9	500	5.7	930	6.1	1315
258-264	DV300	1.9	445	3.6	875	5.0	1240
258-264	DM362	2.4	385	4.2	705	4.1	995
276-288	DM362	2.2	375	3.8	690	3.9	985
258-288	DH362	2.9	505	5.7	940	6.1	1330
258-264	DV362	3.2	575	6.3	1075	6.7	1535
276-288	DV362	3.2	575	6.0	1060	6.7	1525
330-360	DM420	4.2	475	4.9	835	5.3	1175
330-360	DH420	3.2	545	6.0	1015	6.7	1430
372-396	DH420	2.4	505	5.6	970	5.5	1380
420	DH420	2.2	485	5.2	945	5.3	1370
330-360	DV420	3.2	615	6.6	1150	7.0	1450

Each crate contains a certain number of arrester units and accessories for assembly and erection. A packing list is attached externally on each crate.

Each separate crate is numbered and the numbers of all crates and their contents are listed in the shipping specifica-

tion. ABB reserves the right to pack arresters in the most effective/economic combination. Alternate or non-standard crates may involve additional charges.



The table above is to be seen as an approximation and specific data for deliveries may differ from the values given.

For more information please contact:

ABB AB
High Voltage Products
Surge Arresters

SE-771 80 Ludvika, Sweden

Phone: +46 (0)240 78 20 00

Fax: +46 (0)240 179 83

E-Mail: arresters.div@se.abb.com

www.abb.com/arrestersonline

©Copyright 2012 ABB

All rights reserved

NOTE: ABB AB works continuously with product improvements. We therefore reserve the right to change designs, dimensions and data without prior notice.