

High Voltage Surge Arresters Buyer's Guide — Section EXLIM Q-E

Zinc Oxide Surge Arrester EXLIM Q-E

Protection of switchgear, transformers and other equipment in high voltage systems against atmospheric and switching overvoltages.

- in areas with high lightning intensity and high energy requirements.
- where grounding or shielding conditions are poor or incomplete.

 Other data can be ordered on request. Please contact your local sales representative.



Brief performance data

System voltages (U_m)	52 - 245 kV
Rated voltages (U_r)	42 - 228 kV
Nominal discharge current (IEC)	10 kA _{peak}
Classifying current (ANSI/IEEE)	10 kA _{peak}
Discharge current withstand strength:	
High current 4/10 μ s	100 kA _{peak}
Low current 2000 μ s	1 000 A _{peak}
Energy capability:	
Line discharge class (IEC)	Class 3
[2 impulses, (IEC Cl. 8.5.5)]	7.8 kJ/kV (U_r)
Fulfils/exceeds requirements of ANSI transmission-line discharge test for 245 kV systems.	
Short-circuit/Pressure relief capability	65 kA _{sym}
External insulation	Fulfils/exceeds standards
Mechanical strength:	
Specified long-term load (SLL)	3000 Nm
Specified short-term load (SSL)	7500 Nm
Service conditions:	
Ambient temperature	-50 °C to +45 °C
Design altitude	max. 1 000 m
Frequency	15 - 62 Hz

EXLIM Q-E

Guaranteed protective data 36 - 145 kV

Max. system voltage	Rated voltage	Max. continuous operating voltage ¹⁾		TOV capability ²⁾		Max. residual voltage with current wave						
		as per IEC	as per ANSI/IEEE	1 s	10 s	30/60 μs			8/20 μs			
						U _c	MCOV	0.5 kA	1 kA	2 kA	5 kA	10 kA
U _m	U _r	U _c	MCOV	1 s	10 s	0.5 kA	1 kA	2 kA	5 kA	10 kA	20 kA	40 kA
kV _{rms}	kV _{rms}	kV _{rms}	kV _{rms}	kV _{rms}	kV _{rms}	kV _{peak}	kV _{peak}	kV _{peak}	kV _{peak}	kV _{peak}	kV _{peak}	kV _{peak}
36³⁾	24	19.2	19.5	27.8	26.4	46.1	47.6	49.5	53.6	56.4	62.1	69.4
	30	24.0	24.4	34.8	33.0	57.6	59.5	61.8	67.0	70.5	77.6	86.8
	33	26.4	26.7	38.2	36.3	63.4	65.4	68.0	73.7	77.6	85.4	95.4
	36	28.8	29.0	41.7	39.6	69.2	71.4	74.2	80.4	84.6	93.1	105
	39	31.2	31.5	45.2	42.9	74.9	77.3	80.3	87.1	91.7	101	113
52	42	34	34.0	48.7	46.2	80.7	83.3	86.5	93.8	98.7	109	122
	48	38	39.0	55.6	52.8	92.2	95.1	98.9	108	113	125	139
	51	41	41.3	59.1	56.1	98.0	102	105	114	120	132	148
	54	43	43.0	62.6	59.4	104	107	112	121	127	140	157
	60	48	48.0	69.6	66.0	116	119	124	134	141	156	174
72	54	43	43.0	62.6	59.4	104	107	112	121	127	140	157
	60	48	48.0	69.6	66.0	116	119	124	134	141	156	174
	66	53	53.4	76.5	72.6	127	131	136	148	156	171	191
	72	58	58.0	83.5	79.2	139	143	149	161	170	187	209
	75	60	60.7	87.0	82.5	144	149	155	168	177	194	217
	78	62	63.1	90.4	85.8	150	155	161	175	184	202	226
	81	65	65.6	93.9	89.1	156	161	167	181	191	210	235
100	84	67	68.0	97.4	92.4	162	167	173	188	198	218	243
	90	72	72.0	104	99.0	173	179	186	201	212	233	261
	96	77	77.0	111	105	185	191	198	215	226	249	278
	123	90	72	72.0	104	99.0	173	179	186	201	212	233
123	96	77	77.0	111	105	185	191	198	215	226	249	278
	108	78	84.0	125	118	208	214	223	242	254	280	313
	120	78	98.0	139	132	231	238	248	268	282	311	347
	132	78	106	153	145	254	262	272	295	311	342	382
	138	78	111	160	151	265	274	285	309	325	357	399
	145	108	86	86.0	125	118	208	214	223	242	254	280
120		92	98.0	139	132	231	238	248	268	282	311	347
132		92	106	153	145	254	262	272	295	311	342	382
138		92	111	160	151	265	274	285	309	325	357	399
144		92	115	167	158	277	286	297	322	339	373	417

More detailed information on the TOV capability and the protective characteristics are given in Publ. 1HSM 9543 13-01en.

1) The continuous operating voltages U_c (as per IEC) and MCOV (as per ANSI) differ only due to deviations in type test procedures.

U_c has to be considered only when the actual system voltage is higher than the tabulated.

Any arrester with U_c higher than or equal to the actual system voltage divided by $\sqrt{3}$ can be selected.

2) With prior duty equal to the maximum single-impulse energy stress (4.5 kJ/kV (U_r)).

3) Arresters for system voltages 36 kV or below can be supplied, on request, when the order also includes arresters for higher system voltages.

Arresters with lower or higher rated voltages may be available on request for special applications.

EXLIM Q-E

Guaranteed protective data 170 - 245 kV

Max. system voltage	Rated voltage	Max. continuous operating voltage ¹⁾		TOV capability ²⁾		Max. residual voltage with current wave						
		as per IEC	as per ANSI/IEEE	1 s	10 s	30/60 μs			8/20 μs			
		U _c	MCOV			0.5 kA	1 kA	2 kA	5 kA	10 kA	20 kA	40 kA
U _m	U _r	U _c	MCOV	1 s	10 s	0.5 kA	1 kA	2 kA	5 kA	10 kA	20 kA	40 kA
kV _{rms}	kV _{rms}	kV _{rms}	kV _{rms}	kV _{rms}	kV _{rms}	kV _{peak}	kV _{peak}	kV _{peak}	kV _{peak}	kV _{peak}	kV _{peak}	kV _{peak}
170	132	106	106	153	145	254	262	272	295	311	342	382
	144	108	115	167	158	277	286	297	322	339	373	417
	162	108	131	187	178	312	321	334	362	381	419	469
	168	108	131	194	184	323	333	346	376	395	435	486
245	180	144	144	208	198	346	357	371	402	423	466	521
	192	154	154	222	211	369	381	396	429	452	497	555
	198	156	160	229	217	381	393	408	443	466	512	573
	210	156	170	243	231	404	417	433	469	494	543	608
	216	156	175	250	237	415	428	445	483	508	559	625
	219	156	177	254	240	421	434	451	489	515	567	634
	222	156	179	257	244	427	440	458	496	522	574	642
	228	156	180	264	250	438	452	470	510	536	590	660

More detailed information on the TOV capability and the protective characteristics are given in Publ. 1HSM 9543 13-01en.

1) The continuous operating voltages U_c (as per IEC) and MCOV (as per ANSI) differ only due to deviations in type test procedures. U_c has to be considered only when the actual system voltage is higher than the tabulated. Any arrester with U_c higher than or equal to the actual system voltage divided by $\sqrt{3}$ can be selected.

2) With prior duty equal to the maximum single-impulse energy stress (4.5 kJ/kV (U_i)).

Arresters with lower or higher rated voltages may be available on request for special applications.

EXLIM Q-E

Technical data for housings

Max. system voltage U_m kV_{rms}	Rated voltage U_r kV_{rms}	Housing	Creepage distance mm	External insulation *)				Dimensions					
				1.2/50 μs dry kV_{peak}	50 Hz wet (60s) kV_{rms}	60 Hz wet (10s) kV_{rms}	250/2500 μs wet kV_{peak}	Mass kg	A_{max} mm	B mm	C mm	D mm	Fig.
36	24-39	EV036	1615	275	129	133	n.a.	45	725	-	-	-	1
52	42-60	EV052	1615	275	129	133	n.a.	48	725	-	-	-	1
72	54-84	EV072	2651	394	221	203	n.a.	66	997	-	-	-	1
100	84-96	EH100	2651	394	221	203	n.a.	67	997	-	-	-	1
	84-96	EV100	3685	568	287	261	n.a.	82	1268	-	-	-	1
123	90-108	EM123	2651	394	221	203	n.a.	69	997	-	-	-	1
	90-138	EH123	3685	568	287	261	n.a.	88	1268	-	-	-	1
	90-96	EV123	4266	669	350	336	n.a.	106	1697	600	-	300	3
	108-138	EV123	4266	669	350	336	n.a.	110	1697	-	-	-	2
145	108-144	EH145	3685	568	287	261	n.a.	88	1268	-	-	-	1
	108-120	EV145	5302	788	442	406	n.a.	124	1969	600	-	300	3
	132-144	EV145	5302	788	442	406	n.a.	125	1969	-	-	-	2
170	132-144	EM170	3685	568	287	261	n.a.	88	1268	-	-	-	1
	132	EH170	4266	669	350	336	n.a.	111	1697	600	-	300	3
	144-168	EH170	4266	669	350	336	n.a.	113	1697	-	-	-	2
	132-144	EV170	5302	788	442	406	n.a.	127	1969	600	-	300	3
	162-168	EV170	5302	788	442	406	n.a.	128	1969	-	-	-	2
245	180-198	EH245	6336	962	508	464	753	151	2240	600	800	400	4
	210-228	EH245	6336	962	508	464	753	153	2240	600	-	300	3
	180-228	EV245	7953	1182	663	609	960	201	2941	800	1400	700	5

Neutral-ground arresters

52	30-36	EN052	1615	275	129	133	n.a.	45	725	-	-	-	1
72	42-54	EN072	1615	275	129	133	n.a.	48	725	-	-	-	1
100	60	EN100	1615	275	129	133	n.a.	48	725	-	-	-	1
123	72-108	EN123	2651	394	221	203	n.a.	69	997	-	-	-	1
	120	EN123	3685	568	287	261	n.a.	88	1268	-	-	-	1
145	84-108	EN145	2651	394	221	203	n.a.	69	997	-	-	-	1
	120	EN145	3685	568	287	261	n.a.	88	1268	-	-	-	1
170	96-108	EN170	2651	394	221	203	n.a.	69	997	-	-	-	1
	120	EN170	3685	568	287	261	n.a.	88	1268	-	-	-	1
245	108	EN245	2651	394	221	203	n.a.	69	997	-	-	-	1
	120-144	EN245	3685	568	287	261	n.a.	88	1268	-	-	-	1

*) Sum of withstand voltages for empty units of arrester.

EXLIM Q-E

Technical data for housings

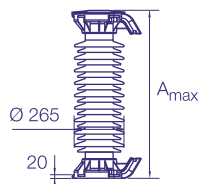

Figure 1

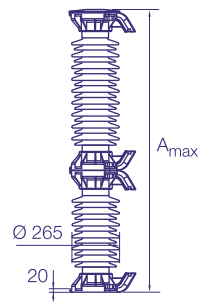

Figure 2

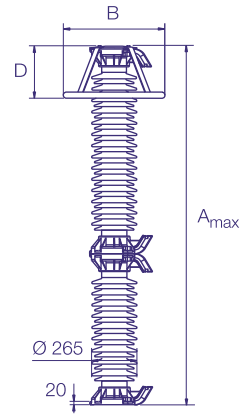

Figure 3

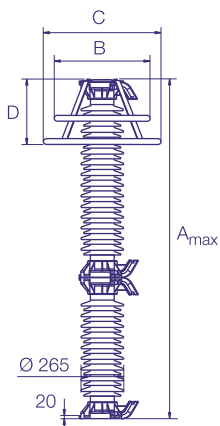

Figure 4

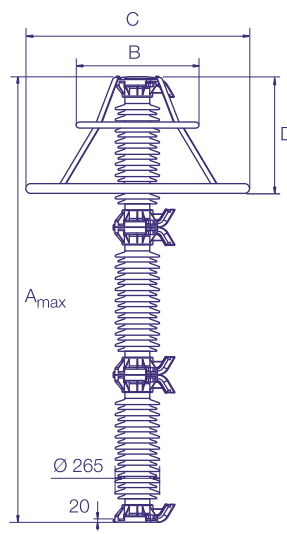
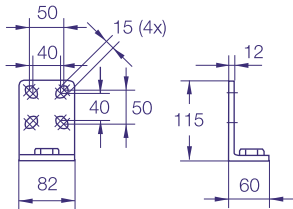

Figure 5

EXLIM Q-E

Accessories

Line terminals



1HSA410 000-A
Aluminium

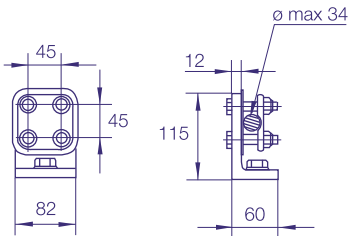

1HSA410 000-B
Aluminium flag with other
items in stainless steel

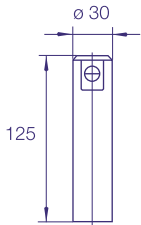

1HSA410 000-C
Aluminium

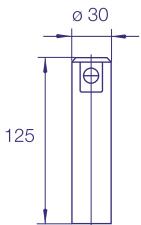

1HSA410 000-D
Stainless steel

Earth terminals

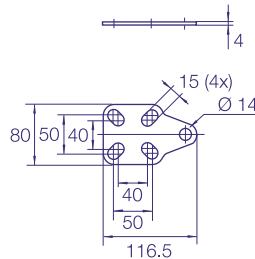

1HSA420 000-A
Stainless steel

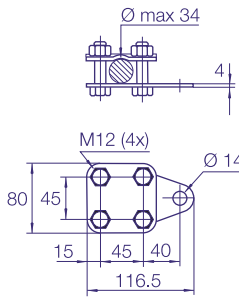

1HSA420 000-B
Stainless steel

Drilling plans

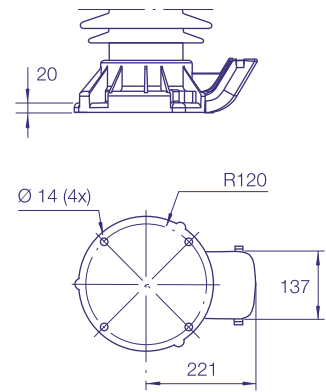

Without insulating base
Aluminium

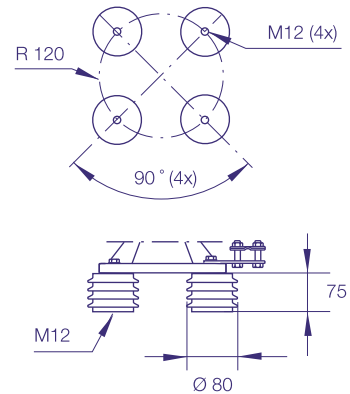

Insulating base
1HSA430 000-A
Epoxy resin

M12 bolts for connection to structure are not supplied by ABB. Required threaded grip length is 15-20 mm.

EXLIM Q-E

Shipping data

Rated voltage U_r kV _{rms}	Housing	Number of arresters per crate					
		One Volume	Gross	Three Volume	Gross	Six Volume	Gross
		m ³	kg	m ³	kg	m ³	kg
24-39	EV036	0.3	76	0.5	177	1.0	349
42-60	EV052	0.3	79	0.5	186	1.0	367
54-84	EV072	0.3	97	0.7	240	1.4	475
84-96	EH100	0.3	98	0.7	243	1.4	481
84-96	EV100	0.4	119	0.8	288	1.7	571
90-108	EM123	0.3	100	0.7	249	1.4	493
90-108	EH123	0.4	125	0.8	306	1.7	607
90-138	EV123	0.7	138	1.4	389	-	-
108-144	EH145	0.4	125	0.9	306	1.7	607
108-144	EV145	0.7	152	1.4	431	-	-
132-144	EM170	0.4	125	0.9	306	1.7	607
132-168	EH170	0.7	141	1.4	398	-	-
132-168	EV170	0.7	156	1.4	662	-	-
180-228	EH245	0.8	181	1.7	518	-	-
180-228	EV245	1.7	320	3.1	743	-	-

Neutral-ground arresters

30-36	EN052	0.3	80	0.5	180	1.0	350
42-54	EN072	0.3	80	0.5	190	1.0	370
60	EN100	0.3	80	0.5	190	1.0	370
72-108	EN123	0.3	100	0.7	250	1.4	495
120	EN123	0.4	125	0.8	310	1.7	610
84-108	EN145	0.3	100	0.7	250	1.4	495
120	EN145	0.4	125	0.8	310	1.7	610
96-108	EN170	0.3	100	0.7	250	1.4	495
120	EN170	0.4	125	0.8	310	1.7	610
108	EN245	0.3	100	0.7	250	1.4	495
120-144	EN245	0.4	125	0.8	310	1.7	610

Each crate contains a certain number of arrester units and accessories for assembly and erection. A packing list is attached externally on each crate.

Each separate crate is numbered and the numbers of all crates and their contents are listed in the shipping specifica-

tion. ABB reserves the right to pack arresters in the most effective/economic combination. Alternate or non-standard crates may involve additional charges.



The table above is to be seen as an approximation and specific data for deliveries may differ from the values given.

For more information please contact:

ABB AB
High Voltage Products
Surge Arresters

SE-771 80 Ludvika, Sweden

Phone: +46 (0)240 78 20 00

Fax: +46 (0)240 179 83

E-Mail: arresters.div@se.abb.com

www.abb.com/arrestersonline

©Copyright 2010 ABB

All rights reserved

NOTE! ABB AB is working continuously to improve the products. We therefore reserve the right to change designs, dimensions and data without prior notice.