

High Voltage Surge Arresters Buyer's Guide — Section PEXLIM Q

Zinc Oxide Surge Arrester PEXLIM Q

Protection of switchgear, transformers and other equipment in high voltage systems against atmospheric and switching overvoltages.

- in areas with high lightning intensity and high energy requirements.
- where grounding or shielding conditions are poor or incomplete.

Superior where low weight, reduced clearances, flexible mounting, non-fragility and additional personnel safety is required.

Major component in PEXLINK™ concept for transmission line protection.

 Other data can be ordered on request. Please contact your local sales representative.



Brief performance data

System voltages (U_m) 52 - 420 kV

Rated voltages (U_r) 42 - 360 kV

Nominal discharge current (IEC) 10 kA_{peak}

Classifying current (ANSI/IEEE) 10 kA_{peak}

Discharge current withstand strength:

High current 4/10 μ s 100 kA_{peak}

Low current 2000 μ s 1000 A_{peak}

Energy capability:

Line discharge class (IEC) Class 3
[2 impulses, (IEC Cl. 8.5.5) 7.8 kJ/kV (U_r)]

Fulfills/exceeds requirements of ANSI transmission-line discharge test for 170 kV systems.

Short-circuit/Pressure relief capability 50 kA_{sym}

External insulation Fulfills/exceeds standards

Mechanical strength:

Specified long-term load (SLL) 2500 Nm

Specified short-term load (SSL) 4000 Nm

Service conditions:

Ambient temperature -50 °C to +45 °C

Design altitude max. 1000 m

Frequency 15 - 62 Hz

PEXLIM Q

Guaranteed protective data 24 - 123 kV

Max. system voltage	Rated voltage	Max. continuous operating voltage ¹⁾		TOV capability ²⁾		Max. residual voltage with current wave						
		as per IEC	as per ANSI/IEEE			30/60 μs			8/20 μs			
				U _c	MCOV	1 s	10 s	0.5 kA	1 kA	2 kA	5 kA	10 kA
U _m	U _r	U _c	MCOV	1 s	10 s	0.5 kA	1 kA	2 kA	5 kA	10 kA	20 kA	40 kA
kV _{rms}	kV _{rms}	kV _{rms}	kV _{rms}	kV _{rms}	kV _{rms}	kV _{peak}	kV _{peak}	kV _{peak}	kV _{peak}	kV _{peak}	kV _{peak}	kV _{peak}
24 ³⁾	24	19.2	19.4	27.6	26.4	46.1	47.6	49.5	53.6	56.4	62.1	69.4
36 ³⁾	30	24.0	24.4	34.5	33.0	57.6	59.5	61.8	67.0	70.5	77.6	86.8
	36	28.8	29.0	41.4	39.6	69.2	71.4	74.2	80.4	84.6	93.1	105
52	42	34	34.0	48.3	46.2	80.7	83.3	86.5	93.8	98.7	109	122
	48	38	39.0	55.2	52.8	92.2	95.1	98.9	108	113	125	139
	51	41	41.3	58.6	56.1	98.0	102	105	114	120	132	148
	54	43	43.0	62.1	59.4	104	107	112	121	127	140	157
	60	48	48.0	69.0	66.0	116	119	124	134	141	156	174
	72	58	58.0	82.8	79.2	139	143	149	161	170	187	209
72	54	43	43.0	62.1	59.4	104	107	112	121	127	140	157
	60	48	48.0	69.0	66.0	116	119	124	134	141	156	174
	66	53	53.4	75.9	72.6	127	131	136	148	156	171	191
	72	58	58.0	82.8	79.2	139	143	149	161	170	187	209
	75	60	60.7	86.2	82.5	144	149	155	168	177	194	217
	78	62	63.1	89.7	85.8	150	155	161	175	184	202	226
	81	65	65.6	93.1	89.1	156	161	167	181	191	210	235
	84	67	68.0	96.6	92.4	162	167	173	188	198	218	243
100	75	59	60.7	86.2	82.5	144	149	155	168	177	194	217
	78	61	63.1	89.7	85.8	150	155	161	175	184	202	226
	84	65	68.0	96.6	92.4	162	167	173	188	198	218	243
	90	69	72.0	103	99.0	173	179	186	201	212	233	261
	96	74	77.0	110	105	185	191	198	215	226	249	278
	123	90	72	72.0	103	99.0	173	179	186	201	212	233
96		77	77.0	110	105	185	191	198	215	226	249	278
102		78	82.6	117	112	196	203	210	228	240	264	295
108		78	84.0	124	118	208	214	223	242	254	280	313
120		78	98.0	138	132	231	238	248	268	282	311	347
129		78	104	148	141	248	256	266	288	304	334	373
132		78	106	151	145	254	262	272	295	311	342	382
138		78	111	158	151	265	274	285	309	325	357	399
144		78	115	165	158	277	286	297	322	339	373	417
150		78	121	172	165	288	298	309	335	353	388	434

More detailed information on the TOV capability and the protective characteristics are given in Publ. 1HSM 9543 13-01en.

1) The continuous operating voltages U_c (as per IEC) and MCOV (as per ANSI) differ only due to deviations in type test procedures.
U_c has to be considered only when the actual system voltage is higher than the tabulated.
Any arrester with U_c higher than or equal to the actual system voltage divided by $\sqrt{3}$ can be selected.

2) With prior duty equal to the maximum single-impulse energy stress (4.5 kJ/kV (U_p)).

3) Arresters for system voltages 36 kV or below can be supplied, on request, when the order also includes arresters for higher system voltages.

Arresters with lower or higher rated voltages may be available on request for special applications.

PEXLIM Q

Guaranteed protective data 145 - 420 kV

Max. system voltage	Rated voltage	Max. continuous operating voltage ¹⁾		TOV capability ²⁾		Max. residual voltage with current wave						
		as per IEC	as per ANSI/IEEE	1 s	10 s	30/60 μ s			8/20 μ s			
						U _c	MCOV	0.5 kA	1 kA	2 kA	5 kA	10 kA
U _m	U _r	U _c	MCOV	1 s	10 s	0.5 kA	1 kA	2 kA	5 kA	10 kA	20 kA	40 kA
kV _{rms}	kV _{rms}	kV _{rms}	kV _{rms}	kV _{rms}	kV _{rms}	kV _{peak}	kV _{peak}	kV _{peak}	kV _{peak}	kV _{peak}	kV _{peak}	kV _{peak}
145	108	86	86.0	124	118	208	214	223	242	254	280	313
	120	92	98.0	138	132	231	238	248	268	282	311	347
	132	92	106	151	145	254	262	272	295	311	342	382
	138	92	111	158	151	265	274	285	309	325	357	399
	144	92	115	165	158	277	286	297	322	339	373	417
	150	92	121	172	165	288	298	309	335	353	388	434
	162	92	131	186	178	312	321	334	362	381	419	469
	168	92	131	193	184	323	333	346	376	395	435	486
170	132	106	106	151	145	254	262	272	295	311	342	382
	144	108	115	165	158	277	286	297	322	339	373	417
	150	108	121	172	165	288	298	309	335	353	388	434
	162	108	131	186	178	312	321	334	362	381	419	469
	168	108	131	193	184	323	333	346	376	395	435	486
	192	108	152	220	211	369	381	396	429	452	497	555
245	180	144	144	207	198	346	357	371	402	423	466	521
	192	154	154	220	211	369	381	396	429	452	497	555
	198	156	160	227	217	381	393	408	443	466	512	573
	210	156	170	241	231	404	417	433	469	494	543	608
	216	156	175	248	237	415	428	445	483	508	559	625
	219	156	177	251	240	421	434	451	489	515	567	634
	222	156	179	255	244	427	440	458	496	522	574	642
	228	156	180	262	250	438	452	470	510	536	590	660
300	216	173	175	248	237	415	428	445	483	508	559	625
	240	191	191	276	264	461	476	495	536	564	621	694
	258	191	209	296	283	496	512	532	576	607	667	746
	264	191	212	303	290	507	523	544	590	621	683	764
	276	191	220	317	303	530	547	569	617	649	714	798
362	258	206	209	296	283	496	512	532	576	607	667	746
	264	211	212	303	290	507	523	544	590	621	683	764
	276	221	221	317	303	530	547	569	617	649	714	798
	288	230	230	331	316	553	571	593	643	677	745	833
420	330	264	267	379	363	634	654	680	737	776	854	954
	336	267	272	386	369	646	666	692	751	790	869	972
	342	267	277	393	376	657	678	705	764	804	885	989
	360	267	291	414	396	692	714	742	804	846	931	1046

More detailed information on the TOV capability and the protective characteristics are given in Publ. 1HSM 9543 13-01en.

1) The continuous operating voltages U_c (as per IEC) and MCOV (as per ANSI) differ only due to deviations in type test procedures. U_c has to be considered only when the actual system voltage is higher than the tabulated. Any arrester with U_c higher than or equal to the actual system voltage divided by $\sqrt{3}$ can be selected.

2) With prior duty equal to the maximum single-impulse energy stress (4.5 kJ/kV (U_n)).

Arresters with lower or higher rated voltages may be available on request for special applications.

PEXLIM Q

Technical data for housings

Max. system voltage	Rated voltage	Housing	Creepage distance	External insulation *)				Dimensions						
				1.2/50 μ s dry	50 Hz wet (60s)	60 Hz wet (10s)	250/2500 μ s wet	Mass	A _{max}	B	C	D	Fig.	
U _m	U _r							kg	mm	mm	mm	mm	mm	
kV _{rms}	kV _{rms}		mm	kV _{peak}	kV _{rms}	kV _{rms}	kV _{peak}							
24	24	XV024	1363	283	126	126	242	21	481	-	-	-	-	1
36	30-36	XV036	1363	283	126	126	242	21	481	-	-	-	-	1
52	42-72	XV052	2270	400	187	187	330	25	736	-	-	-	-	1
72	54-72	XV072	2270	400	187	187	330	25	736	-	-	-	-	1
	75-84	XV072	3625	578	293	293	462	38	1080	-	-	-	-	1
100	75-96	XV100	3625	578	293	293	462	38	1080	-	-	-	-	1
123	90-120	XH123	3625	578	293	293	462	37	1080	-	-	-	-	1
	90-144	XV123	4540	800	374	374	660	45	1397	-	-	-	-	2
	150	XV123	4988	861	419	419	704	52	1486	-	-	-	-	2
145	108-120	XH145	3625	578	293	293	462	36	1080	-	-	-	-	1
	108-144	XV145	4540	800	374	374	660	45	1397	-	-	-	-	2
	150	XV145	4988	861	419	419	704	52	1486	-	-	-	-	2
	162-168	XV145	5895	978	480	480	792	56	1741	-	-	-	-	2
170	132-144	XH170	4540	800	374	374	660	48	1400	400	-	-	160	3
	150	XH170	4988	861	419	419	704	54	1489	400	-	-	160	3
	132-192	XV170	5895	978	480	480	792	59	1744	400	-	-	160	3
245	192	XM245	5895	978	480	480	492	59	1761	600	-	-	300	4
	180-228	XH245	7250	1156	586	586	924	73	2105	600	-	-	300	4
	180-198	XV245	8613	1439	712	712	1166	94	2617	800	-	-	500	5
	210-228	XV245	8613	1439	712	712	1166	91	2617	600	-	-	300	5
300	216-276	XH300	8613	1439	712	712	1166	94	2617	800	-	-	500	5
	216-276	XV300	9520	1556	773	773	1254	98	2872	800	-	-	500	5
362	258-288	XH362	9520	1556	773	773	1254	103	2872	1200	1000	-	600	6
	258-288	XV362	11790	1956	960	960	1584	127	3491	1400	1000	-	700	7
420	330-360	XH420	10875	1734	879	879	1386	116	3216	1400	1000	-	700	6

*) Sum of withstand voltages for empty units of arrester.

PEXLIM Q

Technical data for housings

Max. system voltage	Rated voltage	Housing	Creepage distance	External insulation *)				Dimensions					
				1.2/50 μ s dry	50 Hz wet (60s)	60 Hz wet (10s)	250/2500 μ s wet	Mass	A _{max}	B	C	D	Fig.
U _m	U _r			kV _{peak}	kV _{rms}	kV _{rms}	kV _{peak}	kg	mm	mm	mm	mm	
kV _{rms}	kV _{rms}		mm										

Neutral-ground arresters

52	30-36	XN052	1363	400	187	187	330	21	736	-	-	-	1
72	42-54	XN072	2270	400	187	187	330	24	736	-	-	-	1
100	60	XN100	2270	400	187	187	330	25	736	-	-	-	1
123	72	XN123	2270	400	187	187	330	25	736	-	-	-	1
	75-120	XN123	3625	578	293	293	462	38	1080	-	-	-	1
145	84-120	XN145	3625	578	293	293	462	37	1080	-	-	-	1
170	84-120	XN170	3625	578	293	293	462	37	1080	-	-	-	1
245	108-120	XN245	3625	578	293	293	462	36	1080	-	-	-	1
	132-144	XN245	4540	800	374	374	660	45	1397	-	-	-	2

*) Sum of withstand voltages for empty units of arrester.

PEXLIM Q

Technical data for housings

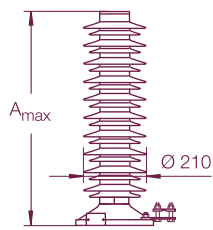

Figure 1

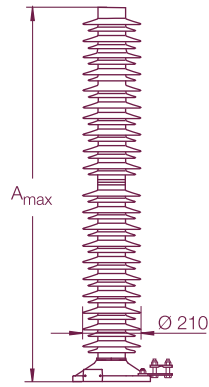

Figure 2

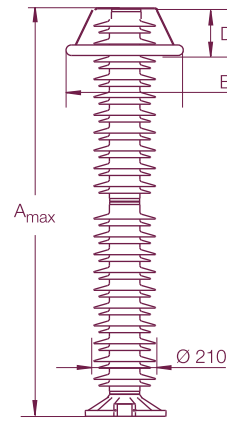

Figure 3

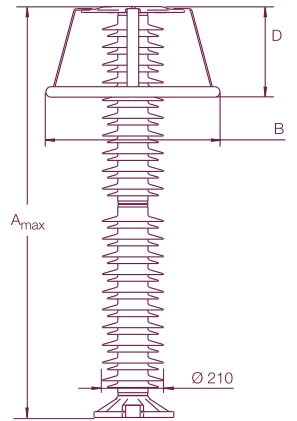

Figure 4

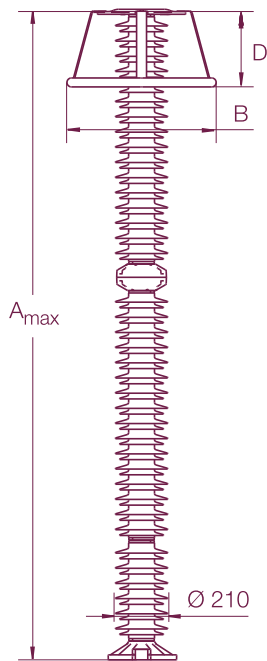

Figure 5

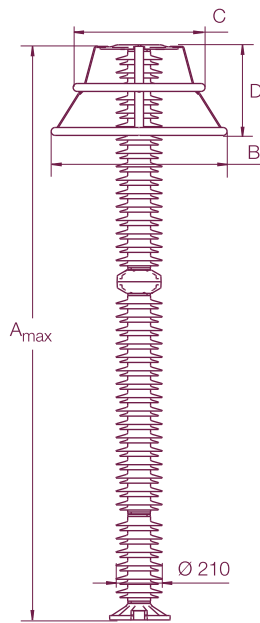

Figure 6

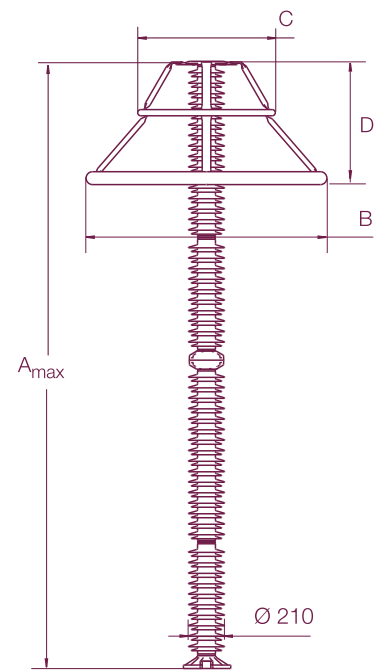
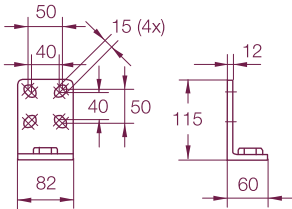

Figure 7

PEXLIM Q

Accessories

Line terminals



1HSA410 000-L
Aluminium

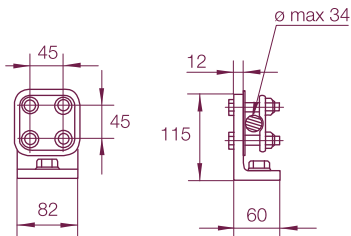

1HSA410 000-M
Aluminium flag with other
items in stainless steel

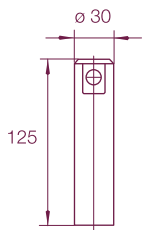

1HSA410 000-N
Aluminium

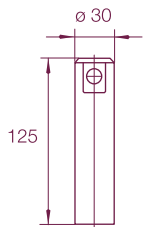

1HSA410 000-P
Stainless steel

Earth terminals

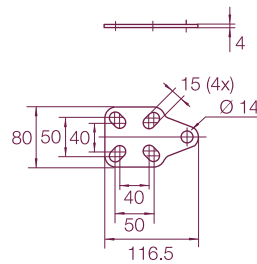

1HSA420 000-A
Stainless steel

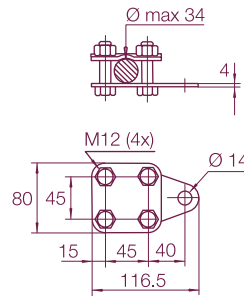

1HSA420 000-B
Stainless steel

Drilling plans

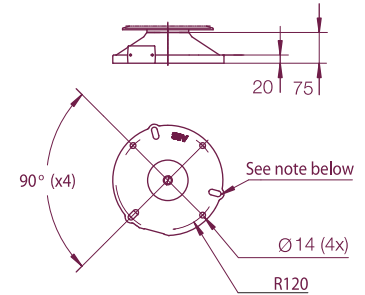

NOTE! Alternative drilling plan
3 slotted holes (120 °), n14 at R111-127

Without insulating base
Aluminium

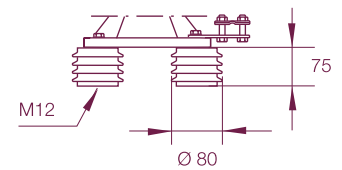
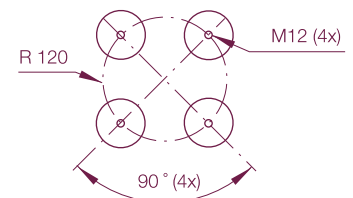

Insulating base
1HSA430 000-A
Epoxy resin

M12 bolts for connection to structure
are not supplied by ABB. Required
threaded grip length is 15-20 mm.

PEXLIM Q

Shipping data

Rated voltage U_r kV_{rms}	Housing	Number of arresters per crate					
		One Volume m^3	Gross kg	Three Volume m^3	Gross kg	Six Volume m^3	Gross kg
24	XV024						
30-36	XV036						
042-072	XV052	0.5	49	0.5	107	0.9	194
054-072	XV072	0.5	49	0.5	107	0.9	194
075-084	XV072	0.7	65	0.7	145	1.2	265
075-096	XV100	0.7	65	0.7	145	1.2	265
090-120	XH123	0.7	65	0.7	145	1.2	265
090-096	XV123	0.9	81	0.9	183	1.5	336
108-144	XV123	0.9	81	0.9	183	1.5	336
150	XV123	0.9	81	0.9	183	1.5	336
108-120	XH145	0.7	67	0.7	151	1.2	277
108-120	XV145	0.9	82	0.9	186	1.5	338
132-144	XV145	0.9	81	0.9	186	1.5	342
150	XV145	0.9	82	0.9	186	1.5	342
162-168	XV145	1.1	95	1.1	215	1.9	395
132-144	XH170	0.9	84	0.9	192	1.5	354
150	XH170	0.9	84	0.9	192	1.5	354
132	XV170	1.1	98	1.1	224	1.9	413
144-192	XV170	1.1	98	1.1	224	1.9	413
192	XM245	1.1	100	1.1	230	1.9	425
180-210	XH245	1.1	111	1.1	263	1.9	491
216-228	XH245	1.1	109	1.1	257	1.9	479
180-198	XV245	1.0	164	1.7	340	-	-
210-228	XV245	0.9	115	1.5	291	-	-
216-276	XH300	0.9	126	1.7	345	-	-
216	XV300	1.5	211	2.6	443	-	-
240-258	XV300	1.4	192	2.3	416	-	-
264-276	XV300	1.0	157	1.7	369	-	-
258-264	XH362	1.5	211	2.5	443	-	-
276-288	XH362	1.4	192	2.3	416	-	-
258-288	XV362	2.2	278	3.8	564	-	-
330-360	XH420	2.2	268	3.8	534	-	-

Each crate contains a certain number of arrester units and accessories for assembly and erection. A packing list is attached externally on each crate.

Each separate crate is numbered and the numbers of all crates and their contents are listed in the shipping specifica-

tion. ABB reserves the right to pack arresters in the most effective/economic combination. Alternate or non-standard crates may involve additional charges.



The table above is to be seen as an approximation and specific data for deliveries may differ from the values given.

PEXLIM Q

Shipping data

Rated voltage U_r kV_{rms}	Housing	Number of arresters per crate					
		One		Three		Six	
		Volume	Gross	Volume	Gross	Volume	Gross
		m^3	kg	m^3	kg	m^3	kg

Neutral-ground arresters

30-36	XN052	0.5	49	0.5	83	0.9	146
42-54	XN072	0.5	49	0.5	83	0.9	146
60	XN100	0.5	49	0.5	83	0.9	146
72	XN123	0.5	49	0.5	83	0.9	146
75-120	XN123	0.7	65	0.7	145	1.2	265
84-120	XN145	0.7	65	0.7	145	1.2	265
84-120	XN170	0.7	65	0.7	145	1.2	265
108-120	XN245	0.7	65	0.7	145	1.2	265
132, 144	XN245	0.9	81	0.9	183	1.5	336

Each crate contains a certain number of arrester units and accessories for assembly and erection. A packing list is attached externally on each crate.

Each separate crate is numbered and the numbers of all crates and their contents are listed in the shipping specifica-

tion. ABB reserves the right to pack arresters in the most effective/economic combination. Alternate or non-standard crates may involve additional charges.



The table above is to be seen as an approximation and specific data for deliveries may differ from the values given.

For more information please contact:

ABB AB
High Voltage Products
Surge Arresters

SE-771 80 Ludvika, Sweden

Phone: +46 (0)240 78 20 00

Fax: +46 (0)240 179 83

E-Mail: arresters.div@se.abb.com

www.abb.com/arrestersonline

©Copyright 2012 ABB

All rights reserved

NOTE: ABB AB works continuously with product improvements. We therefore reserve the right to change designs, dimensions and data without prior notice.