

Water Inlet or Outlet R1/2

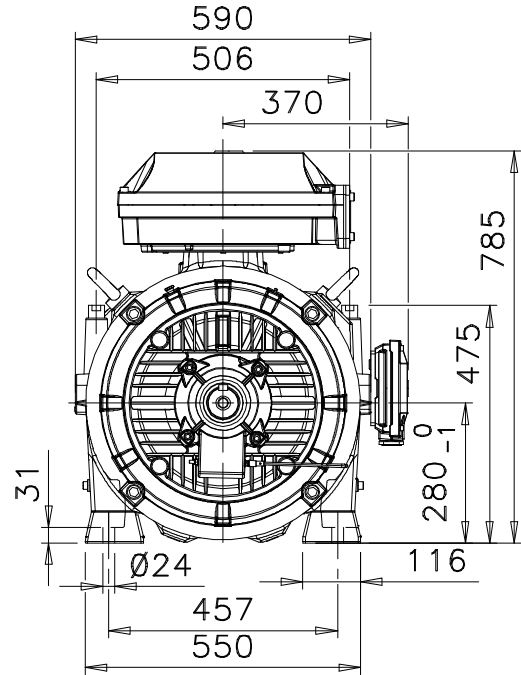
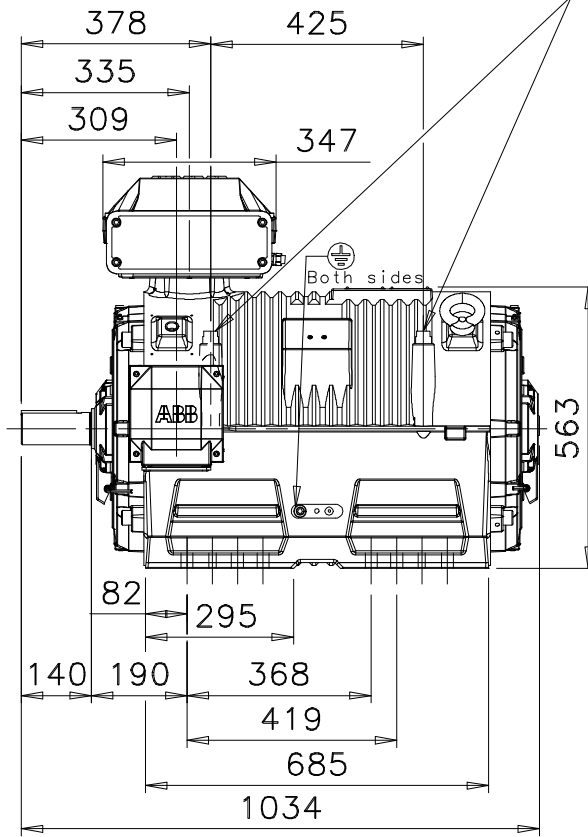
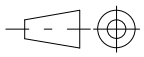

Additional information:

<p>Dimension Print</p>	<p>Motor Type: M3LP 280SM_2 B3, B6, B7, B8, V5, V6</p>	<p>Document No: 3GZF500628-55 A 14 LP 280 A</p>
<p>Description: WATER COOLED SQUIRREL CAGE MOTOR WITH TERMINAL BOX 370 AND AUXILIARY TERMINAL BOX (CAST IRON).</p>		
<p>Unit: Motors Date: 21.05.2010</p>	<p>Issued by: J.Mustonen Approved by: P.Viitanen</p>	<p>Replaces: Replaced by:</p>
<p>ABB Oy</p>	<p>Customer Reference:</p>	