

Reliability analysis

Data and modeling software is helping an NGL plant determine maintenance approaches and improve equipment reliability

Fernando Vicente, Hector Kessel, Richard M. Rockwood

Over the past several years, reliability – ie, the probability that a product, equipment or process will perform its intended function, without failure, under specific conditions for a specific period of time – has become an increasingly important topic when it comes to continuous improvement. Higher plant reliability reduces process- and equipment-failure costs, and contributes to increased production – and thus a greater gross margin. In addition, it increases workplace safety and reduces potentially serious environmental risks.

Today, in the intensively competitive oil & gas industry, gas plants must operate at a high level of reliability without wasting money or incurring extra costs. ABB is helping such companies to achieve this goal by using objective, quantifiable measures to address equipment failures at earlier stages of failure development. This article presents three specific examples of reliability analysis performed at MEGA's Loma La Lata site in Argentina. And the results – savings!

Enlightened organizations strive for zero defects and zero accidents. Many of those same organizations also apply the “zero tolerance” rule to equipment failures and have a goal of zero failures. However, equipment that is left unattended will eventually fail. To address this, leading organizations are implementing two important equipment management strategies: condition-based maintenance, and reliability practices. The key factor is to obtain control of failures by anticipating them early on and intervening with planned and scheduled approaches.

Reliability practices are making great contributions in this two-pronged strategy, as is shown in the following three case studies. The first examines the reliability analysis of a natural gas liquids (NGL) pump’s mechanical seal; the second looks at the validation of a modification in a screw compressor; and the third addresses the reliability analysis of a temperature transmitter (TT).

MEGA – ABB Full Service® partnership

As part of its ABB Full Service® contract with MEGA (a gas plant located at the Loma La Lata site in Neuquen, Argentina), ABB is responsible for mechanical, electrical, instrumentation, and static management, as well

1 MEGA gas plant operations at the Loma La Lata site in Argentina

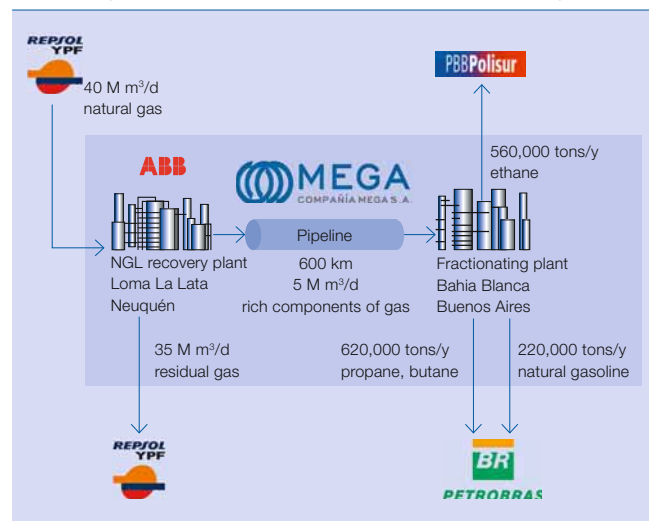

into a pipeline that supplies the domestic market. The other components are piped to another facility located in Bahía Blanca for further processing. This facility is a fractionating plant that separates the NGL into ethane, propane, butane, and gasoline, which are then sold to their customers – namely, the Argentine government and the Bahía Blanca facility 1.

Meeting customer expectations

Equipment availability is approaching world-class levels 2. However, this indicator reflects the availability of process-critical equipment, much

as static inspection, planning, scheduling, and complete material management of spare parts.

To truly compete in a global environment, an organization needs not only high equipment availability, but also high equipment reliability – selecting the best approach is key.

The MEGA facility is responsible for the recovery and separation of NGL. This process involves separating the methane from other NGL components and then injecting the methane back

of it with offline spares or online backup equipment. As a Full Service provider, ABB is expected to deliver the latest in service technology and leading-edge management practices. Thus ABB was asked to start focusing on other process-critical equipment and increase availability to levels that could result in running the plant based on market demand.

From assistance to action

The annual Full Service site assessment was completed at MEGA in early 2008. Site assessments identify initiatives that are performing well and also identify those that can be improved. Each assessment comes with recommendations to assist the ABB site team in closing those performance gaps that have been identified.

2 Equipment reliability trends a, where the goal was 99.6 percent, and customer satisfaction trends b, where the goal was a score of 4.0 out of a possible 5.0

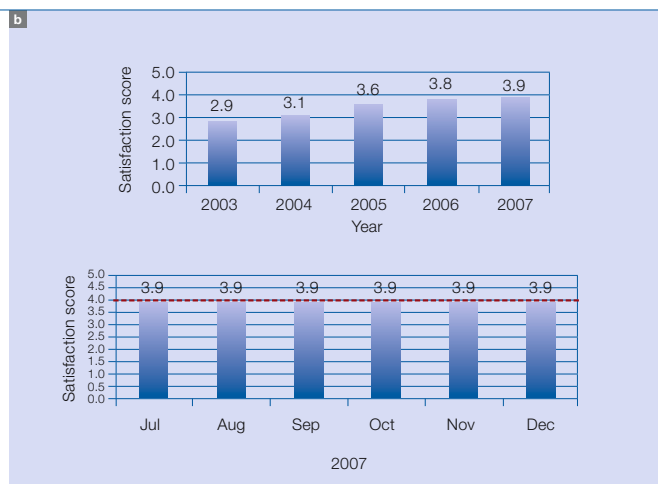
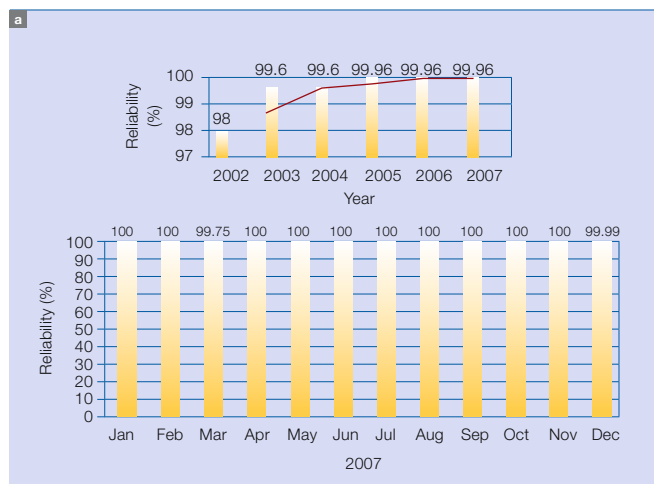

Sustainable results

While the site assessment process at MEGA was very effective, it became evident that more could be done to help the sites improve in both the quality and quantity of the “gap-closing” initiatives. This meant improving the execution of initiatives with the goal of improving client, ABB, and people value, mirroring the ABB Full Service results triangle **3**. This approach has been coined “post-assessment assistance” **Factbox 1**.

The key factor is to obtain control of failures by anticipating them early on and intervening with planned and scheduled approaches.

The post-assessment assistance develops a specific way forward, a road map unique to each site. It contains the objectives, goals and site-specific initiatives designed to close gaps in site performance and client expectations **4**.

Reliability in practice

For most individuals, reliability numbers, by themselves, lack meaning for making improvements, regardless whether the numbers are percentages, mean time between failures (MTBF) or fewer emergency work orders written. For business, the financial issue of reliability means controlling the cost

of unreliability from equipment and process failures, which waste money and impact production capacity.

From an engineering perspective, reliability is commonly quantified by determining the probability of a failure occurring. Attempts to measure probability involve the use of probabilistic and statistical methods and tools. Typical examples of reliability analysis used in gas plants include the use of different reliability tools, such as Weibull analysis, Pareto analysis and Monte Carlo simulation **Factbox 2**.

A key factor for reliability analysis is the quality of plant data – specifically, how the data is obtained, managed, and who is responsible for analyzing it. Most plants in the oil & gas industry have accumulated data for many years, but it is rare to find someone who is responsible for analyzing the data and for obtaining information that can be used in problem-solving exercises.

Plant data is an excellent means of showing what works, and also for showing improvement opportunities. A good approach for beginning the analysis is to locate the problems by examining the frequency of occurrence. The first tool to consult for a brief overview is the “top 10” Pareto chart. Pareto analysis is used to rank the opportunities and to focus on those with the highest values. The proverbial 80/20 rule applies: 80 per-

cent of the problems or losses are driven by 20 percent of the equipment or processes **5**.

Reliability analysis: mechanical seal in an NGL pump

Based on the Pareto analysis, the ABB engineering team chose to analyze the reliability of the NGL pump 510-P-01C. The team believed that the pump system had low reliability because the process condition had varied from the original design condition.

Typical examples of reliability analysis used in gas plants include the use of different reliability tools, such as Weibull analysis, Pareto analysis and Monte Carlo simulation.

Next, a search of the Computerized Maintenance Management System (CMMS) database on NGL pump 510-P-01C revealed that the most frequent failure mode was associated with mechanical seal failure.

It is often said in reliability professional circles that maintenance is managed at the failure-mode level. Failure mode is defined as any event that is likely to cause an asset (or system or process) to fail. Thus, a failure mode is an event that causes a functional failure in an asset. Common failure

3 The site assessment process is an effective tool used to ascertain not only current performance but is also highly effective in developing forward thinking strategies

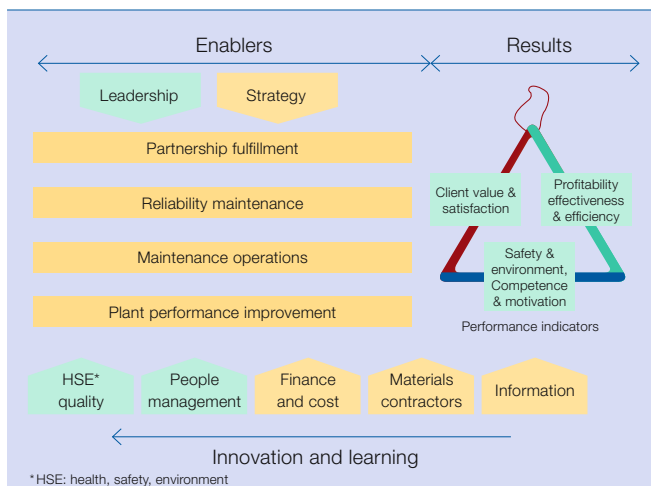

4 Post-assessment assistance

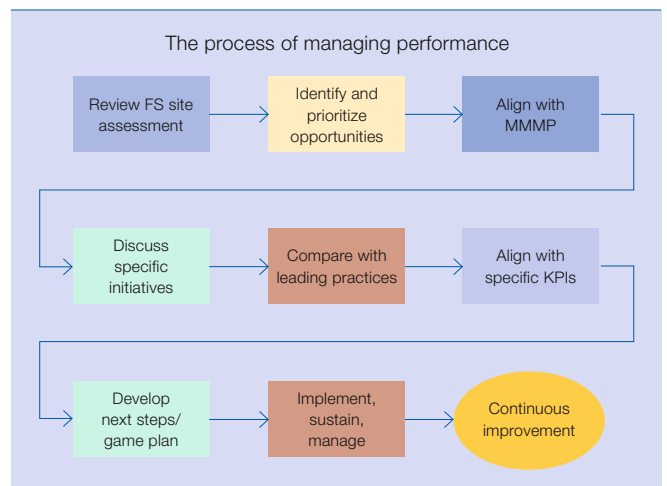

5 Pareto chart showing the top 10 improvement opportunities at MEGA. In June through August, equipment A accounted for 80 percent of the cost.

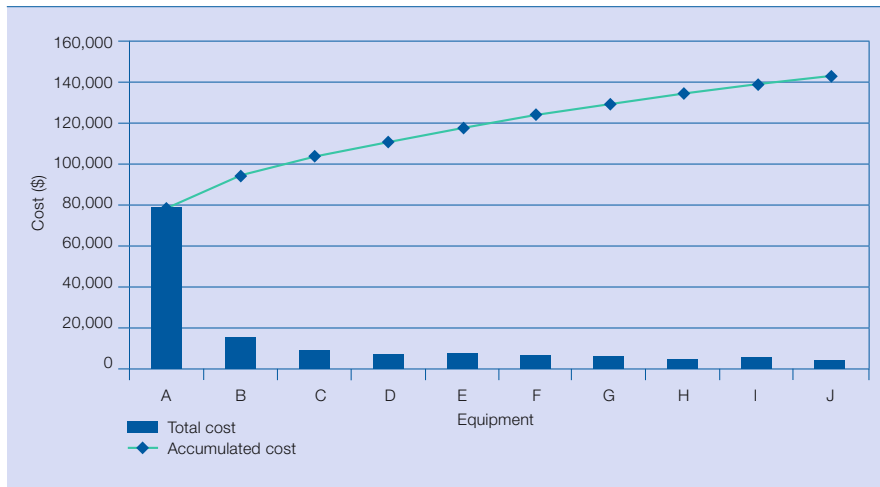

modes are: bearing seized, impeller jammed, motor burned out, and blocked suction line.

The NGL pump is a critical piece of equipment for the production process since it delivers the final processed product to the Bahia Blanca plant, where it is fractionated into other products (ethane, propane and butane). Based on the CMMS data collected for this pump, reliability application software was selected because of its capability to perform Weibull analysis. The equation used to calculate reliability is:

$$R_t = e^{-\left(\frac{t}{\eta}\right)^\beta}, t > 0$$

where:

R(t) = reliability value (0-1)

t = age of failure (hours, cycles)

η = scale parameter (hours, cycles)

β = shape parameter ($\beta < 1$; $\beta = 1$; $\beta > 1$)

The data collected from the CMMS database is shown in 6. Weibull analysis revealed the failure pattern results depicted in 7.

One of the advantages of using Weibull analysis is the fact that it provides a flexible modeling profile covering early-life, random, and wear-out failure patterns. For the mechanical seal, the MTBF is 8,518 hours, which indicates that 50 percent of the me-

6 NGL pump data collected from the CMMS database

Age (hours)	Failure (F) or suspension (S)
9,236	F
2,924	S
2,202	F
12,433	F
11,123	F
2,880	F

Preventive replacement cost (before failure) = \$4,258
 Mean time to repair (MTTR) = 5 hours
 Failure cost (lost production + replacement cost) = \$413,403

chanical pump seals fail before they reach 8,518 hours of operation, and 50 percent fail after 8,518 hours of operation. This analysis motivated the customer to upgrade the pump system by improving the mechanical seal.

Next, the ABB team performed a cost analysis to ascertain the optimal time to make a spare-part (mechanical-seal) replacement. 8 shows that the optimal time to replace the mechanical seal is at about 650 hours of operation, which would yield a per-hour operations savings of \$103. However, this replacement frequency was deemed impractical, so the ABB team

7 Reliability function of the NGL pump as demonstrated with Weibull analysis (two parameter, linear regression)

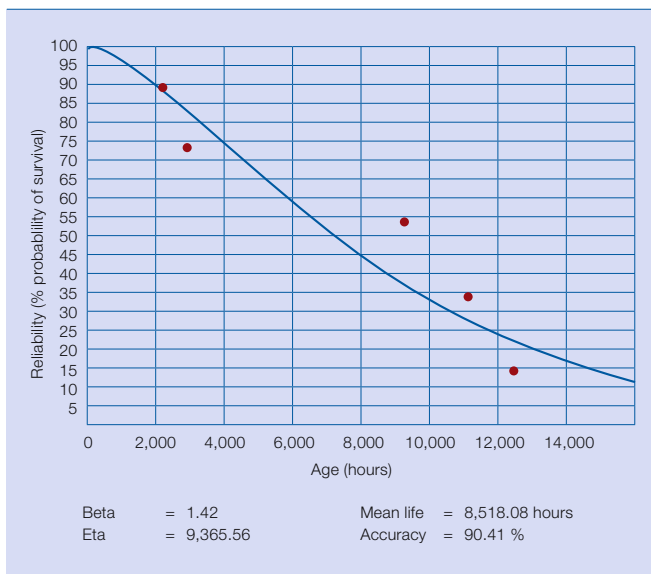

8 Replacement policy analysis

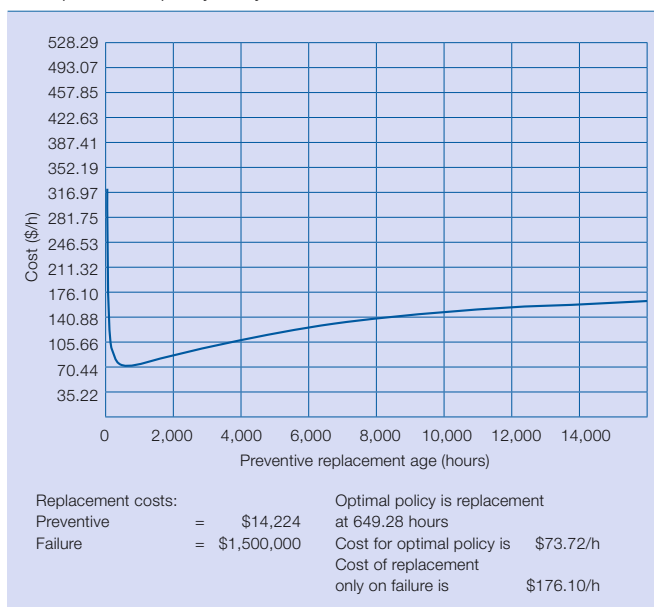

Replacement costs:
 Preventive = \$14,224
 Failure = \$1,500,000
 Optimal policy is replacement at 649.28 hours
 Cost for optimal policy is \$73.72/h
 Cost of replacement only on failure is \$176.10/h

Sustainable results

9 Actual plan the American Petroleum Institute (API) installed on pumps 11, and the new plan proposed by the API 12. Even process conditions can be changed: The pressure on the seal will be the design condition.

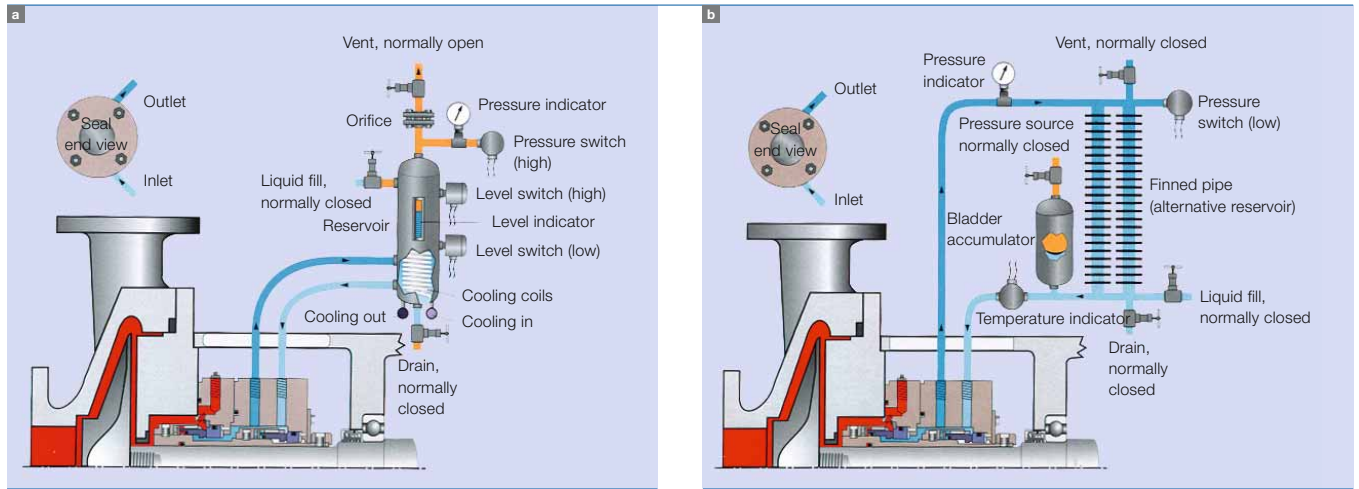

analyzed potential replacements at several different hours of operation.

The second analysis at 4,000 hours of operation resulted in a savings of \$66 per hour of operation. The team then performed a third analysis at 6,000 hours of operation, which yielded a cost savings of \$46 per hour. Finally, a fourth analysis at 8,000 hours of operation yielded a cost savings of \$36 per hour.

As a result of the Weibull analysis, the ABB team could make several recommendations. After careful consideration, MEGA and ABB agreed that a redesign or modification was preferred over implementing a maintenance strategy based on periodic replacement. The modification agreed upon was to install a pressurized system that would activate the mechanical seal 9.

The proverbial 80/20 rule applies: 80 percent of the problems or losses are driven by 20 percent of the equipment or processes.

The cost of the modification (two seals per pump) is approximately \$90,000. The reliability of the modification will be monitored by regular data analysis using the Weibull method, making it possible to determine

the improvement in reliability through extending the MTBF beyond the originally established baseline.

Weibull analysis of a screw compressor
The air screw compressor is classified as process-critical equipment. The function of the compressor is to supply oil with air for the plant instrumentation. What makes this a critical step in the production process is that, if air was not supplied, plant instrumentation would malfunction and lead to erroneous readings, resulting in production control variation.

Some unexpected failures occurred in the resistance temperature detector (RTD) sensor. The RTD is a device that measures the air temperature discharge; if it fails, the screw compressor stops. After performing root cause failure analysis (RCFA), the ABB team concluded that the main failure mode was caused by high vibration when the compressor was in operation.

The team then designed a device to absorb vibration, which thus should reduce failures 10 11. But the question remained: Did the modification reduce the vibration failure mode and im-

Factbox 1 Post-assessment assistance

After an ABB Full Service site successfully completes an assessment, the post-assessment assistance offering helps address the findings and recommendations designed to improve site performance. Each site receives a customized “way forward” strategy tailored to reflect its unique challenges and improvement opportunities. Then, the improvement opportunities are addressed in a logical, step-by-step plan. This process was used at MEGA and addressed one of the findings from the assessment, which was to improve the site’s approach to reliability. ABB worked with the MEGA site to understand how implementing reliability would benefit the site. The ABB site-reliability team then identified specific opportunities in which to apply a reliability-based improvement initiative.

Factbox 2 Reliability application software selection

Data analysis can be improved through the use of reliability software capable of statistical analysis. Reliability software was used in decision making for the three case studies in this article. Whatever reliability application software is selected should have the functionality to perform Weibull analysis. The Weibull method identifies or models the category of failure – early life, random, and wear out – based on the operating time (ie, equipment age) at which a component fails. Because Weibull analysis can fit most data better than other models and is effective in providing accurate failure analysis with relatively small data samples, it is the most widely used model for determining component reliability analysis and has emerged as the preferred method to model and analyze component failure patterns.

10 An anti-vibration device **a** **b** was placed on the RTD sensor **c** to reduce RTD failures.

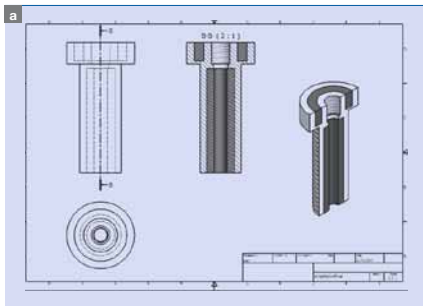

11 Failure in the RTD wire due to high vibration acting on the system



prove reliability? Weibull analysis was used to assess the level of reliability improvement.

With a pre-modification MTBF of 3,042 operating hours and a post-modification MTBF of 5,000 operating hours, the actual improvement is approximately 2,000 operating hours – a 19 percent MTBF improvement **12** **13**. The ABB team will monitor the MTBF for improvement and address the next predominant failure mode.

Reliability analysis of temperature transmitter

Temperature transmitters (TTs) control the temperature in process-sensitive automation controls. This equipment was selected as a result of numerous failures over the past year. The failures appeared to be random in nature (ie, no predominant failure pattern), making reliability improvements challenging.

Weibull analysis provides a flexible modeling profile covering early-life, random, and wear-out failure patterns.

The ABB team collected all failure data from the CMMS equipment history in order to perform a reliability analysis. Failure data pertaining to the TT was collected from the CMMS

system for the period from 2001 to 2008. Next, the team used the reliability application tool to model a reliability curve to identify any failure patterns **14**.

Simply plotting the data yielded some surprising results. The MTBF was calculated at 61 months or approximately 5 years. Looking at other similar equipment in the industry, a typical MTBF is between 25 and 150 years. The ABB team thus pursued further data analysis and testing of similar equipment in a laboratory setting. It was determined that the problem was actually inside the instrument and the root cause was the design from the original equipment manufacturer (OEM). This analysis led to a discussion between MEGA and the OEM, and resulted in MEGA receiving a credit for previous TT equipment failures and also provided data to the OEM for creating a new improved version.

12 Reliability function of RTD before modification (using two-parameter, maximum-accuracy Weibull analysis) **a**, and after modification (using two-parameter, linear-regression Weibull analysis) **b**.

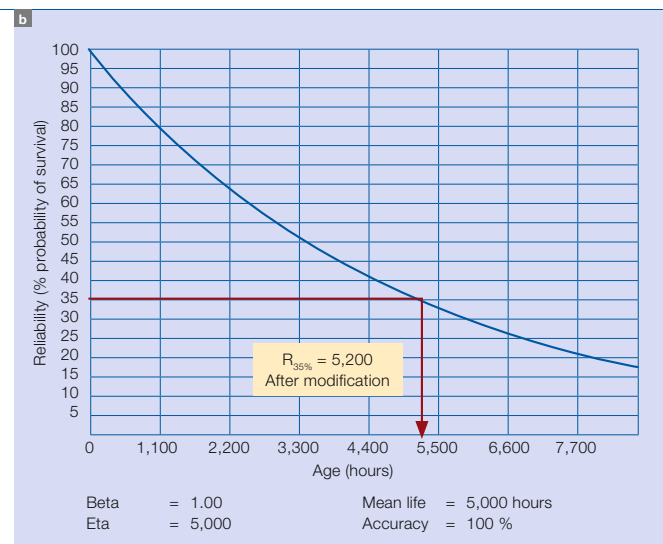
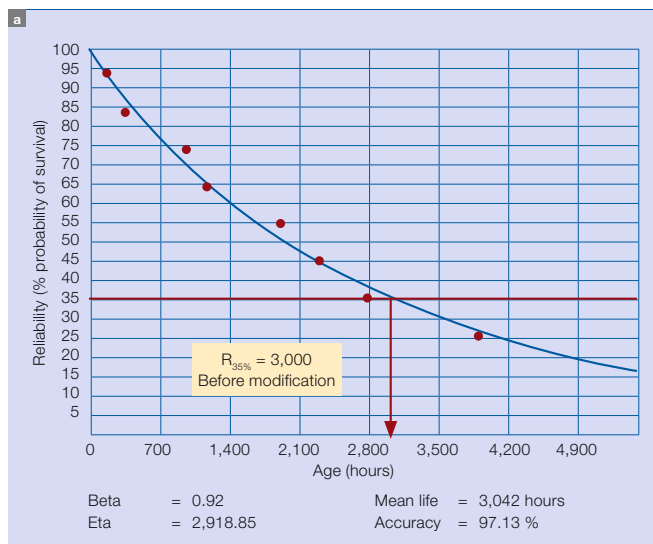

Sustainable results

High reliability is a high priority

The strong competitive environment between companies to secure business and the current world financial crisis are forcing organizations to explore ways to reduce operating costs. A popular approach is to reduce expenditures on equipment maintenance. However, this is very short sighted, as deferred investments often resurface and can cost two to five times more than if they had been addressed in the early stages of failure development.

Data analysis resulted in MEGA receiving a credit for previous TT equipment failures and also provided data to the OEM for creating a new improved version.

Timely maintenance of equipment with the subsequent improvement in reliability will reduce the overall cost of not only equipment unreliability but also process-related unreliability. Together, this approach will improve business performance and generate more profits, and can result in incremental business given the increase of production capacity resulting from higher production uptime or availability. Additionally, the higher production output will offset the cost of additional investment in equipment, thus lowering maintenance costs.

Various strategies and tools are available that can be used to assist in making the best maintenance and replacement decisions. The intent of these decisions is to determine the type of maintenance tactic required for preserving system function. In particular, utilizing reliability-based application software with Weibull functionality

13 Reliability curves comparison. After modifying the RTD sensor, the MTBF improved by 19 percent.

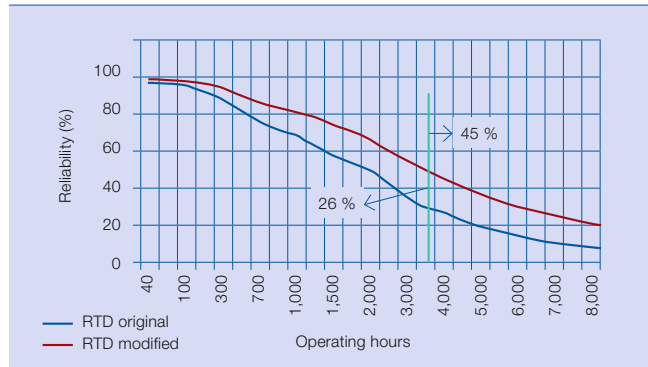

14 TT reliability curve

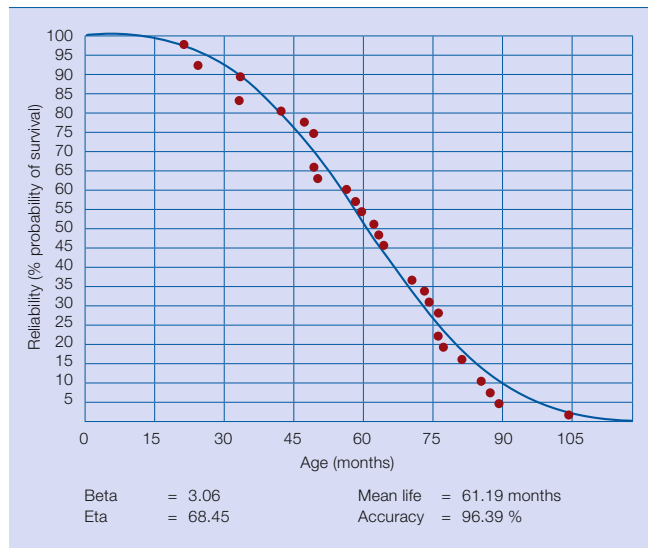

can yield improved objective decision-making capabilities.

Deferred investments often resurface and can cost two to five times more than if they had been addressed in the early stages of failure development.

To truly compete in a global environment, an organization needs not only high equipment availability, but also high equipment reliability. Knowing what equipment management tactic to deploy can be challenging given choices between preventive maintenance replacement intervals, inspection frequencies, condition-based maintenance actions, capital equip-

ment replacement and maintenance resource requirements. Selecting the optimal maintenance approach can increase the likelihood of realizing lower operating costs and higher levels of reliability and availability, resulting in more reliable production. The optimal approach can support initiatives designed to deliver positive results in client, people and ABB value.

Fernando Vicente
Hector Kessel
 ABB Full Service®
 Buenos Aires, Argentina
 fernando.vicente@ar.abb.com
 hector.kessel@ar.abb.com

Richard M. Rockwood
 ABB Process Automation Full Service,
 Oil, Gas, and Petrochemical
 Minneapolis, MN, USA
 richard.m.rockwood@us.abb.com

Further reading
Desaegher, J. (2008). Outsourced maintenance: The ABB Full Service® solution. *ABB Review Special Report: Process Automation Services and Capabilities*, 79–83.
Kleine, B. What is reliability? Changing the reliability paradigm. *ABB Review* 1/2009, 34–37.